

EPM12V2

Non-isolated DC-DC converter



Product features

- Non-isolated DC-DC converter
- 3 - 14.4 Vdc input voltage range
- Efficiency up to 91%
- Operating ambient temperature from -40 °C to +90 °C
- Short circuit protection and remote ON/OFF function
- Programmable output voltage from 0.6 - 5.5 Vdc
- EN62368 safety approval

Engineering tools

- EPM12V2 Evaluation kit available (2 options)
- PN: EPM12V2-P-EVK (Positive logic version)
Includes evaluation board with EPM12V2 sample
- PN: EPM12V2-N-EVK (Negative logic version)
Includes evaluation board with EPM12V2 sample
- [EPM12V2 Evaluation kit user guide](#)

Applications

- Industrial
 - Automation & testing equipment
 - Displays
 - Lighting
 - IoT
 - Power Supply
- Energy
 - Solar and wind inverters
 - Battery management
- Medical
 - Hospital & home care equipment
 - Inventory tracking
 - Diagnostics
- Telecom
 - Networking and telecommunications
 - Infrastructure

Environmental compliance



Ordering part number

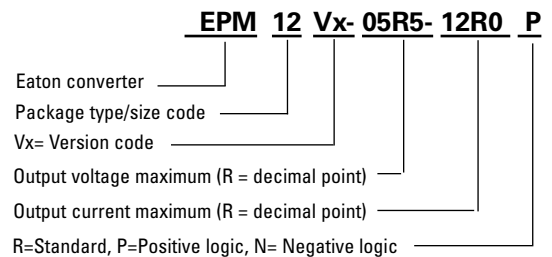

Powering Business Worldwide



Specifications

	Parameter	Conditions	Minimum	Typical	Maximum	Unit
Input	Input voltage range		3	12	14.4	Vdc
	Start-up voltage	0%~100% load			3	Vdc
	VULO		2.6			V
	Remote ON/OFF	Positive	DC-DC ON DC-DC OFF	Open or $1.6\text{ V} \leq V_{on/off} \leq 5.5\text{ V}$ Short to Gnd or $0\text{ V} \leq V_{on/off} \leq 0.6\text{ V}$		
	Negative	DC-DC ON DC-DC OFF	Short to Gnd or $0\text{ V} \leq V_{on/off} \leq 0.6\text{ V}$ $1\text{ V} \leq V_{on/off} \leq 5.5\text{ V}$			
Output	Efficiency	$V_o = 5\text{ Vdc}$		91		%
		$V_o = 3.3\text{ Vdc}$		88		%
		$V_o = 2.5\text{ Vdc}$		86		%
		$V_o = 1.8\text{ Vdc}$		82.5		%
		$V_o = 1.2\text{ Vdc}$		77		%
		$V_o = 0.6\text{ Vdc}$		65		%
	Output voltage trim ¹		0.6		5.5	Vdc
	Minimum load		0			%
	Line regulation	LL-HL			±0.4	%
	Load regulation	10-100% Load			±0.2	%
	Voltage accuracy			±0.3		%
	Operating frequency	100% Load at nominal V_{in}		800		kHz
	Ripple & noise ²	$V_o \leq 1.2\text{ Vdc}$		30		mVp-p
		$V_o > 1.2\text{ Vdc}$		3% V_o		mVp-p
	Power good	Overvoltage threshold for PGOOD ON		116.5		%
Overvoltage threshold for PGOOD OFF			120		%	
Undervoltage threshold for PGOOD ON			91		%	
Undervoltage threshold for PGOOD OFF			87		%	
PGOOD low sink current @VPGOOD = 0.2 V			100		µA	
Environment	Operating temperature	With derating	-40		+90	°C
	Storage temperature		-55		+125	°C
	Relative humidity				95	%RH
	Vibration			MIL-STD-202G		
Function	Short circuit protection		Continuous, automatic recovery			
	Safety		EN 62368-1			
	MTBF	MIL-HDBK217F	1132			khours
Frequency synchronization	Synchronization frequency range ³			800	840	kHz
	High-level input voltage		2			V
	Low-level input voltage				0.8	V
	Input current, SYNC			1		µA
Physical	Dimension		0.480 (L) x 0.480 (W) x 0.122 (H)			inches
	Weight		0.8			g
	Case material		Open frame			
	Cooling method		Free air convection			
EMC	EMI	EN 55032	Class A			
	ESD	EN61000-4-2 Air ± 8 kV Contact ± 8 kV	Criteria B			
	Fast transient	EN 61000-4-4, ±2 kV	Criteria B			
	Surge	EN 61000-4-5, ±2 kV	Criteria A			

1. The output voltage range is limited by V_{in} . ($V_{out} \leq V_{in} - 2\text{ Vdc}$)
 2. The ripple & noise are measured with 47 µF + 47 µF + 0.1 µF capacitor at 20 MHz BW.
 3. SYNC frequency must be greater than operating frequency, externally tie SYNC to GND if synchronization functionality not required.
 4. All specifications valid at nominal input voltage, full load and +25 °C after warm-up time unless otherwise stated.
 5. The product information and specifications are subject to change without prior notice.

Selection guide

Part number	Input voltage	Output voltage	Output current @ full load	Input current @ no load	Efficiency ¹ typical	Capacitive load ² maximum	ON/OFF Logic
EPM12V2-05R5-12R0P	3 - 14.4 Vdc	0.6 - 5.5 Vdc	12 A	30 mA	91%	200 µF	Positive
EPM12V2-05R5-12R0N	3 - 14.4 Vdc	0.6 - 5.5 Vdc	12 A	30 mA	91%	200 µF	Negative

1. The no load input current is test by 0.6 V output.
2. The efficiency is test by nominal input, 5 Vout and full load @ +25 °C.
3. The capacitive load is test by minimum input and constant resistive load
4. All specifications valid at 12 V input, full load and +25 °C after warm-up time unless otherwise stated.

Measure method

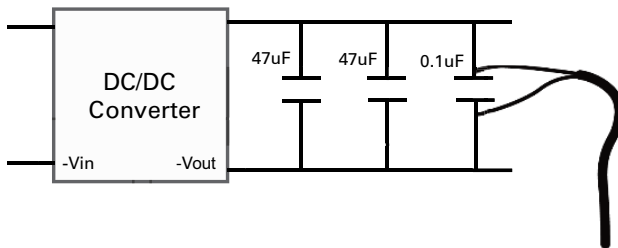

Derating curve

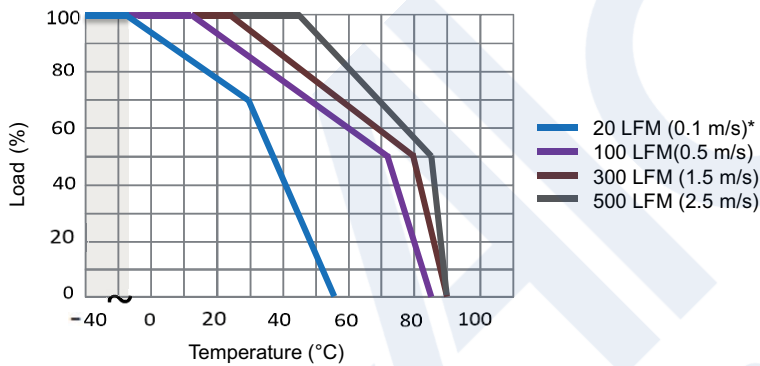

The derating curve was measured at 12 V input and 5 V output.
* The derating curve is at 7 V input and 5 V output

Output voltage vs. input voltage

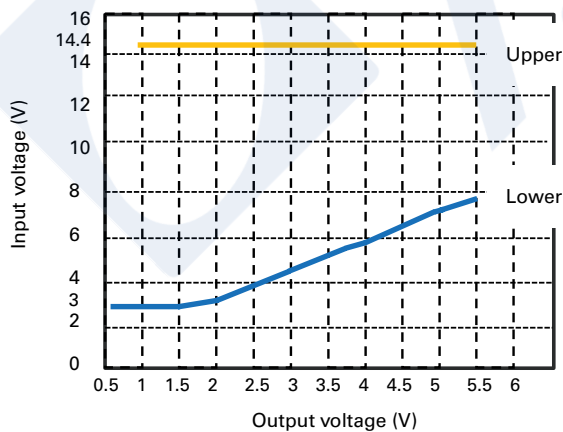

Application information

Output voltage trim

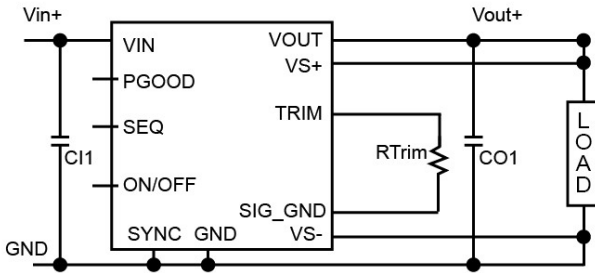

Trim resistor equation

$$R_{trim} (k\Omega) = \frac{12K}{V_o - 0.6}$$

Output voltage	Calculated Rtrim (kΩ)
5.0 V	2.727
3.3 V	4.444
2.5 V	6.316
1.8 V	10
1.5 V	13.3
1.2 V	20
0.6 V	∞ (Open)

Power good

Power good monitor output. This open-drain output goes low during overcurrent, short-circuit, UVLO, overvoltage and undervoltage, or when the output is not regulated (such as a pre-bias output). An external pullup resistor to VDD or to an external rail is required. Included is a 20-μs deglitch filter. PGOOD pin can be connected through a pullup resistor suggested value 100 kΩ) to a source of 5 Vdc or lower.

Synchronization

The module switching frequency can be synchronized to a signal with an external frequency within a specified range. Synchronization can be done by using the external signal applied to the SYNC pin of the module, with the converter being synchronized by the rising edge of the external signal. The electrical specifications table specifies the requirements of the external SYNC signal. If the SYNC pin is not used, the module should free run at the default switching frequency. If synchronization is not being used, connect the SYNC pin to GND.

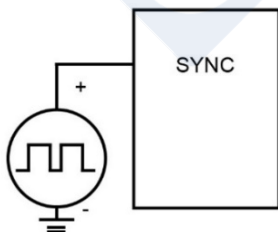

Output voltage sequencing

The SEQ pin can be used when master-slave power-supply tracking is required.

The voltage applied to the SEQ pin should be scaled down by the same ratio as used to scale the output voltage down to the reference voltage of the module. This is accomplished by an external resistive divider connected across the sequencing voltage before it is fed to the SEQ pin.

The minimum recommended delay between the ON/OFF signal and the sequencing signal is 10 ms to ensure that the module output is ramped up according to the sequencing signal. This ensures that the module soft-start routine is completed before the sequencing signal is allowed to ramp up.

When an analog voltage is applied to the SEQ pin, the output voltage tracks this voltage until the output reaches the set-point voltage. The final value of the SEQ voltage must be set higher than the set-point voltage of the module. The output voltage follows the voltage on the SEQ pin on a one-to-one basis. By connecting multiple modules together, multiple modules can track their output voltages to the voltage applied on the SEQ pin.

To initiate simultaneous shutdown of the modules, the SEQ pin voltage is lowered in a controlled manner. The output voltage of the modules tracks the voltages below their setpoint voltages on a one-to-one basis. A valid input voltage must be maintained until the tracking and output voltages reach ground potential.

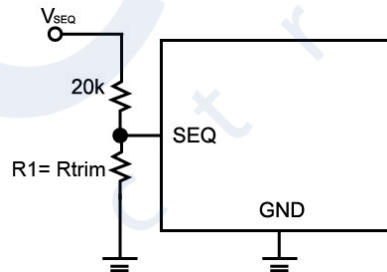

The SEQ pin can be used when master-slave power-supply tracking is required

Remote ON/OFF

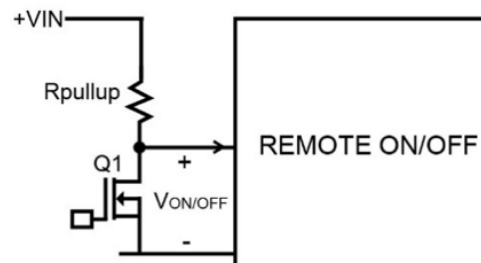

Logic type active mode

Positive Logic

DC/DC ON : Q1 OFF

DC/DC OFF : Q1 ON

Negative Logic

DC/DC ON : Q1 ON

DC/DC OFF : Q1 OFF

EMC filtering circuit

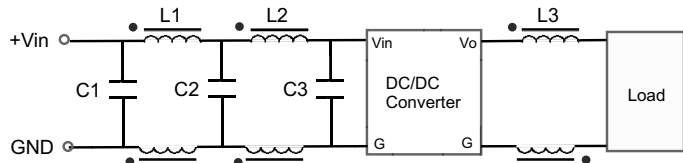

Class	C1	L1	C2	L2	C3	L3
Class A	100 μ F / 25 V	8 mH	100 μ F / 25 V	12 mH	470 μ F / 25 V	35 μ H

ETF and surge circuit

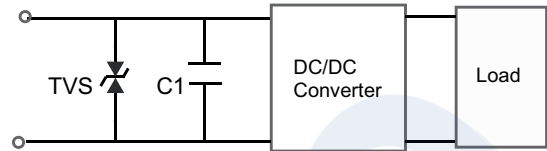

TVS	C1
Eaton P4SMA13CA	10000 μ F 25 V

Mechanical dimension and pinning - inches

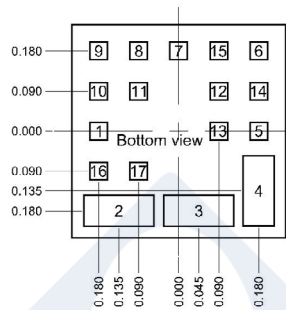
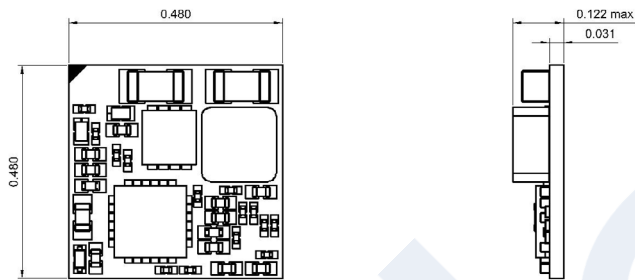

Projection: Third angle projection
Tolerance: ± 0.01
Pad 1&5~12 = 0.04 x 0.04
Pad 2~4 = 0.07 x 0.157

Pin	Function	Pin	Function
1	On/Off	10	PGOOD
2	Vin	11	SYNC
3	GND	12	VS-
4	Vout	13	SIG_GND
5	VS+ (Sense)	14	NC
6	TRIM	15	NC
7	GND	16	NC
8	NC	17	NC
9	SEQ		

NC = no connection

Recommended pad layout

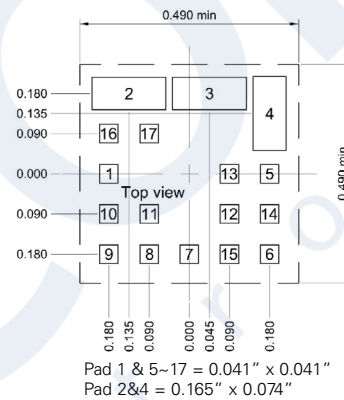

Marking

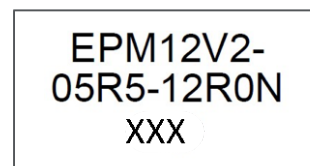

xxx= lot code

Packaging- Inches

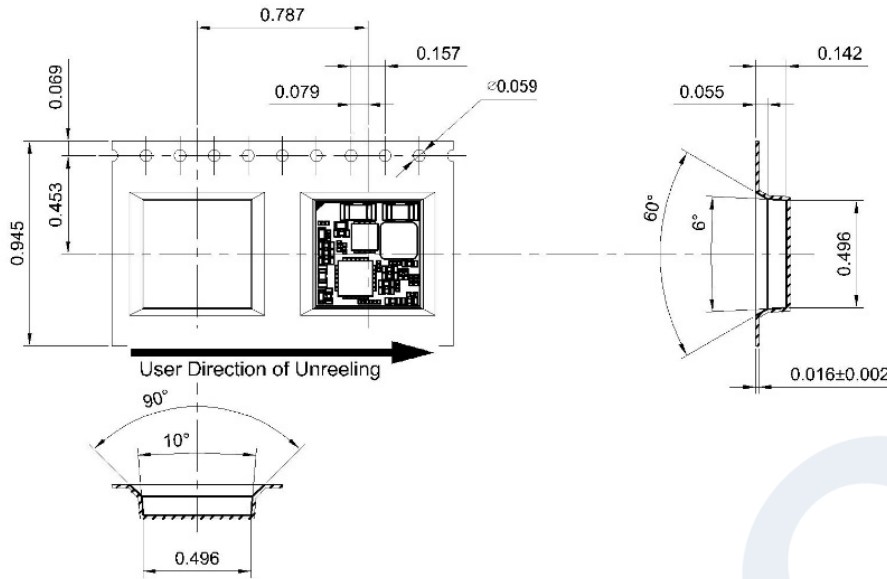

- 1). 10 sprocket hole pitch cumulative tolerance ± 0.008 inch.
- 2). All dimensions meet EIA-481-2A requirements.
- 3). Component loader per 13" reel : 850 pcs.
- 4). All dimensions = ± 0.004 inch.

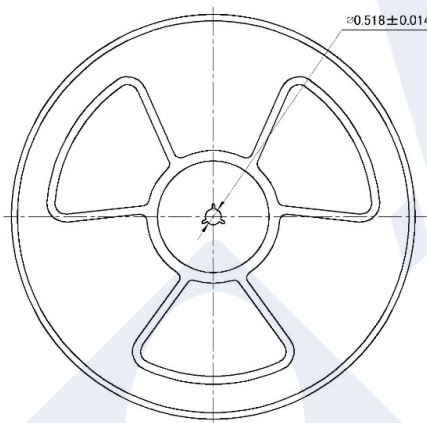

Unit : inch
Package : 1 Tape Reel = 850 pcs

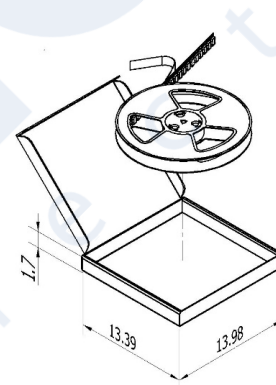
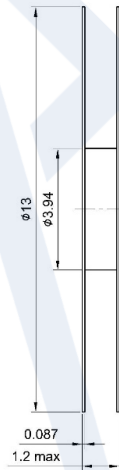

1 Tape Reel = 850 converters

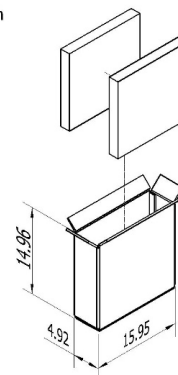

Carton accommodates
2 boxes 1700 converters per carton

General information

Pick and place

The 12 A open frame modules use an open frame construction and are designed for a fully automated pick and place assembly process.

MSL rating

The 12 A Open frame modules have a MSL rating of 3.

Storage and handling

The recommended storage environment and handling procedures for moisture-sensitive surface mount packages is detailed in J-STD-033 (Handling, packing, shipping and use of moisture/reflow sensitive surface mount devices).

Moisture barrier bags (MBB) with desiccant are required for MSL ratings of 3 or greater. These sealed packages should not be broken until time of use. Once the original package is broken, the floor life of the product at conditions of 30 °C and 60% relative humidity 168 hours varies according to the MSL rating (see J-STD-033). The shelf life for dry packed SMT packages will be a maximum of 12 months from the bag seal date, when stored at the following conditions: < 40 °C, < 90% relative humidity.

Post solder cleaning and drying considerations

To avoid contamination on the soldering pads extra care has to be taken when handling the boards. Clean soldering surfaces do not generate as many gases when the flux reduce the metal oxides or react with contaminants during the soldering process.

Nozzle

The module weight has been kept to a minimum by using open frame construction. Variables such as nozzle size, tip style, vacuum pressure and placement speed should be considered to optimize this process.

Lead-free reflow profile

Power systems will comply with J-STD-020 (Moisture/reflow sensitivity classification for nonhermetic solid state surface mount devices) for both Pb-free solder profiles and MSL classification procedures. This standard provides a recommended forced-air-convection reflow profile based on the volume and thickness of the package. The suggested Pb-free solder paste is Sn/Ag/Cu (SAC). The recommended linear reflow profile using Sn/Ag/Cu solder is shown. Soldering outside of the recommended profile requires testing to verify results and performance.

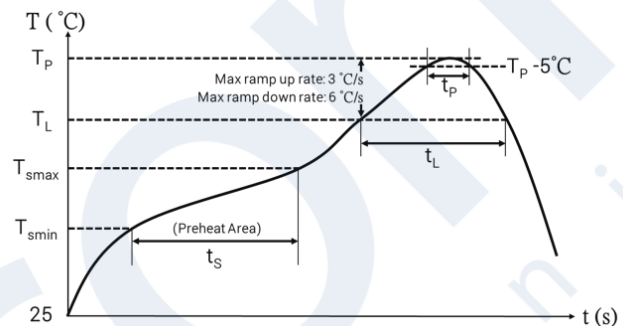

Profile	Pb-free assembly
Average ramp-up rate (T_{smax} to T_p)	3 °C/s max.
Preheat	
Temperature Min. (T_{smin})	150 °C
Temperature Max. (T_{smax})	200 °C
T_s (T_{smin} to T_{smax})	60-120 s
Temperature (T_p)	245°C
Time maintained above Temperature (T_l)	217°C
Time (t_l)	60-150 s
Time within 5°C of the specified Peak temperature (T_p)	20-40 s
Ramp down rate (T_p to T_l)	6 °C/s max
Time 25 °C to peak temperature	8 minutes max.

Life Support Policy: Eaton does not authorize the use of any of its products for use in life support devices or systems without the express written approval of an officer of the Company. Life support systems are devices which support or sustain life, and whose failure to perform, when properly used in accordance with instructions for use provided in the labeling, can be reasonably expected to result in significant injury to the user.

Eaton reserves the right, without notice, to change design or construction of any products and to discontinue or limit distribution of any products. Eaton also reserves the right to change or update, without notice, any technical information contained in this bulletin.

Eaton
Electronics Division
1000 Eaton Boulevard
Cleveland, OH 44122
United States
Eaton.com/electronics

© 2021 Eaton
All Rights Reserved
Printed in USA
Publication No. 11183
May 2021

Eaton is a registered trademark.

All other trademarks are property of their respective owners.

Follow us on social media to get the latest product and support information.

