

CSSA

Automotive grade current sense resistor- metal shunt

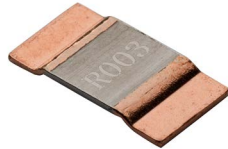

Product features

- AEC-Q200
- Resistance value from 0.2 mΩ to 5.0 mΩ
- Low thermal EMF
- Low TCR
- 2512 (6432 metric) to 5930 (15077 metric) package
- Moisture sensitivity level (MSL): 1

Applications

- Automotive lighting
- Server
- Battery management
- Hot swap controllers
- Body control modules
- DC/DC converters
- Switched-mode power supplies (SMPS)
- DC Motor control
- IoT devices
- Electric water pump
- Active braking

Environmental compliance

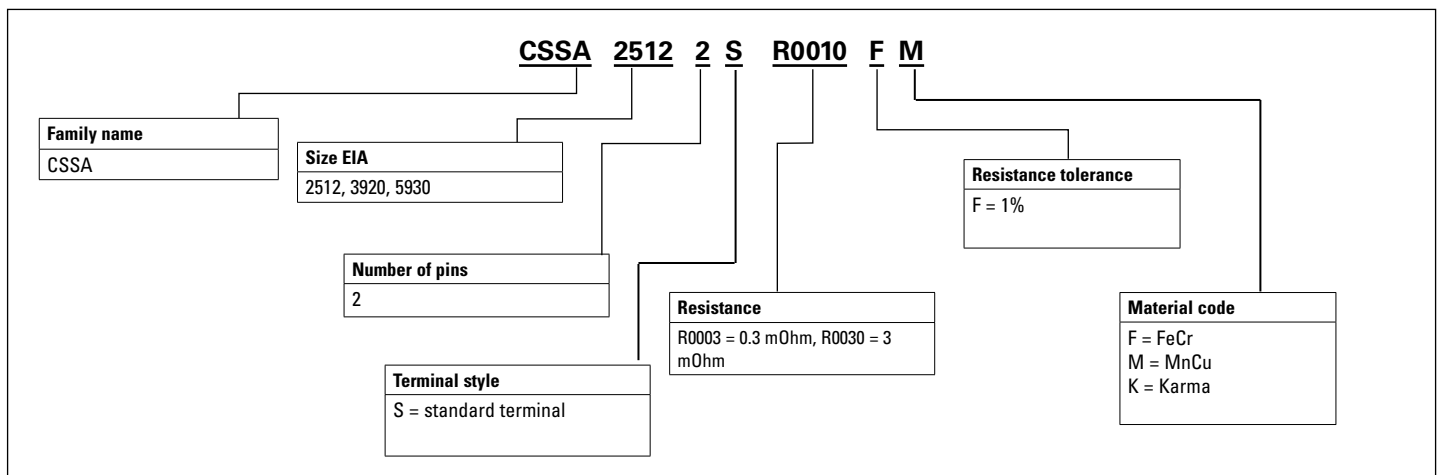
**Table 1. Part numbering**

Mechanical parameters- mm

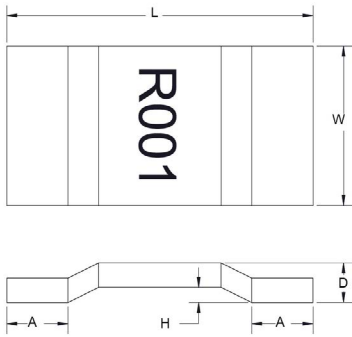

Construction

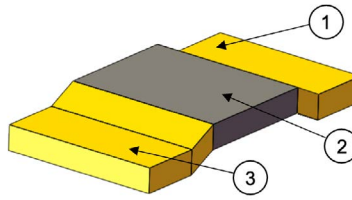

Number	Materials
1	Copper electrode
2	FeCr/ MnCu/ Karma
3	Copper electrode

Family	Size code	L	W	R	H	D
CSSA2512	2512 (6432 metric)	6.40 ± 0.20	3.20 ± 0.25	1.20 ± 0.20	0.50 ± 0.10	1.50 maximum
CSSA3920	3920 (10052 metric)	10.00 ± 0.30	5.20 ± 0.30	2.00 ± 0.30	0.50 ± 0.10	2.40 maximum
CSSA5930	5930 (15077 metric)	15.00 ± 0.30	7.70 ± 0.30	4.20 ± 0.30	0.50 ± 0.10	2.20 maximum

Recommended PCB layout

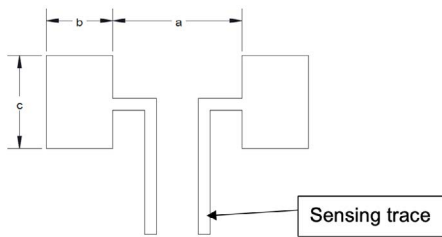

Family	a	b	c
CSSA2512	3.7	2.35	3.6
CSSA3920	5.6	2.7	6.2
CSSA5930	5.6	5.2	8.75

Part marking

Part marking	Resistance (mΩ)
0L20	0.2
0L30	0.3
0L50	0.5
R001	1
R002	2
R003	3
R004	4
R005	5

Electrical specifications

Part number	Size	Power rating @ +125 °C (W)	Resistance ² (mΩ)	Resistance tolerance	Material	TCR ¹ (ppm/°C)	Operating temperature
CSSA25122SR0010FM	2512 (6432 metric)	5	1	±1%	MnCu	± 150	-55 °C to +170 °C
CSSA25122SR0020FF	2512 (6432 metric)	5	2	±1%	FeCr	± 75	-55 °C to +170 °C
CSSA39202SR0002FM	3920 (10052 metric)	12	0.2	±1%	MnCu	± 150	-55 °C to +170 °C
CSSA39202SR0003FM	3920 (10052 metric)	9	0.3	±1%	MnCu	± 150	-55 °C to +170 °C
CSSA39202SR0005FM	3920 (10052 metric)	9	0.5	±1%	MnCu	± 150	-55 °C to +170 °C
CSSA39202SR0010FM	3920 (10052 metric)	9	1	±1%	MnCu	± 150	-55 °C to +170 °C
CSSA39202SR0010FK	3920 (10052 metric)	9	1	±1%	Karma	± 75	-55 °C to +170 °C
CSSA39202SR0010FF	3920 (10052 metric)	5	1	±1%	FeCr	± 75	-55 °C to +170 °C
CSSA39202SR0020FF	3920 (10052 metric)	5	2	±1%	FeCr	± 75	-55 °C to +170 °C
CSSA39202SR0030FF	3920 (10052 metric)	5	3	±1%	FeCr	± 75	-55 °C to +170 °C
CSSA39202SR0040FF	3920 (10052 metric)	5	4	±1%	FeCr	± 50	-55 °C to +170 °C
CSSA39202SR0050FF	3920 (10052 metric)	5	5	±1%	FeCr	± 50	-55 °C to +170 °C
CSSA59302SR0002FM	5930 (15077 metric)	15	0.2	±1%	MnCu	± 150	-55 °C to +170 °C
CSSA59302SR0003FM	5930 (15077 metric)	10	0.3	±1%	MnCu	± 150	-55 °C to +170 °C
CSSA59302SR0005FM	5930 (15077 metric)	10	0.5	±1%	MnCu	± 150	-55 °C to +170 °C
CSSA59302SR0010FF	5930 (15077 metric)	10	1	±1%	FeCr	± 75	-55 °C to +170 °C
CSSA59302SR0020FF	5930 (15077 metric)	7	2	±1%	FeCr	± 75	-55 °C to +170 °C
CSSA59302SR0030FF	5930 (15077 metric)	7	3	±1%	FeCr	± 75	-55 °C to +170 °C

1. Temperature coefficient of resistance (TCR) parameters: +25 °C to +125 °C
 2. Resistance should be measured at +23 °C ±5 °C in accordance with the recommended land pattern.

Packaging information- mm

Supplied in tape and reel on a 13" diameter reel

Part number	Qty/Reel
CSSA25122SR0010FM	4000
CSSA25122SR0020FF	4000
CSSA39202SR0002FM	1500
CSSA39202SR0003FM	1500
CSSA39202SR0005FM	1500
CSSA39202SR0010FM	1500
CSSA39202SR0010FK	1500
CSSA39202SR0010FF	1500
CSSA39202SR0020FF	2500
CSSA39202SR0030FF	2500
CSSA39202SR0040FF	2500
CSSA39202SR0050FF	2500
CSSA59302SR0002FM	1000
CSSA59302SR0003FM	1000
CSSA59302SR0005FM	2000
CSSA59302SR0010FF	1000
CSSA59302SR0020FF	2000
CSSA59302SR0030FF	2000

Tape carrier and dimensions

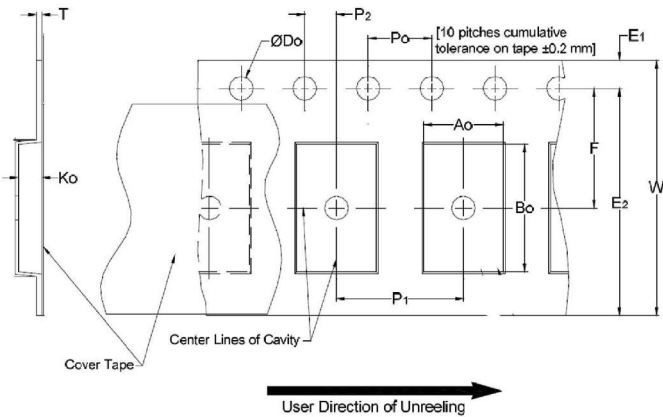

Dimension	CSSA2512	CSSA3920	CSSA5930
W	16.00 ± 0.30	24.00 ± 0.30	24.00 ± 0.30
F	7.50 ± 0.10	11.50 ± 0.10	11.50 ± 0.10
E1	1.75 ± 0.10	1.75 ± 0.10	1.75 ± 0.10
E2	NA	NA	NA
P0	4.00 ± 0.10	4.00 ± 0.10	4.00 ± 0.10
P1	8.00 ± 0.10	8.00 ± 0.10	12.00 ± 0.10
P2	2.00 ± 0.05	2.00 ± 0.05	2.00 ± 0.05
∅D0	1.50 ± 0.10	1.50 ± 0.10	1.50 ± 0.10
A0	3.50 ± 0.20	6.00 ± 0.20	8.60 ± 0.20
B0	6.80 ± 0.20	10.60 ± 0.20	15.60 ± 0.20
K0	1.40 ± 0.10	1.20/2.50	1.20/2.35
T	0.40 ± 0.10	0.40 ± 0.10	0.40 ± 0.10

Reel dimensions

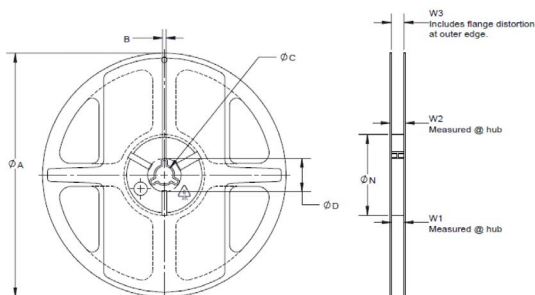

Shape & Appearance For Reference Only

Size	A	B	C	D	N	W1	W2	W3
CSSA2512	330 ± 2.0	2.0 ± 0.5	13.5 ± 1.0	20.2 minimum	60 ± 1.0	17.0 ± 0.5	22.4 maximum	NA
CSSA3920	330 ± 2.0	2.3 ± 0.5	13.0 ± 1.0	20.2 minimum	100 ± 1.5	24.5 ± 1.5	30.4 maximum	NA
CSSA5930	330 ± 2.0	2.3 ± 0.5	13.0 ± 1.0	20.2 minimum	100 ± 1.5	24.5 ± 1.5	30.4 maximum	NA

General specifications

Temperature coefficient of resistance: MIL-STD-202, Method 304, $TCR = (R-R_0)/R_0(T_2-T_1)*106$. Test temperature: $T_1=+25\text{ }^\circ\text{C}$, $T_2=+125\text{ }^\circ\text{C}$
Short time overload: IEC60115-1 4.13, 5 X rated power for 5 s
High temperature storage: MIL-STD202 Method 108, 1000 hours, $+170\text{ }^\circ\text{C}$, unpowered
Temperature cycling: JESD22 Method JA-104, 1000 Cycles, $-55\text{ }^\circ\text{C}$ (15 minutes), $+150\text{ }^\circ\text{C}$ (15 minutes)
Biased humidity: MIL-STD-202 Method 103, 1000 hours, $+85\text{ }^\circ\text{C}/85\%$ RH, 10% bias
Operational life: MIL-STD-202 Method 108, 1000 hours, $+125\text{ }^\circ\text{C} \pm 2\text{ }^\circ\text{C}$ at rated power, 1.5 hours on, 0.5 hours off.
Resistance to solvents: MIL-STD-202 Method 215, Immersed in three solvents after 3 to 3.5 minutes immersion, brush wipe 10 times, a total of 3 times, washing with washing and cleaning agent, room temperature on the surface of the ventilation drying.
Mechanical shock: MIL-STD-202 Method 213, 100 g's. 6 ms, 5 pulses
Vibration: MIL-STD-202 Method 204, 10 Hz to 2000 Hz, 5 g's for 20 min., 12 cycles each of 3 orientations
Resistance to soldering heat: MIL-STD-202 Method 210, Immerse the specimens in and eutectic solder at $+260 \pm 5\text{ }^\circ\text{C}$ for $10 \pm 0.5\text{ s}$
ESD: AEC-Q200-002 or ISO/DIS 10605, 25 kV
Solderability: J-STD-002, solder bath at $245 \pm 5\text{ }^\circ\text{C}$, Dipping time: 3 ± 0.3 seconds, > 95% area covered with tin
Board flex (bending): AEC-Q200-005, Bending amplitude 2 mm for 60 s
Terminal strength: AEC-Q200-006, Force of 17.7 N for 60 seconds

Temperature derating curve

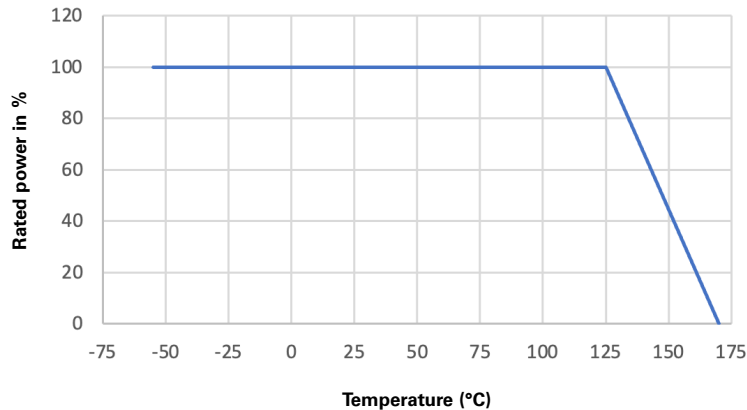

Rated current & voltage

The rated Current and Voltage are calculated by the following formula:

$$I = \sqrt{P \div R}$$

I: Rated current (A)

P: Rated power (W)

$$V = \sqrt{P \times R}$$

V: Rated voltage (V)

R: Resistance value (Ω)

Curves

Maximum pulse power

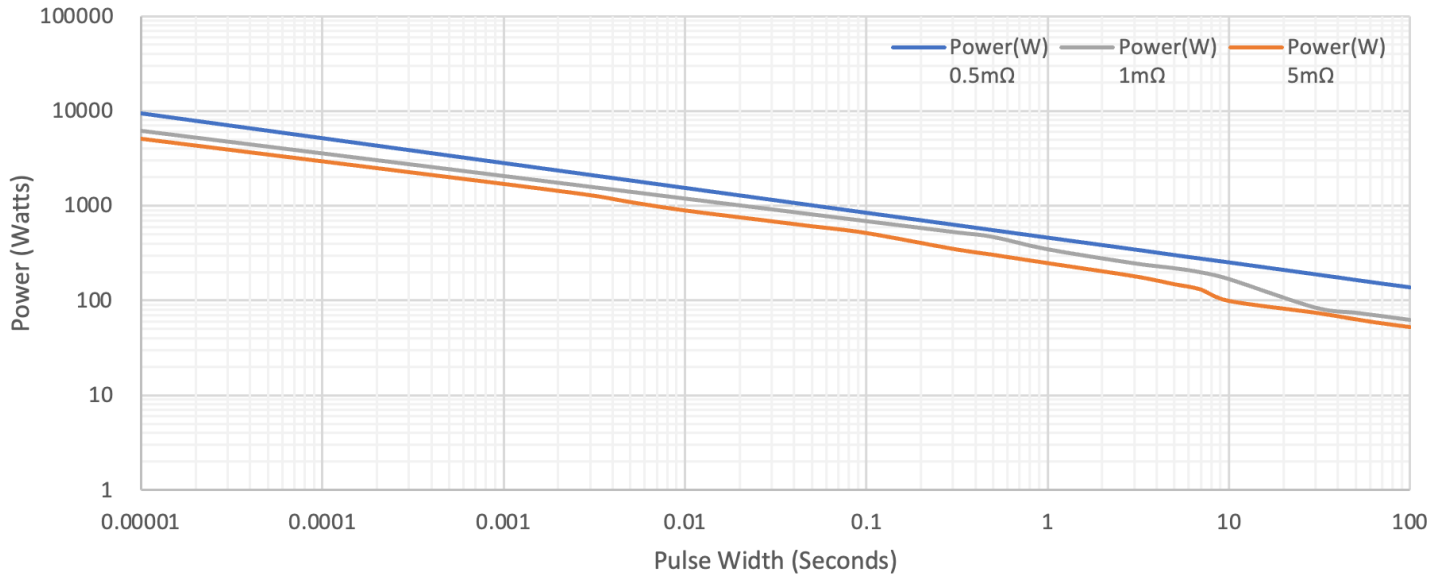

Maximum pulse energy

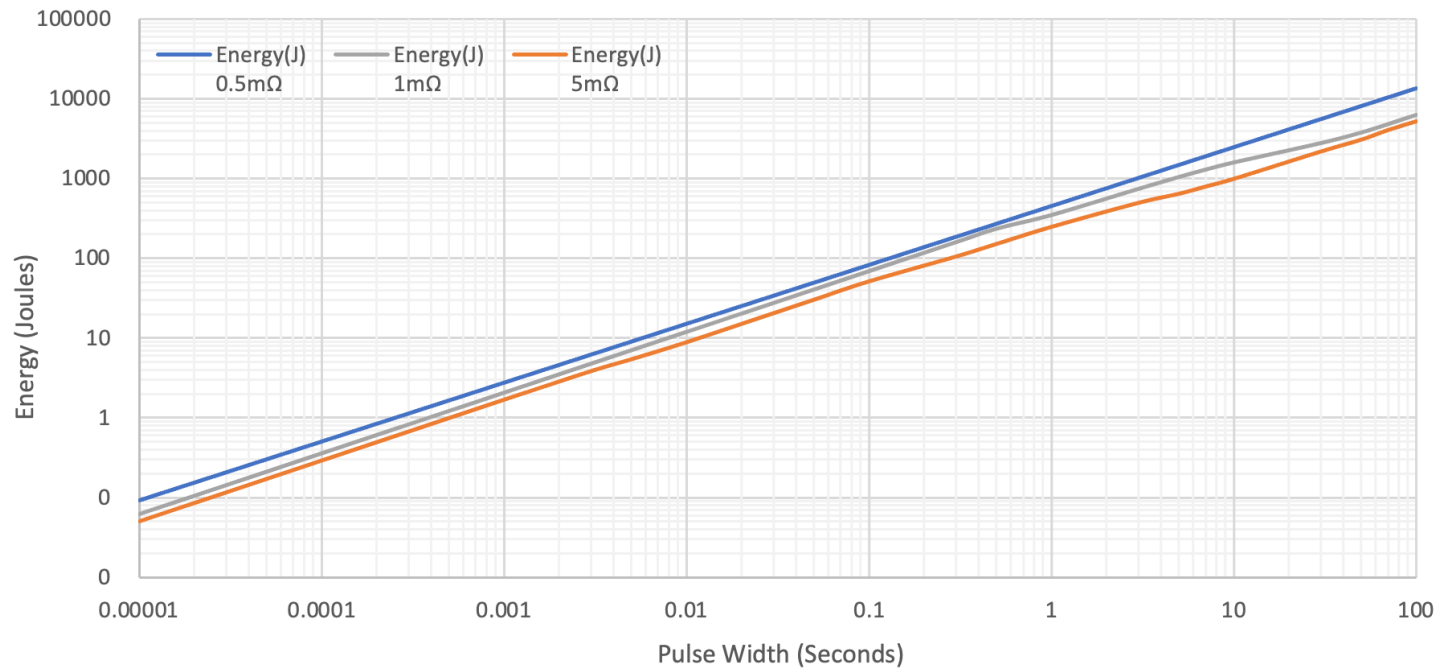

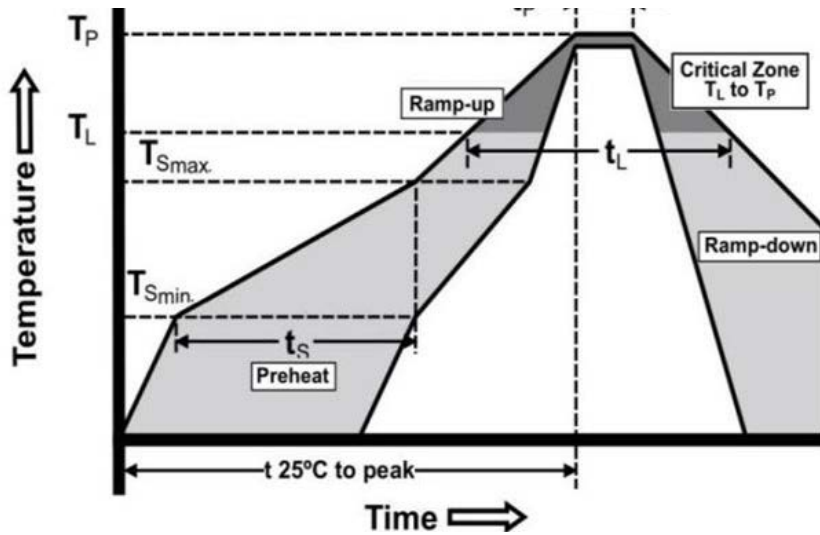

Profile feature	Lead (Pb) free solder	
Preheat and soak	<ul style="list-style-type: none"> • Temperature min. (T_{Smin}) • Temperature max. (T_{Smax}) • Time (T_{Smin} to T_{Smax}) (t_S) 	150 °C 200 °C 60-120 seconds
Ramp up rate T_{Smax} to T_P	3 °C/ second max.	
Melting tin time (t_L)	20 s - 30 s	
Peak package body temperature (T_P)*	260 °C	
Time (t_p)* within 5 °C of the specified classification temperature (T_C)	5 seconds	
Ramp-down rate (T_P to T_L)	6 °C/ second max.	
Time 25 °C to peak temperature	8 minutes max.	

Manual solder

+350 °C ±10 °C , 5 seconds maximum (by soldering iron), generally manual, hand soldering is not recommended

Eaton
Electronics Division
 1000 Eaton Boulevard
 Cleveland, OH 44122
 United States
Eaton.com/electronics

Life Support Policy: Eaton does not authorize the use of any of its products for use in life support devices or systems without the express written approval of an officer of the Company. Life support systems are devices which support or sustain life, and whose failure to perform, when properly used in accordance with instructions for use provided in the labeling, can be reasonably expected to result in significant injury to the user.

Eaton reserves the right, without notice, to change design or construction of any products and to discontinue or limit distribution of any products. Eaton also reserves the right to change or update, without notice, any technical information contained in this bulletin.

Alcom electronics
ASTELIAU TECHNOLOGY COMPANY

Singel 3 | B-2550 Kontich | Belgium | Tel.+32(0)3 458 30 33
info@alcom.be | www.alcom.be
 Rivium 1e straat 52 | 2909 LE Capelle aan den IJssel | The Netherlands
 Tel.+31(0)10 288 25 00 | info@alcom.nl | www.alcom.nl