

Digi XBee XR 868

The Digi XBee XR family operates in the 863-870 MHz range, delivering superior performance and interference immunity

The **Digi XBee® XR 868** module is a compact and reliable solution supporting deployment of long-range connectivity applications in the European region. The pre-certified module operates between 863 and 870 MHz in compliance with European standards.

The module enables both point-to-point and mesh networking protocols, with a line-of-sight range of over 14 kilometers, and compatibility with the SX protocol. It is available with multiple form factors and antenna options, and is well suited for agriculture and energy applications where long-distance communication is required.

Intelligent interference management

Digi XBee XR 868 also leverages 868 MHz and surrounding frequencies for LBT + AFA (Listen Before Talk and Adaptive Frequency Agility). This significantly reduces interference by listening to the radio environment before any transmission starts, and automatically shifts to a new channel when interference is detected. This patented frequency scan occurs automatically and in a matter of microseconds so as not to impact performance.

Accelerate development with Digi XBee Studio

The Digi XBee XR 868 RF module is a complete hardware and software solution that works directly out of the box. **Digi XBee Studio** enables developers to manage Digi XBee devices through a simple-to-use graphical interface, ensuring your product gets to market fast.

Key features, benefits and applications

- Low-power CE/RED certified 868 MHz RF module based on Silicon Labs EFR32 microcontroller
- Design includes SAW filter for optimal performance in noisy RF environments
- Listen-Before-Talk and Frequency Agility for optimal interference immunity
- **DigiMesh®** networking topology for redundancy and reliability
- Simple configuration using **Digi XBee Studio** accelerates time to market

Application example

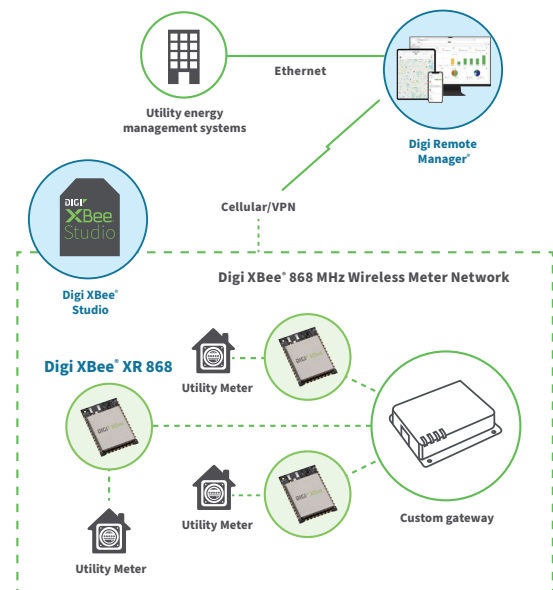

Need custom gateway engineering support?
Contact Digi Wireless Design Services.

Related Digi devices





Manage and configure Digi XBee XR 868 modules with Digi XBee Studio

| Specifications | Digi XBee XR 868 |
|-------------------------------|---|
| HARDWARE | |
| PROCESSOR | EFR32FG13P231F512 transceiver at 40 MHz |
| FREQUENCY BAND | 863 MHz – 870 MHz |
| AVAILABLE FORM FACTORS | Micro-mount (MMT), surface-mount (SMT), through-hole (TH) |
| ANTENNA OPTIONS | MMT: U.FL connector, RF pad SMT: U.FL connector, RF pad, chip antenna TH: U.FL connector, SMA |
| DIMENSIONS | MMT: 13 x 19 x 2 mm (0.533 x 0.76 x 0.087 in) SMT: 2.199 x 3.4 x 0.305 cm (0.866 x 1.33 x 0.120 in) TH: 2.438 x 2.761 cm (0.960 x 1.087 in) |
| WEIGHT | MMT: 1.2 g (0.042 oz) SMT: 3.0 g (0.106 oz) TH: 3.1 g (0.109 oz) |
| PERFORMANCE | |
| RF DATA RATE | 10 kbps or 80 kbps, software selectable |
| UART DATA RATE | Up to 921.6 kbps |
| SPI DATA RATE | Up to 5 Mbps |
| LINE-OF-SIGHT RANGE* | Up to 14.5 km with 2.1 dBi antenna |
| TRANSMIT POWER | Up to 13 dBm ERP |
| RECEIVER SENSITIVITY | -107 dBm at 80 Kbps, -112 dBm at 10 Kbps |
| FEATURES | |
| I/O | 13 digital I/O |
| ANALOG INPUTS | 4 channels 10-bit |
| OPERATING TEMPERATURE | -40 °C to 85 °C (-40 °F to 185 °F), temperature compensated crystal oscillator |
| NETWORKING TOPOLOGIES | DigiMesh, repeater; SX protocol compatible |
| SECURITY | 256-bit AES encryption |
| POWER | |
| SUPPLY VOLTAGE | 2.1 – 3.6 VDC |
| TRANSMIT CURRENT | 76 mA |
| RECEIVE CURRENT | 26 mA |
| SLEEP CURRENT | 1.5 µA |
| REGULATORY APPROVALS** | |
| ETSI (EUROPE) | CE/RED |
| ROHS | Yes |

*Range figure estimates are based on free-air terrain with limited sources of interference. Actual range will vary based on transmitting power, orientation of transmitter and receiver, height of transmitting antenna, height of receiving antenna, weather conditions, interference sources in the area, and terrain between receiver and transmitter, including indoor and outdoor structures such as walls, trees, buildings, hills, and mountains.

**Visit digi.com/resources/certifications for latest updates.

Management and Configuration

Digi XBee Studio

Free multi-platform application that enables developers to manage Digi XBee devices through a simple-to-use graphical interface

Digi XBee Studio is the definitive tool to manage and configure Digi XBee devices. This next generation configuration tool suite supersedes **Digi XCTU** and offers an advanced set of tools that make it easy to set up, configure, communicate with and test Digi XBee modules and devices.

The first thing you need to do in order to work with XBee devices in XBee Studio is to add them to the tool. In XBee Studio, this is easier than ever.

Simple setup and connectivity

Just after startup, XBee Studio will automatically look for XBee devices connected to your computer. As modules are found, they will appear in the Device Browser view. The Device Browser view displays all the devices connected to your computer.

View and manage your Digi XBee devices

View all of your Digi XBee devices in one table, or if they are geo-located, you can switch to the map view and see the location of each one.

Digi XBee Studio also offers a simple and step-by-step way to access and manage devices, including additional options for configuration, diagnostics, development, remote management and other utilities.

Proven experience and expert support

Our decades of embedded experience and millions of deployed devices tell our story; Digi is a trusted solutions provider dedicated to simplifying the way OEMs design, build, deploy and maintain secure connected products.

Digi Wireless Design Services (WDS) is an engineering team that provides additional connectivity integration support, certification assistance, and custom design and build services to get your products to market smarter and faster. The expert team of WDS engineers can support you wherever you are along your development path.



Key features

- **Deploy on multiple platforms:** Digi XBee Studio is compatible with the most popular operating systems, including Microsoft Windows, macOS and Linux.
- **Discover your devices:** Automatically discover XBee devices connected to your computer, regardless of their port connections or configured settings.
- **Configure any device:** Manage and configure multiple XBee devices at once, including devices enrolled in your Digi Remote Manager account located anywhere in the world.
- **Communicate with your devices:** Use the new smart XBee console to communicate with your devices regardless of whether they are configured for API mode or transparent mode..
- **Access a range of tools:** Use embedded tools to perform operations like creating XBee profiles or recovering your devices.
- **Get automatic updates:** Automatically update the application itself, as well as the radio firmware library, without downloading any extra files.

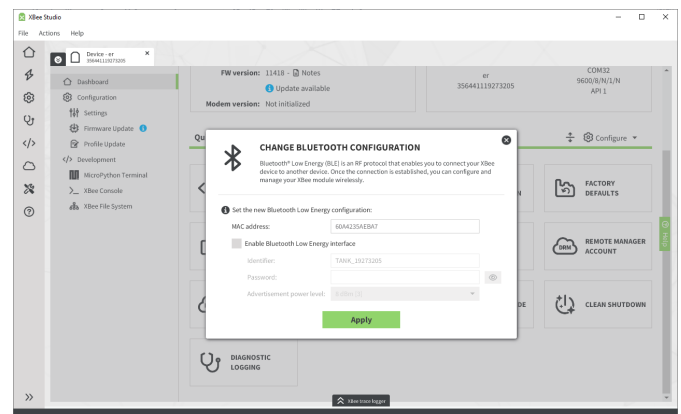

DIGI XBEE XR 868

Digi XBee Ecosystem, Tools and Supporting Services

Digi XBee Ecosystem

The world-renowned XBee module is part of a family of cellular modems and RF modules that provide ultimate flexibility for IoT application developers, with three programmable form factors, and a range of popular wireless protocols. The XBee family also includes IoT gateways and management tools to connect, monitor and manage your XBee network. [Learn more at digi.com/xbee](http://digi.com/xbee).

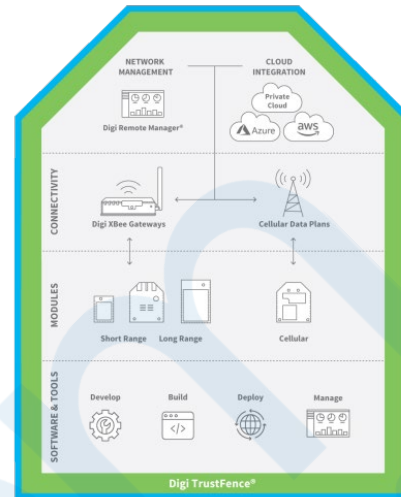

Digi XBee Tools

The **Digi XBee Ecosystem** is fully supported with the award-winning **Digi XBee Tools** suite. Designed to support the full product lifecycle, from prototyping and development to deployment and ongoing monitoring, Digi XBee Tools includes code libraries, testing and prototyping tools, product development and manufacturing support, and tools for deploying and managing end devices in the field.



DEVELOP



BUILD



DEPLOY



MANAGE

Digi Wireless Design Services



DEFINITION



DEVELOPMENT



CERTIFICATION



MANUFACTURING

Digi WDS Services

We offer services to support you wherever you are along your development path, with a record that speaks for itself.

- Proof of concept
- Architecture consultation
- Requirements definition
- System, software and electrical design
- Design reviews
- Certifications
- Prototype build
- Manufacturing test fixtures
- 250+ product development projects
- 100+ certification failure rescues
- 100 million connected devices around the globe

Get to market faster with Digi WDS

Digi Wireless Design Services (WDS) has a proven history of helping clients speed down the path to success by guiding them through the technological and regulatory certification pitfalls that botch budgets and disrupt product introductions.

We begin by actively listening to your business and technical requirements, and then leverage our proven methodology, world-class engineering expertise and library of IP to design a cost-effective solution that is tailored to your specific needs. Accelerate toward the solution that is right for you and your customers.

Contact **Digi WDS** to find out how we can guide you to success.

DIGI XBEE XR 868

Photos

Digi XBee XR 868 photos and dimensions

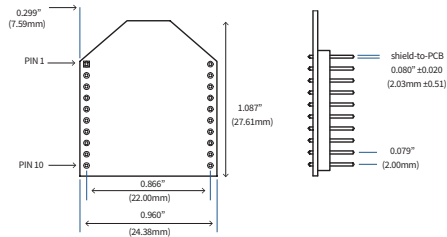
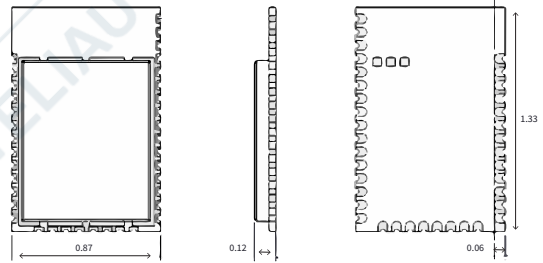
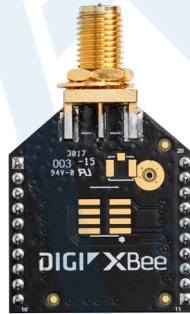
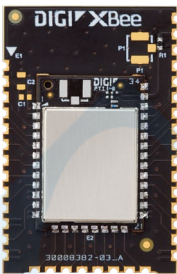
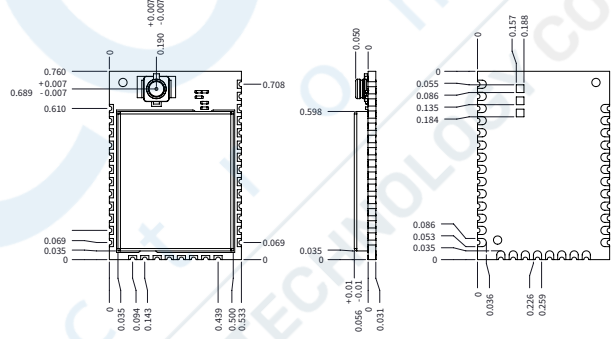
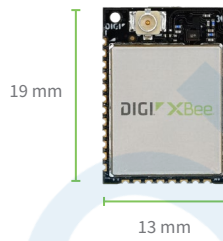

DIGI XBEE XR 868

Part Numbers

| Part Numbers | Digi XBee XR 868 |
|---|--|
| DIGI XBEE XR 868 MICRO-MOUNT (MMT) | |
| XB-8XR-DMUM-101 | Digi XBee XR 868 MHz, DigiMesh, U.FL, MMT |
| XB-8XR-DMRM-101 | Digi XBee XR 868 MHz, DigiMesh, RF pad, MMT |
| DIGI XBEE XR 868 SURFACE-MOUNT (SMT) | |
| XB-8XR-DMCS-101 | Digi XBee XR 868 MHz, DigiMesh, chip, SMT |
| XB-8XR-DMRS-101 | Digi XBee XR 868 MHz, DigiMesh, RF pad, SMT |
| XB-8XR-DMUS-101 | Digi XBee XR 868 MHz, DigiMesh, U.FL, SMT |
| DIGI XBEE XR 868 THROUGH-HOLE (TH) | |
| XB-8XR-DMUT-101 | Digi XBee XR 868 MHz, DigiMesh, U.FL, TH |
| XB-8XR-DMST-101 | Digi XBee XR 868 MHz, DigiMesh, SMA, TH |
| DIGI XBEE XR 868 MICRO-MOUNT (MMT) — NRND | |
| XB-8XR-DMUM-001 | Digi XBee XR 868 MHz, DigiMesh, U.FL, MMT (not recommended for new designs, see XB-8XR-DMUM-101) |
| XB-8XR-DMRM-001 | Digi XBee XR 868 MHz, DigiMesh, RF pad, MMT (not recommended for new designs, see XB-8XR-DMRM-101) |

| Part Numbers | Digi XBee XR 868 Development Kit |
|----------------------------------|---|
| DIGI XBEE XR 868 DEVELOPMENT KIT | |
| XK-8XR-DMM | Digi XBee XR 868 Development Kit with Digi XBee XR 868 MHz, U.FL, MMT |

