

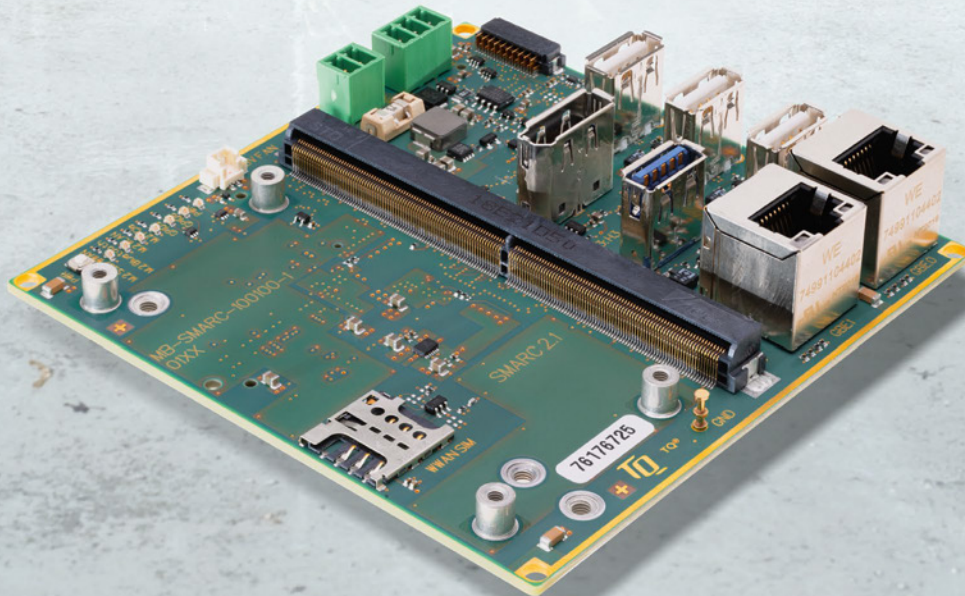

MB-SMARC-100100-1 User's Manual

MB-SMARC-100100-1 UM 0001
30.05.2022



Singel 3 | B-2550 Kontich | Belgium | Tel.+32(0)3 458 30 33
info@alcom.be | www.alcom.be
Rivium 1e straat 52 | 2909 LE Capelle aan den IJssel | The Netherlands
Tel.+31(0)10 288 25 00 | info@alcom.nl | www.alcom.nl



TABLE OF CONTENTS

1.	ABOUT THIS MANUAL.....	1
1.1	Copyright and Licence Expenses	1
1.2	Registered Trademarks	1
1.3	Disclaimer	1
1.4	Imprint.....	1
1.5	Service and Support.....	1
1.6	Tips on Safety.....	2
1.7	Symbols and Typographic Conventions.....	2
1.8	Handling and ESD Tips	2
1.9	Naming of Signals	3
1.10	Further Applicable Documents / Presumed Knowledge.....	3
2.	INTRODUCTION.....	4
2.1	Functional Overview	4
2.2	Specification Compliance	4
2.3	Carrier Board Standard Configurations.....	4
3.	ELECTRONICS.....	5
3.1	Block Diagram	5
3.2	Power Supply.....	6
3.2.1	Supply Voltage Characteristics.....	6
3.2.2	Power Consumption Specification	6
3.3	Environmental Specification.....	6
3.4	Connectors and Interfaces.....	7
3.4.1	Power Supply.....	9
3.4.2	DisplayPort	9
3.4.3	USB Interfaces.....	9
3.4.4	Gigabit Ethernet	10
3.4.5	Serial Interfaces (RS-485).....	10
3.4.6	M.2 E-Key and M-Key sockets	11
3.4.6.1	M.2 Socket with E-Key	11
3.4.6.2	M.2 Socket with M-Key	11
3.4.7	M.2 Socket with B-Key	11
3.4.8	Feature connector.....	12
3.4.9	Fan Connector.....	12
3.4.10	Debug LEDs.....	12
4.	MECHANICS.....	13
4.1	Dimensions.....	13
4.2	Protection against External Effects.....	13
4.3	Labeling	13
5.	SOFTWARE	14
5.1	System Resources.....	14
5.1.1	General Purpose I ² C Bus	14
5.1.2	SMBus / Power Management I ² C Bus.....	14
5.2	Operating Systems	14
5.2.1	Supported Operating Systems.....	14
5.2.2	Driver Download	14
6.	SAFETY REQUIREMENTS AND PROTECTIVE REGULATIONS	15
6.1	EMC	15
6.2	ESD.....	15
6.3	Shock & Vibration.....	15
6.4	Operational Safety and Personal Security.....	15
6.5	Environment protection	15
6.5.1	RoHS.....	15
7.	ENVIRONMENT PROTECTION	16
7.1	RoHS	16
7.2	WEEE®	16
7.3	REACH®	16
7.4	EuP.....	16
7.5	Battery.....	16
7.6	Packaging.....	16
7.7	Other Entries	16
8.	APPENDIX.....	17



8.1 Acronyms and Definitions 17
8.2 References 19



TABLE DIRECTORY

Table 1:	Terms and Conventions.....	2
Table 2:	Pinout Power-In connector	9
Table 3:	Function of Ethernet LEDs.....	10
Table 4:	RS-485 Phoenix connector	10
Table 5:	Feature connector (X14).....	12
Table 6:	5 V Fan Connector	12
Table 7:	Debug LEDs.....	12
Table 8:	Labels	13
Table 9:	Acronyms	17
Table 10:	Further Applicable Documents and Links	19

FIGURE DIRECTORY

Figure 1:	Block diagram MB-SMARC-100100-1.....	5
Figure 2:	MB-SMARC-100100-1, Top	7
Figure 3:	MB-SMARC-100100-1, Bottom.....	8
Figure 4:	Position of labels	13



REVISION HISTORY

Rev.	Date	Name	Pos.	Modification
0100	30.05.2022	PD		First edition



1. ABOUT THIS MANUAL

1.1 Copyright and Licence Expenses

Copyright protected © 2022 by TQ-Systems GmbH.

This User's Manual may not be copied, reproduced, translated, changed or distributed, completely or partially in electronic, machine readable, or in any other form without the written consent of TQ-Systems GmbH.

The drivers and utilities for the components used as well as the BIOS are subject to the copyrights of the respective manufacturers. The licence conditions of the respective manufacturer are to be adhered to.

BIOS-licence expenses are paid by TQ-Systems GmbH and are included in the price.

Licence expenses for the operating system and applications are not taken into consideration and must be calculated / declared separately.

1.2 Registered Trademarks

TQ-Systems GmbH aims to adhere to copyrights of all graphics and texts used in all publications, and strives to use original or license-free graphics and texts.

All brand names and trademarks mentioned in this User's Manual, including those protected by a third party, unless specified otherwise in writing, are subjected to the specifications of the current copyright laws and the proprietary laws of the present registered proprietor without any limitation. One should conclude that brand and trademarks are rightly protected by a third party.

1.3 Disclaimer

TQ-Systems GmbH does not guarantee that the information in this User's Manual is up-to-date, correct, complete or of good quality. Nor does TQ-Systems GmbH assume guarantee for further usage of the information. Liability claims against TQ-Systems GmbH, referring to material or non-material related damages caused, due to usage or non-usage of the information given in this User's Manual, or due to usage of erroneous or incomplete information, are exempted, as long as there is no proven intentional or negligent fault of TQ-Systems GmbH.

TQ-Systems GmbH explicitly reserves the rights to change or add to the contents of this User's Manual or parts of it without special notification.

1.4 Imprint

TQ-Systems GmbH
Gut Delling, Mühlstraße 2
D-82229 Seefeld

Tel: +49 (0) 8153 9308-0

Fax: +49 (0) 8153 9308-4223

E-Mail: Info@TQ-Group

Web: TQ-Group

1.5 Service and Support

Please visit our website TQ-Group for latest product documentation, drivers, utilities and technical support.

You can register on our website TQ-Group to have access to restricted information and automatic update services.

For direct technical support you can contact our FAE team by email: TQ-Support.

Our FAE team can also support you with additional information like 3D-STEP files and confidential information, which is not provided on our public website.





For service or RMA, please contact our service team by email (TQ-Service) or your sales team at TQ.

1.6 Tips on Safety

Improper or incorrect handling of the product can substantially reduce its life span.

1.7 Symbols and Typographic Conventions

Table 1: Terms and Conventions

Symbol	Meaning
	This symbol represents the handling of electrostatic-sensitive modules and / or components. These components are often damaged / destroyed by the transmission of a voltage higher than about 50 V. A human body usually only experiences electrostatic discharges above approximately 3,000 V.
	This symbol indicates the possible use of voltages higher than 24 V. Please note the relevant statutory regulations in this regard. Non-compliance with these regulations can lead to serious damage to your health and also cause damage / destruction of the component.
	This symbol indicates a possible source of danger. Acting against the procedure described can lead to possible damage to your health and / or cause damage / destruction of the material used.
	This symbol represents important details or aspects for working with TQ-products.
Command	A font with fixed-width is used to denote commands, contents, file names, or menu items.

1.8 Handling and ESD Tips

General handling of your TQ-products

	<p>The TQ-product may only be used and serviced by certified personnel who have taken note of the information, the safety regulations in this document and all related rules and regulations.</p> <p>A general rule is: do not touch the TQ-product during operation. This is especially important when switching on, changing jumper settings or connecting other devices without ensuring beforehand that the power supply of the system has been switched off.</p> <p>Violation of this guideline may result in damage / destruction of the MB-SMARC-100100-1 and be dangerous to your health.</p> <p>Improper handling of your TQ-product would render the guarantee invalid.</p>
---	---

Proper ESD handling

	<p>The electronic components of your TQ-product are sensitive to electrostatic discharge (ESD).</p> <p>Always wear antistatic clothing, use ESD-safe tools, packing materials etc., and operate your TQ-product in an ESD-safe environment. Especially when you switch modules on, change jumper settings, or connect other devices.</p>
---	--



1.9 Naming of Signals

A hash mark (#) at the end of the signal name indicates a low-active signal.

Example: RESET#

If a signal can switch between two functions and if this is noted in the name of the signal, the low-active function is marked with a hash mark and shown at the end.

Example: C / D#

If a signal has multiple functions, the individual functions are separated by slashes when they are important for the wiring. The identification of the individual functions follows the above conventions.

Example: WE2# / OE#

1.10 Further Applicable Documents / Presumed Knowledge

- **Specifications and manual of the product used:**
These documents describe the service, functionality and special characteristics of the product used.
- **Specifications of the components used:**
The manufacturer's specifications of the components used, for example CompactFlash cards, are to be taken note of. They contain, if applicable, additional information that must be taken note of for safe and reliable operation. These documents are stored at TQ-Systems GmbH.
- **Chip errata:**
It is the user's responsibility to make sure all errata published by the manufacturer of each component are taken note of. The manufacturer's advice should be followed.
- **Software behaviour:**
No warranty can be given, nor responsibility taken for any unexpected software behaviour due to deficient components.
- **General expertise:**
Expertise in electrical engineering / computer engineering is required for the installation and the use of the device.



2. INTRODUCTION

The SMARC mainboard MB-SMARC-100100-1 is a carrier board for SMARC modules with a pinout based on the SMARC 2.1 specification.

It can be used as a demonstrator for mini PCs, IoT or image processing.

In combination with a standard SMARC module it forms a very compact hardware kit that can be used for a freely scalable embedded PC platform thanks to its modular design. This means that the PC system - with uniform interfaces and dimensions - can be easily adapted to the requirements of the application. The many expansion options and storage media that can be added provide a high degree of flexibility and allow functionalities and performance to be scaled easily, quickly and cost-effectively.

2.1 Functional Overview

The following key functions are implemented on the MB-SMARC-100100-1:

Supported modules:

- SMARC modules with pinout based on SMARC 2.1 specification

External Interfaces:

- 2 × Gigabit Ethernet
- 4 × USB (1x Type A with up to 5Gb/s, 3x Type A with 480Mb/s)
- 1 × DisplayPort (DP++)
- 1 × RS485
- Power Button

Internal Interfaces:

- M.2 socket B-Key 2242/3042 or 2252/3052 with USB 2.0, USB 3.0 and SATA (for SATA SSDs or WWAN modules, with micro SIM Card support)
- Either/or assembly option
 - M.2 socket E-Key 2230 with PCIe x1 and USB 2.0 (e.g. for WLAN cards)
+ M.2 socket M-Key 2230 with PCIe x2 (e.g. for ultra-compact PCIe x2 NVME SSDs)
 - M.2 socket M-Key 2280 with PCIe x4 (for NVMe SSDs, PCIe based accelerator cards or PCIe x4 adapters)
- Feature connector (GP-I2C, PM-I2C (SMB), SER TX / RX, GPIO) to extend functionality e.g. with IoT sensors and GPIO

Power supply:

- Voltage: 12 V DC ±5 %

Environment:

- Extended temperature: -20 °C to +85 °C

Form factor / dimensions:

- 100 mm × 100 mm

2.2 Specification Compliance

The MB-SMARC-100100-1 supports SMARC modules, which are compliant to SGET SMARC Hardware Specification (V2.1).

2.3 Carrier Board Standard Configurations

- **MB-SMARC-100100-1-TYPA**
4x PCIe @ M.2 M-Key socket, M.2 E-Key socket not populated
- **MB-SMARC-100100-1-TYPB**
2x PCIe @ M.2 M-Key socket, M.2 E-Key socket populated

Other configurations are available on request.

3. ELECTRONICS

3.1 Block Diagram

The following illustration shows the block diagram of the MB-SMARC-100100-1:

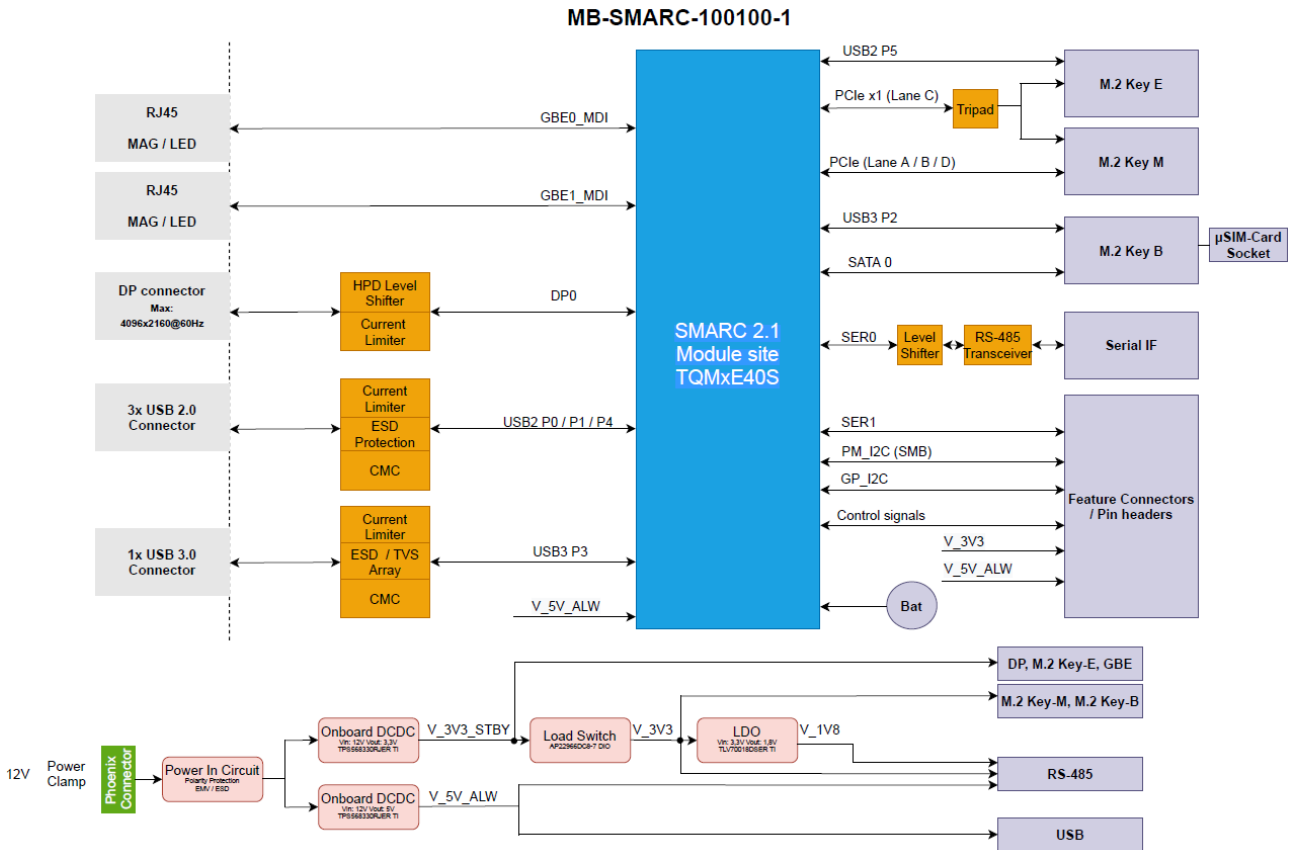

Figure 1: Block diagram MB-SMARC-100100-1

3.2 Power Supply

3.2.1 Supply Voltage Characteristics

The MB-SMARC-100100-1 requires an input voltage of 12 V DC $\pm 5\%$.

The input voltages shall rise from 10 % of nominal to 90 % of nominal within 0.1 ms to 20 ms.
(0.1 ms \leq Rise Time \leq 20 ms).

There must be a smooth and continuous increase of each DC output voltage from 10 % to 90 % of its final set point within the regulation range.

3.2.2 Power Consumption Specification

The power consumption of the system significantly depends on the connected devices (SMARC module, mass storage devices, WWAN modules, USB devices etc.).

The power consumption of the MB-SMARC-100100-1 itself is approximately 1 W (SMARC module supplied externally; Windows 10 active; Keyboard, mouse, mass storage device connected).

The maximum input current of the MB-SMARC-100100-1 is limited to 5 A by a fuse.

Note: Power requirement



The power supply for the MB-SMARC-100100-1 must be configured with enough power reserve. It should be calculated with the maximum power of all connected components.

3.3 Environmental Specification

- Operating temperature, extended: $-20\text{ }^{\circ}\text{C}$ to $+85\text{ }^{\circ}\text{C}$
- Storage temperature: $-20\text{ }^{\circ}\text{C}$ to $+85\text{ }^{\circ}\text{C}$
- Relative humidity (operating / storage): 10 % to 90 % (not condensing)

3.4 Connectors and Interfaces

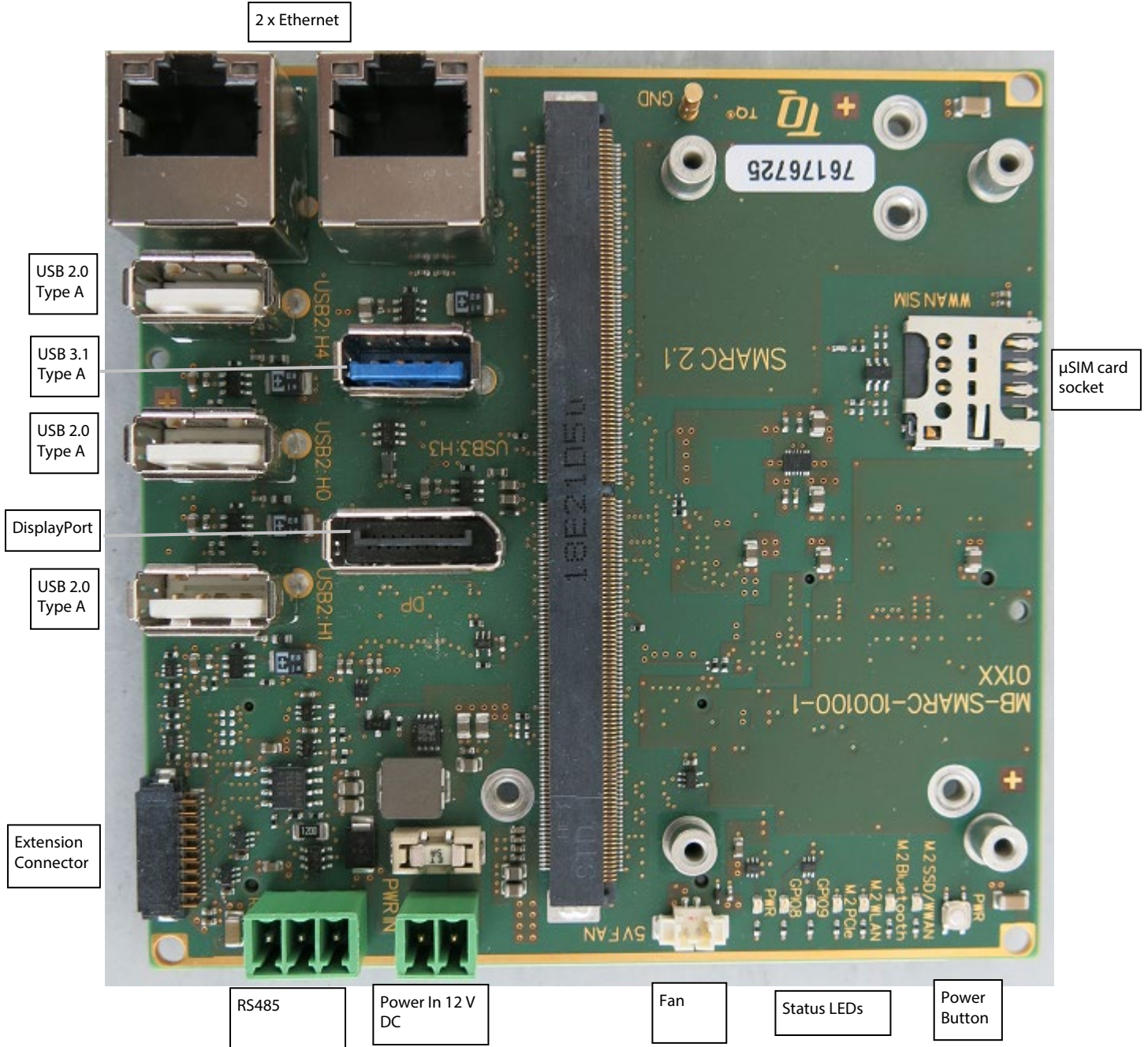

Figure 2: MB-SMARC-100100-1, Top

Connectors and Interfaces (continued)

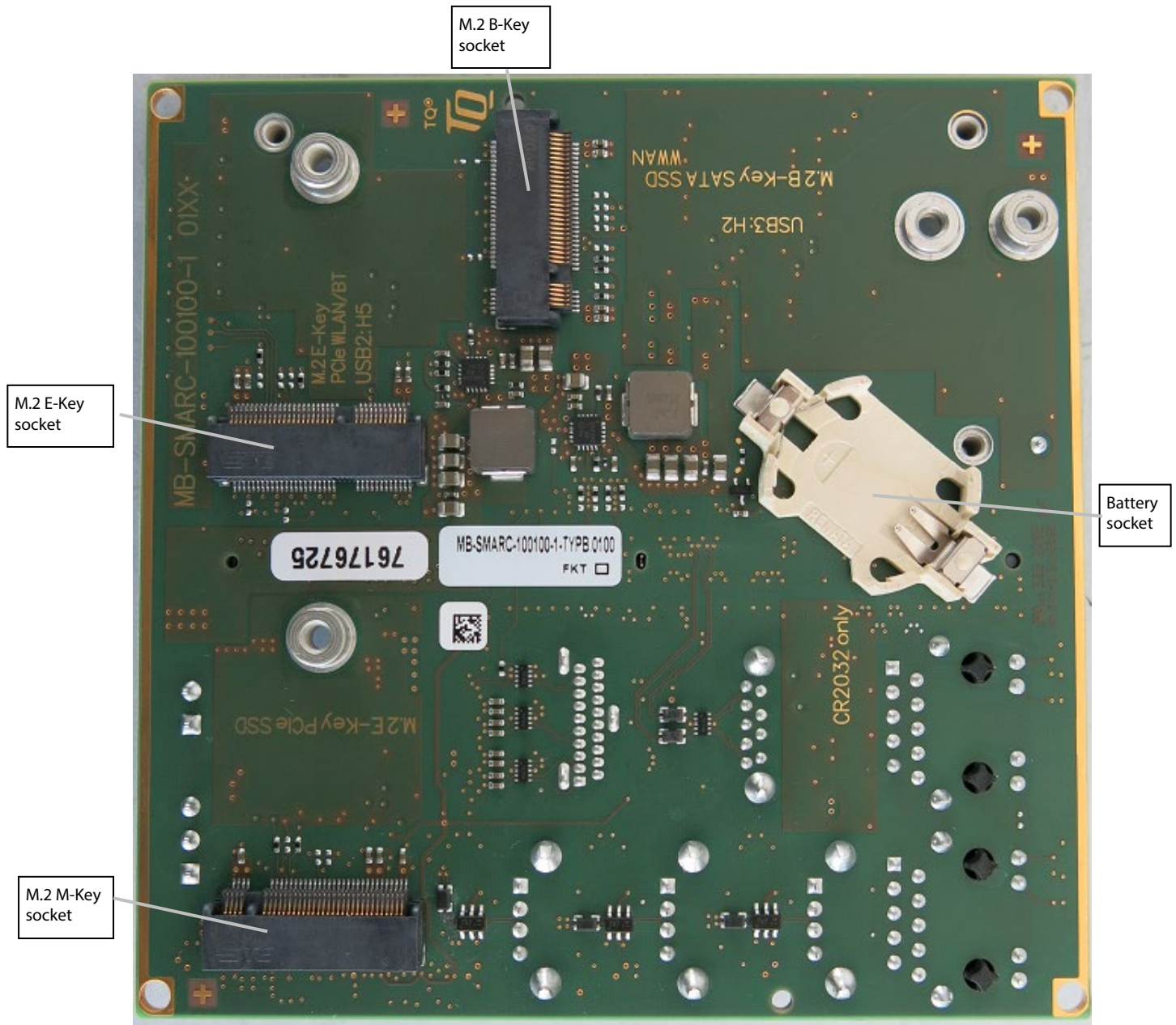

Figure 3: MB-SMARC-100100-1, Bottom



3.4.1 Power Supply

The MB-SMARC-100100-1 requires a single 12 V DC power supply. The voltage should not vary more than $\pm 5\%$.

Power-In connector X3:

- Connector type: Phoenix MCV 1,5/ 2-G-3,5-AU
- Mating connector: e.g. Phoenix FMC 1,5/ 2-STF-3,5

Table 2: Pinout Power-In connector

Pin	Signal	Remark
1	GND	
1	12 V	Fused @ 5 A

3.4.2 DisplayPort

The MB-SMARC-100100-1 provides one DisplayPort interface.

The support of the interface and adapters from DP to HDMI, DVI or VGA depends on the combination of the SMARC module and the adapter used. The combination of some modules with some adapters might not work.

3.4.3 USB Interfaces

The MB-SMARC-100100-1 provides several USB Host interfaces.

X6: A-Type connector (USB3.1 Gen1, 5 GB/s) for direct usage of USB host port

X7, X8, X9: A-Type connector (USB2.0) for direct usage of USB host port

3.4.4 Gigabit Ethernet

The MB-SMARC-100100-1 provides two common 10/100/1000 Mbps speed Gigabit Ethernet ports. For both ports the Ethernet signals of the SMARC module are used.

Table 3: Function of Ethernet LEDs

LED Colour	Function
Green	Link is up (Link is connected)
Orange / Yellow	Act (Blinks at data transfer)

3.4.5 Serial Interfaces (RS-485)

The MB-SMARC-100100-1 provides up to two serial ports:

- RS-485 port at on-board connector X4
- SER1 RX / TX at feature connector X14

RS-485 connector: For usage of the RS-485 port

- Connector type: Phoenix MCV 1,5/ 3-G-3,5
- Mating connector: Phoenix FMC 1,5/3-ST-3,5

The RS-485 interface does not support galvanic isolation.

Table 4: RS-485 Phoenix connector

Pin	RS-485 Signal	MB-SMARC-100100-1
1	A	RS485_A
2	B	RS485_B
3	GND	GND

A 120 Ohm termination resistor is assembled by default.

Please contact [TQ-Support](#) for further information about detailed information about available serial ports.



3.4.6 M.2 E-Key and M-Key sockets

For M.2 E-Key and M.2 M-Key the MB-SMARC-100100-1 provides different configurations:

Assembly option 1:

- M.2 socket E-Key 2230 with PCIe x1 and USB2.0 (e.g. for WLAN cards)
+ M.2 socket M-Key 2230 with PCIe x2 (e.g. for ultra-compact PCIe x2 NVME SSDs)

Assembly option 2:

- M.2 socket M-Key 2280 with PCIe x4 (for NVMe SSDs, PCIe based accelerator cards or PCIe x4 adapters)

3.4.6.1 M.2 Socket with E-Key

The MB-SMARC-100100-1 provides a socket to support an M.2 add-in card with 22 mm width and 30 mm length. USB and a PCIe x1 interface signals are routed to this socket. The M.2 socket with E-Key cannot be populated if M.2 M-Key devices with 80 mm length are used (refer to section [M.2 Socket with M-Key](#)).

M.2 2230 single and double sided add-in cards with E or A+E-Keying can be inserted.

The maximum transfer rate of this interface mainly depends on the SMARC module used and the connected device.

3.4.6.2 M.2 Socket with M-Key

The MB-SMARC-100100-1 provides a socket to support PCIe based M.2 add-in cards with 22 mm width and 80 mm or 30 mm length.

PCIe x4 or PCIe x2 interface signals are routed to this socket (depends on the configuration).

One lane is multiplexed with the M.2 E-Key Socket. If the M.2 E-Key Socket is populated, only PCIe x2 interface signals are routed to the M.2 M-Key socket and only cards with 22 mm width and 30 mm length can be supported on the M.2 M-Key socket.

M.2 2280 or 2230 single and double sided add-in cards with M or B+M-Keying can be inserted.

The reachable transfer rate of this interface mainly depends on the SMARC module and the connected device.

3.4.7 M.2 Socket with B-Key

The MB-SMARC-100100-1 provides a socket to support SATA based M.2 SSDs or USB based WWAN add-in cards.

SATA and USB 3.1 interface signals are routed to this socket. A Micro SIM card socket for native support of NR or LTE add-in cards is also available.

M.2 3042, 3052 or 2242 single and double sided add-in cards with B or B+M-Keying can be inserted. Add-in cards with 42 mm length have to be mounted with an additional distance spacer.

The component height at bottom side of the add-in card with 52 mm length shall not exceed 1.35 mm. Prevent contact between the add-in card and the steel spacer for mounting add-in cards with 42 mm length.

The reachable transfer rate of this interface depends mainly on the SMARC module used and the connected device.

3.4.8 Feature connector

The MB-SMARC-100100-1 provides a Board-to-Board connector with GP-I2C, PM-I2C (SMB) and SER1 TX / RX Interface as well as GPIO pins, SMARC specific control signals and 3.3V / 5V power.

Maximum current per power pin:

- Pin 2: V_3V3, max 100 mA
- Pin 18: V_3V3_STBY, max 500 mA
- Pin 19: V_5V_ALW, max 100 mA

Feature connector X14:

- Connector type: SAMTEC SFMH-110-02-L-D-WT-TR (1.27 mm pitch)
- Mating connector: SAMTEC FSH / FTSH

Table 5: Feature connector (X14)

Signal	Pin		Signal
GND	1	2	V_3V3 (max. 100 mA)
SER1_TX_3V3	3	4	GND
PCIE_WAKE_3V3#	5	6	SER1_RX_3V3
GPIO8_1V8	7	8	BATLOW_1V8#
GPIO9_1V8	9	10	SYS_RST_1V8#
I2C_GP_CK_3V3	11	12	PWR_BTN_1V8#
SMB_CLK_3V3	13	14	I2C_GP_DAT_3V3
SMB_DAT_3V3	15	16	SMB_ALERT_3V3#
GND	17	18	V_3V3_STBY (max. 500 mA)
V_5V_ALW (max. 100 mA)	19	20	GND

3.4.9 Fan Connector

The MB-SMARC-100100-1 provides a connector for 5 V fans with a 2-pin connector.

5 V fan connector X2

- Connector type: Molex 53398-0271

Table 6: 5 V Fan Connector

Pin	Signal	Remark
1	GND	-
2	V_5V_ALW	5V fan power (no PWM signal)

3.4.10 Debug LEDs

The MB-SMARC-100100-1 provides several LEDs for debug purposes.

Table 7: Debug LEDs

Function	PCB Text	Remark
Power	PWR	Green if input power is present
GPIO 8	GPIO 8	Green if GPIO 8 is active
GPIO 9	GPIO 9	Green if GPIO 9 is active
M.2 B-Key socket status	M.2 SSD/WWAN	Depends on M.2 B-Key card
M.2 E-Key socket WLAN status	M.2 WLAN	Depends on M.2 E-Key card
M.2 E-Key socket Bluetooth status	M.2 Bluetooth	Depends on M.2 E-Key card
M.2 M-Key socket status	M.2 PCIe	Depends on M.2 M-Key card

4. MECHANICS

4.1 Dimensions

The dimensions are 100 mm × 100 mm.

Please contact [TQ-Support](#) for more details about 3D Step models.

4.2 Protection against External Effects

The MB-SMARC-100100-1 is not protected against dust, external impact and contact (IP00). Adequate protection has to be guaranteed by the surrounding system.

4.3 Labeling

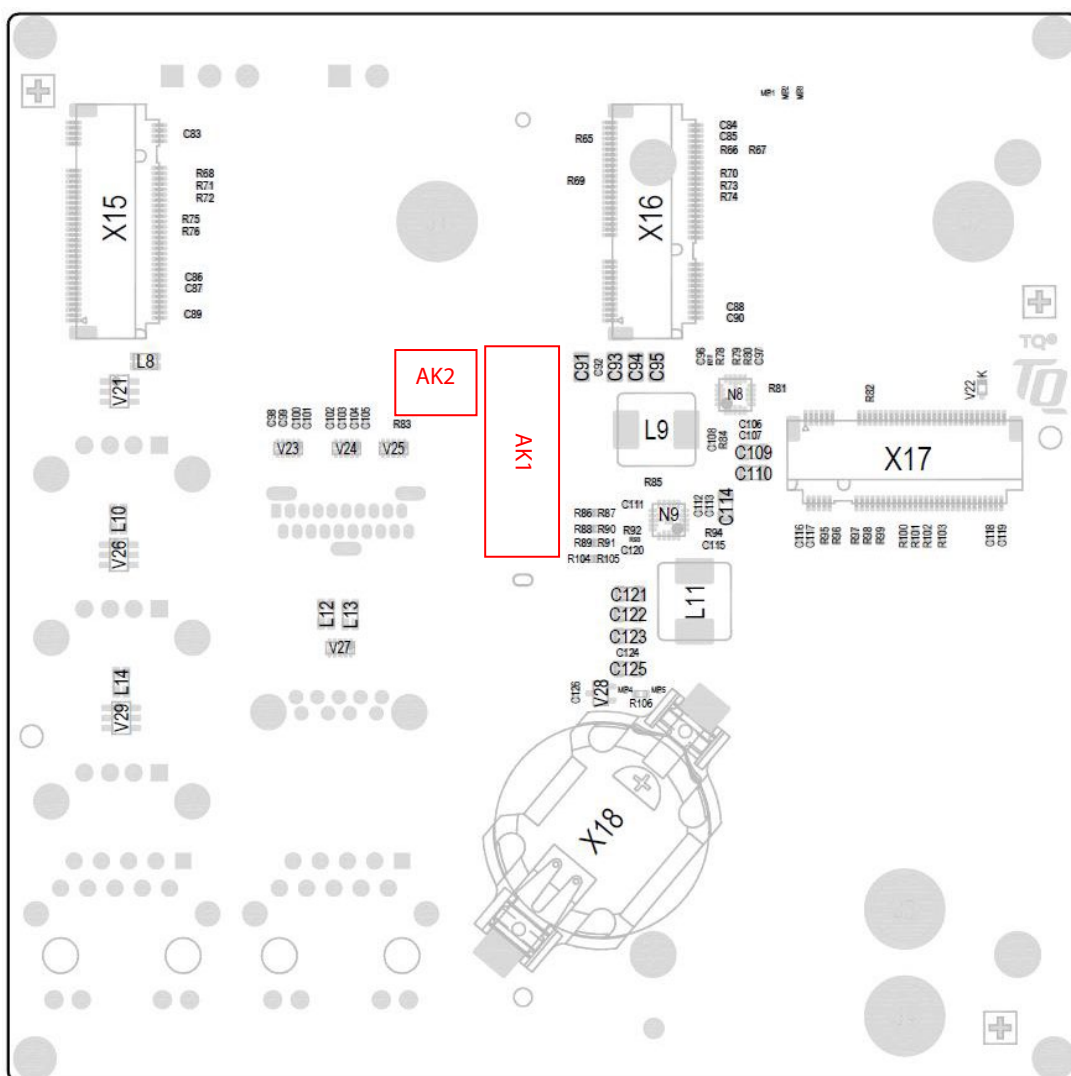

Figure 4: Position of labels

Table 8: Labels

Label	Type
AK1	Article name and test run
AK2	TQ Serial number



5. SOFTWARE

5.1 System Resources

5.1.1 General Purpose I²C Bus

The general purpose I²C bus (SMARC pin names I2C_GP_CK and I2C_GP_DAT) is routed to the feature connector. There are no devices connected to this bus on the MB-SMARC-100100-1.

5.1.2 SMBus / Power Management I²C Bus

The SMBus (System Management Bus) (SMARC pin names I2C_PM_CK and I2C_PM_DAT) is accessible on the feature connector. There are no devices connected to this bus on the MB-SMARC-100100-1.

5.2 Operating Systems

5.2.1 Supported Operating Systems

The MB-SMARC-100100-1 supports various Operating Systems:

- Microsoft® Windows® 10
- Linux (i.e. Ubuntu 20.10 or later)

Other Operating Systems are supported on request.

Please contact [TQ-Support](#) for further information about supported Operating Systems.

5.2.2 Driver Download

The MB-SMARC-100100-1 module is well supported by the Standard Operating Systems, which already include most of the drivers required. It is recommended to use the latest drivers for best performance and the full feature set of the module.

Please contact [TQ-Support](#) for further driver download assistance.



6. SAFETY REQUIREMENTS AND PROTECTIVE REGULATIONS

6.1 EMC

The MB-SMARC-100100-1 was developed according to the requirements of electromagnetic compatibility (EMC). Depending on the target system, anti-interference measures may still be necessary to guarantee that the limits for the overall system including housing are met.

6.2 ESD

In order to avoid interspersions on the signal path from the input to the protection circuit in the system, the protection against electrostatic discharge should be arranged directly at the inputs of a system. Most external interfaces are protected using ESD protection diodes. Measurements for ESD protection have to be done with the electronic parts mounted in a housing. Since TQ-Systems GmbH does not offer a housing for the MB-SMARC-100100-1, no special preventive measures are taken.

6.3 Shock & Vibration

The MB-SMARC-100100-1 is designed to be insensitive to shock and vibration and impact.

6.4 Operational Safety and Personal Security

Due to the occurring voltages (≤ 20 V DC), tests with respect to the operational and personal safety have not been carried out.

6.5 Environment protection

6.5.1 RoHS

The MB-SMARC-100100-1 is manufactured RoHS compliant.

- All components and assemblies are RoHS compliant
- The soldering processes are RoHS compliant



7. ENVIRONMENT PROTECTION

7.1 RoHS

The MB-SMARC-100100-1 is manufactured RoHS compliant.

- All used components and assemblies are RoHS compliant
- RoHS compliant soldering processes are used

7.2 WEEE®

The final distributor is responsible for compliance with the WEEE® regulation.

Within the scope of the technical possibilities, the MB-SMARC-100100-1 was designed to be recyclable and easy to repair.

7.3 REACH®

The EU-chemical regulation 1907/2006 (REACH® regulation) stands for registration, evaluation, certification and restriction of substances SVHC (Substances of very high concern, e.g., carcinogen, mutagen and/or persistent, bio accumulative and toxic). Within the scope of this juridical liability, TQ-Systems GmbH meets the information duty within the supply chain with regard to the SVHC substances, insofar as suppliers inform TQ-Systems GmbH accordingly.

7.4 EuP

The Eco Design Directive, also Energy using Products (EuP), is applicable to products for the end user with an annual quantity >200,000. The MB-SMARC-100100-1 must therefore always be seen in conjunction with the complete device. The available standby and sleep modes of the components on the MB-SMARC-100100-1 enable compliance with EuP requirements for the MB-SMARC-100100-1.

7.5 Battery

No batteries are assembled on the MB-SMARC-100100-1.

7.6 Packaging

By environmentally friendly processes, production equipment and products, we contribute to the protection of our environment. To be able to reuse the MB-SMARC-100100-1, it is produced in such a way (a modular construction) that it can be easily repaired and disassembled. The energy consumption of this subassembly is minimised by suitable measures. The MB-SMARC-100100-1 is delivered in reusable packaging.

7.7 Other Entries

By environmentally friendly processes, production equipment and products, we contribute to the protection of our environment.

The energy consumption of this subassembly is minimised by suitable measures.

Printed PC-boards are delivered in reusable packaging.

Modules and devices are delivered in an outer packaging of paper, cardboard or other recyclable material.

Due to the fact that at the moment there is still no technical equivalent alternative for printed circuit boards with bromine-containing flame protection (FR-4 material), such printed circuit boards are still used.

No use of PCB containing capacitors and transformers (polychlorinated biphenyls).

These points are an essential part of the following laws:

- The law to encourage the circular flow economy and assurance of the environmentally acceptable removal of waste as at 27.9.94 (source of information: BGBl I 1994, 2705)
- Regulation with respect to the utilization and proof of removal as at 1.9.96 (source of information: BGBl I 1996, 1382, (1997, 2860))
- Regulation with respect to the avoidance and utilization of packaging waste as at 21.8.98 (source of information: BGBl I 1998, 2379)
- Regulation with respect to the European Waste Directory as at 1.12.01 (source of information: BGBl I 2001, 3379)

This information is to be seen as notes. Tests or certifications were not carried out in this respect.

8. APPENDIX

8.1 Acronyms and Definitions

The following acronyms and abbreviations are used in this document.

Table 9: Acronyms

Acronym	Meaning
ATA	Advanced Technology Attachment
BIOS	Basic Input/Output System
CAN	Controller Area Network
CSI	Camera Serial Interface (MIPI)
DIP	Dual In-line Package
DP	Display Port
DVI	Digital Visual Interface
EDID	Extended Display Identification Data
eDP	embedded Display Port
EEPROM	Electrically Erasable Programmable Read-Only Memory
EMC	Electromagnetic Compatibility
ESD	Electrostatic Discharge
EuP	Energy using Products
FAE	Field Application Engineer
flexiCFG	Flexible Configuration
FR-4	Flame Retardant 4
FTDI	Future Technology Devices International
GPIO	General-Purpose Input/Output
HD	High Definition (Audio)
HDA	High-Definition Audio (Intel)
HDMI	High Definition Multimedia Interface
HPD	Hot Plug Detect
I/O	Input/Output
I2C	Inter-Integrated Circuit
I2S	Integrated Interchip Sound
IEEE®	Institute of Electrical and Electronics Engineers
IP	Ingress Protection
LCD	Liquid Crystal Display
LED	Light Emitting Diode
LTE	Long Term Evolution
LVDS	Low Voltage Differential Signal
MIPI	Mobile Industry Processor Interface
mPCIe	Mini Peripheral Component Interconnect Express
MTBF	Mean (operating) Time Between Failures
NC	Not Connected
OTG	On-The-Go

8.1 Acronyms and Definitions (continued)

Table 8: Acronyms (continued)

Acronym	Meaning
PC	Personal Computer
PCB	Printed Circuit Board
PCI	Peripheral Component Interconnect
PCIe	Peripheral Component Interconnect express
PCMCIA	People Can't Memorize Computer Industry Acronyms
PICMG®	PCI Industrial Computer Manufacturers Group
PWM	Pulse-Width Modulation
PWR	Power
RAM	Random Access Memory
REACH®	Registration, Evaluation, Authorisation (and restriction of) Chemicals
RJ45	Registered Jack 45
RMA	Return Merchandise Authorization
RoHS	Restriction of (the use of certain) Hazardous Substances
RS-232	Recommended Standard (serial interface)
SATA	Serial ATA
SD	Secure Digital
SGET	Standardization Group for Embedded Technologies
SIM	Subscriber Identity Module
SM	System Management
SMARC	Smart Mobile ARChitecture
SMB	System Management Bus
SPI	Serial Peripheral Interface
SSD	Solid-State Drive
SVHC	Substances of Very High Concern
UEFI	Unified Extensible Firmware Interface
UMTS	Universal Mobile Telecommunications System
UN	United Nations
USB	Universal Serial Bus
VGA	Video Graphics Array (640 × 480)
WEEE®	Waste Electrical and Electronic Equipment
WES	(Microsoft®) Windows® Embedded Standard
WLAN	Wireless Local Area Network
WWAN	Wireless Wide Area Network



8.2 References

Table 10: Further Applicable Documents and Links

No.	Name	Rev. / Date	Company
(1)	SMARC (Smart Mobility ARChitecture) Hardware Specification	Version 2.1, March 23, 2020	SGEI
(2)	SMARC (Smart Mobility ARChitecture) Design Guide	Rev. 2.1.1, April 29, 2021	SGEI



Singel 3 | B-2550 Kontich | Belgium | Tel.+32(0)3 458 30 33
info@alcom.be | www.alcom.be

Rivium 1e straat 52 | 2909 LE Capelle aan den IJssel | The Netherlands
Tel.+31(0)10 288 25 00 | info@alcom.nl | www.alcom.nl

A STELIAU COMPANY ●●●●

