

Welcome

Unboxing Silicon Labs' Latest
Bluetooth SoC for Energy
Harvesting

tech  lks



Singel 3 | B-2550 Kontich | Belgium | Tel. +32 (0)3 458 30 33
info@alcom.be | www.alcom.be
Rivium 1e straat 52 | 2909 LE Capelle aan den IJssel | The Netherlands
Tel. +31 (0)10 288 25 00 | info@alcom.nl | www.alcom.nl

Agenda

- 01** The Problem with Batteries..
- 02** Alternative energy sources for Ambient IoT
- 03** Unboxing xG22E
- 04** Resources: xG22E Explorer Kit e-peas Shields
- 05** Q&A

The problem with batteries...

Tristan Cool

The Problem with Batteries for IoT



15 billion
batteries are thrown in
land-fills every year

More than 15 billion batteries are thrown in land-fills around the world every year (900,000 tons of hazardous waste)

The average household purchases over 90 batteries annually most have much less than 10-year lifetime

Batteries are slowing down the growth of IoT

- 25 billion IoT devices predicted by 2025 would require 6 million battery replacements every day
- In industrial setting with 1,000 sensors, the annual replacement of over 350 batteries—typically exceeding one per day—incurs significant recurring costs, often surpassing the batteries' own price.
- IoT is compromised when sensor polling rate, payload size, transmission rate and range are lowered due to lack of power.
- Systems need to integrate energy awareness decision making

Battery regulations



- National Electric Code (**NEC**) is introducing **new requirements on battery collection and recycling** as well as mandating the **elimination of batteries** in certain devices.
- **More and more countries** are following the movement (NEC US, NEC Europe, Japan, Australia, Canada)
- [17 AUG 2023] – **European Commission – Batteries Regulation**
- **Biden-Harris Administration Announces \$62 Million to Lower Battery Recycling Costs Across the Nation**
- These upcoming regulations impact IoT device design.
This is the beginning of a new era of IoT product development

Source:

<https://www.lightnowblog.com/2023/05/2023-nec-prohibits-battery-only-wall-light-switches/>

https://environment.ec.europa.eu/news/new-law-more-sustainable-circular-and-safe-batteries-enters-force-2023-08-17_en

Energy Harvest – Application Profiles



SOLAR - OUTDOOR

LOGISTICS / LIVESTOCK TRACKING

- Bluetooth /Bluetooth Long Range
- 802.15.4 Mesh

- 10 mW/cm²

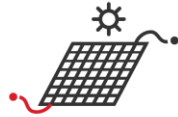

SOLAR - INDOOR

ASSET TRACKING / SMART BUILDING SENSORS

- Bluetooth
- 802.15.4 Mesh

- 10 μ W/cm²



KINETIC PULSE

SMART SWITCHES

- Bluetooth / Bluetooth Mesh
- 802.15.4 Mesh

- 120~300 μ J/press

Energy Harvest – Application Profile

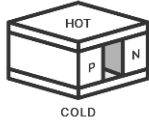

THERMAL

MACHINE MONITORING

- Bluetooth / Bluetooth Mesh
- 802.15.4 Mesh
- 1-10 mW/cm²

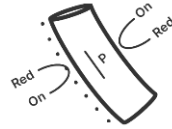

VIBRATION / PIEZO

FACTORY AUTOMATION / AGRICULTURE / TPMS

- Bluetooth
- 802.15.4 Mesh
- 100 μ W/cm²

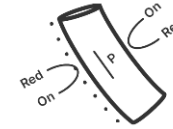

INDUCTION

ELECTRIC SUB-METERING

- Zigbee Green Power
- 802.15.4 Mesh
- 100 μ W/cm²

Alternative Battery/Storage



CONVENTIONAL BATTERY

Environmentally harmful

Lithium

Nickel-Cadmium

Nickel-Metal-Hydrate

Silver Oxide

1.2~3V cells

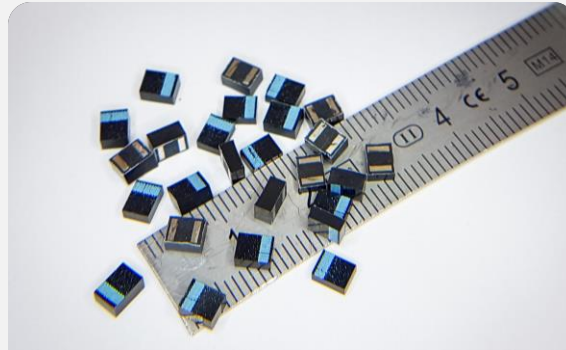

MICRO BATTERY

Solid-state design

Embedded

Surface-mount

Customizable

2.2~3V cells

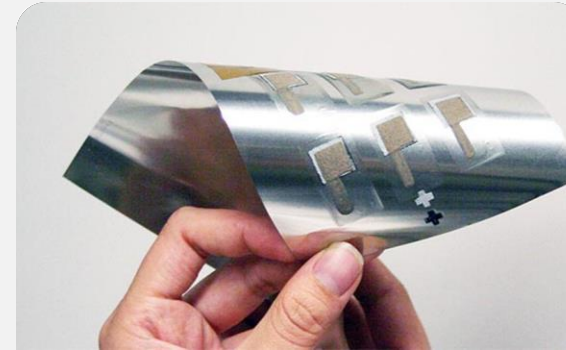

PRINTED BATTERY

Printed anode/cathode

Pliable thin-film

Customizable

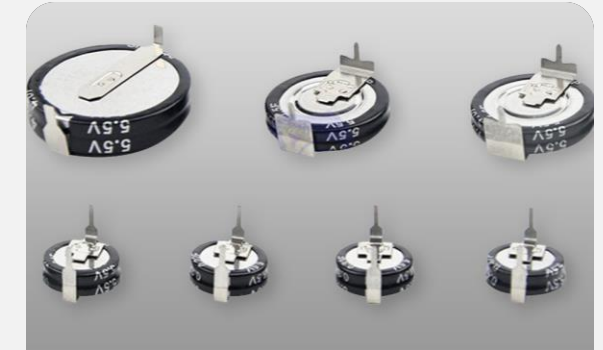

SUPER CAPACITORS

Environmentally friendly

Quick energy delivery

Several hours of self-discharge

Understanding IoT Architectures for Energy Harvesting

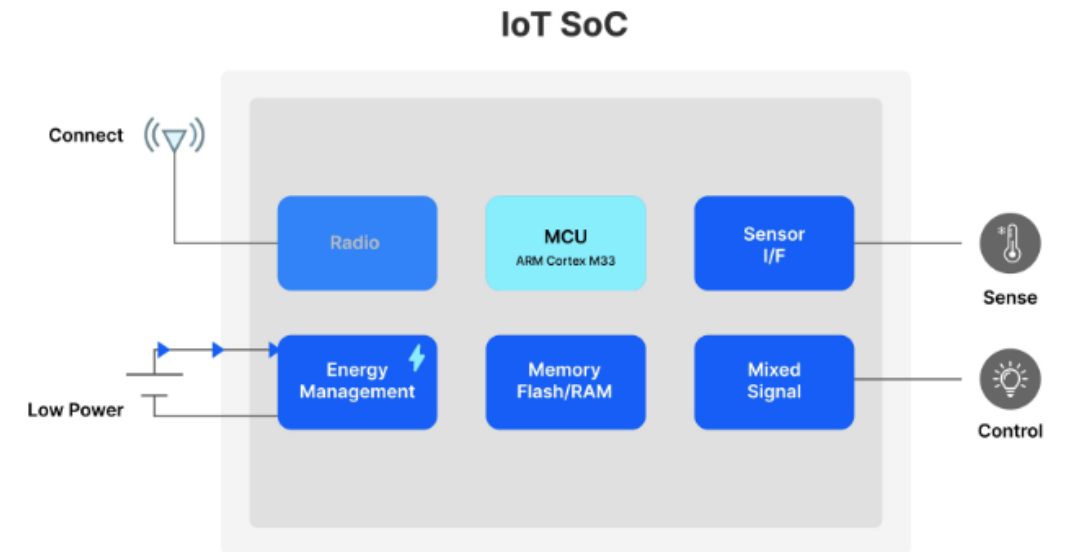
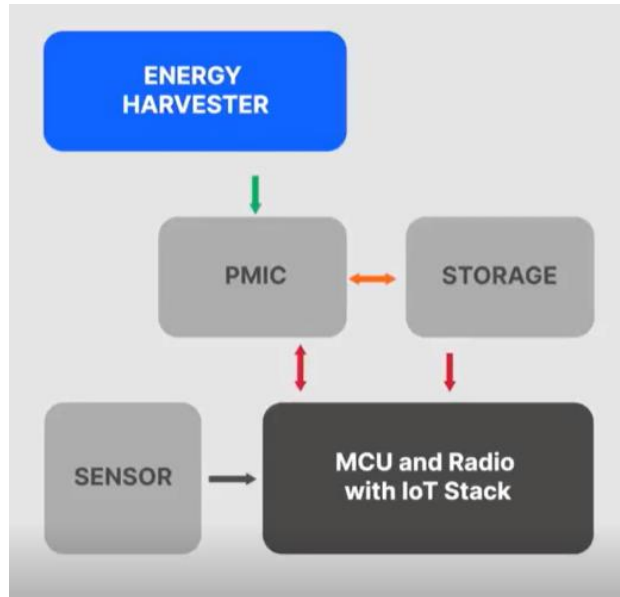

- **Energy Harvester:** harness ambient energy
- **Storage:** energy bank
- **PMIC:** power management and transformation
- **MCU and Radio:**
 - Application and communication
 - energy-based decision making ; sleep and wake control

The IoT SoC Platform is responsible for:

- assessing available energy
- determining when to wake up peripheral systems
- executing system actions...or remain asleep.
- Managing communication payload and transmitting

'Ambient IoT' for 'Energy Harvesting'

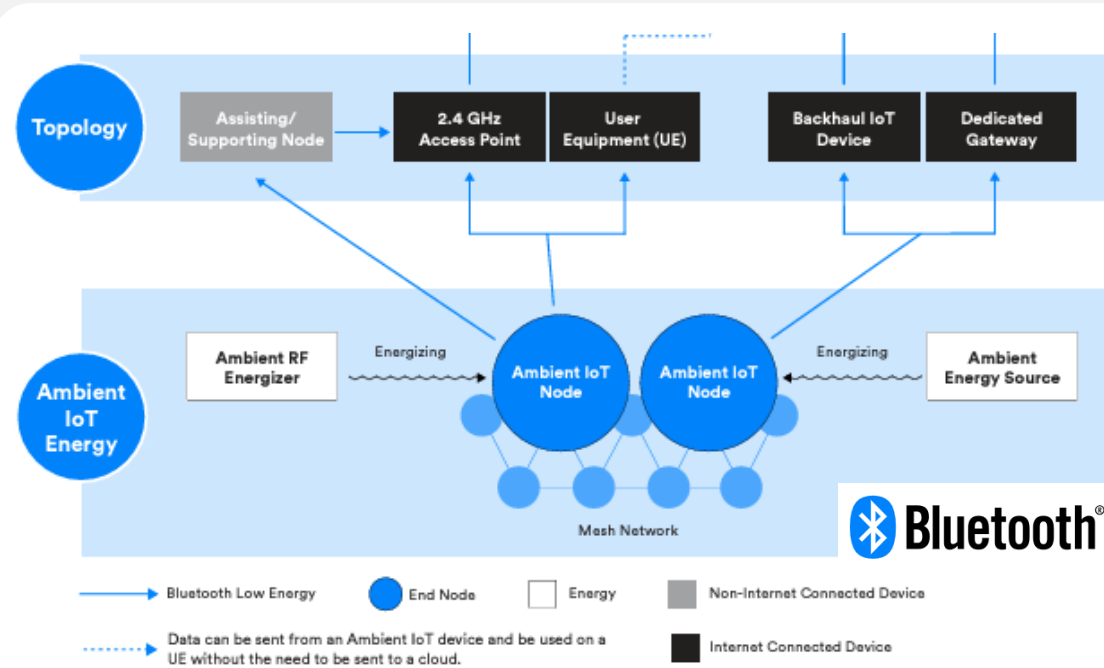

■ BTSIG preparing for battery-less, energy-harvested IoT

- FEB, 2024 – *The Role of Bluetooth Technology in the Ambient IoT*
- Reference [link](#)

The Connectivity Standards Alliance Releases Green Power 1.1.2 for Zigbee-based Energy-harvesting Technology



■ CSA launching ZGP 1.1.2 - 24Q2 GSDK

- MARCH, 2024 – *CSA Releases Green Power 1.1.2 for Zigbee-based Energy-Harvesting Technology*
- Reference [link](#)

Unboxing xG22E

Tristan Cool

Introducing EFR32xG22E

Lowest Power, Energy-Efficient Wireless SoC

Wireless SoCs providing
Ultra-Low Power suited for
deep-sleep **Extended**
Battery or **Battery-Less**
Applications



- **Ultra-fast, Low-Energy cold-start**
 - Power on Reset (PoR) in 8ms
 - Consumes less than 150μJ
- **Ultra-fast, Low-Energy deep sleep wake-up**
 - EM4 wakeup in less than 1.83ms
 - Consumes 16.6μJ in wake-up energy
 - 10+ year coin cell battery operation for ultra-low power or extended storage applications
- **Power-efficient energy mode transition**
 - Optimized for smooth transitions in and out of energy modes
 - Mitigates current spikes or in-rush to prevent harm to batteries or alternate storage
- **Reliable Wireless and Long Range**
 - Multiprotocol 2.4 GHz wireless SoC with High-Performance RF
 - Bluetooth LE, Proprietary, Zigbee, and Zigbee Green Power
- **Pin compatible with xG22 and xG27 SoCs**
 - Pin compatible QFN32 and QFN40 packages for easy migration and rapid time to market

xG22E: Ideal for Ultra-low Energy, Ambient IoT, and Energy-Harvesting



- 5x5 QFN40 (26 GPIO), **AEC-Q100**
- 4x4 QFN32 (18 GPIO)

DIFFERENTIATED FEATURES

- **Efficient, Low-Energy Cold Start**
 - Boot-up time less than 8ms
 - Energy consumption under 150uJ
- **Low-Energy Deep Sleep wake-up**
 - Consuming less than 17uJ
- **Power-efficient energy mode transition**
 - Optimized to smoothly transition out of energy modes
 - Mitigates current spikes or inrush
- **RFSense with OOK mode**
 - Ultra low-power receive mode to wake-up MCU from EM2 or EM4
 - Results in longer battery life
- **PLFRCO**
 - Eliminates need for 32 KHz XTAL and lowers overall system cost
- **16-bit ADC**
 - Up to 14-bit ENOB for better analog sensing

DEVICE SPECIFICATIONS

- **High Sensitivity 2.4 GHz Radio**
 - -Up to +6 dBm TX
 - -98.9 dBm RX @ BLE 1 Mbps
 - -106.7 dBm RX @ BLE 125 kbps
 - -102.3 dBm RX @ 15.4
- **Efficient ARM® Cortex®-M33**
 - Operating Frequency: Up to 76.8 MHz
 - 512kB Flash, 32kB RAM
 - Low Power
 - 27 μ A/MHz
 - 3.4 mA TX @ 0 dBm
 - 2.5 mA RX (BLE 1 Mbps)
 - 1.4 μ A EM2 sleeps
 - 0.17 μ A EM4
- **Secure**
 - Secure Vault Base
 - ARM® TrustZone
- **Wide Operating Range**
 - 1.71 to 3.8 volts
 - +125°C operating temperature
- **PLFRCO**
 - 500 PPM LFRCO

xG22E Optimizations

COLD START

▪ Efficient, Low-Energy Cold Start

- Boot-up time less than 8ms
- Energy consumption under 150uJ

▪ For energy-harvest devices that require booting up from *zero-power level*

ENERGY MODE SLEEP WAKE-UP

▪ Low-Energy Deep Sleep wake-up ; Smooth energy mode transitions

- Consuming less than 17uJ
- Current in-rush spikes mitigated between rapid energy mode transition to protect batteries and capacitors

▪ For devices that spend extremely lengthy periods in deep sleep with *frequent wake-ups between Tx*

- Extends battery-life
- Allows for energy-based wake decision making for energy-harvesting
- Multi-source wake-up (RF Sense, GPIO, RTC)

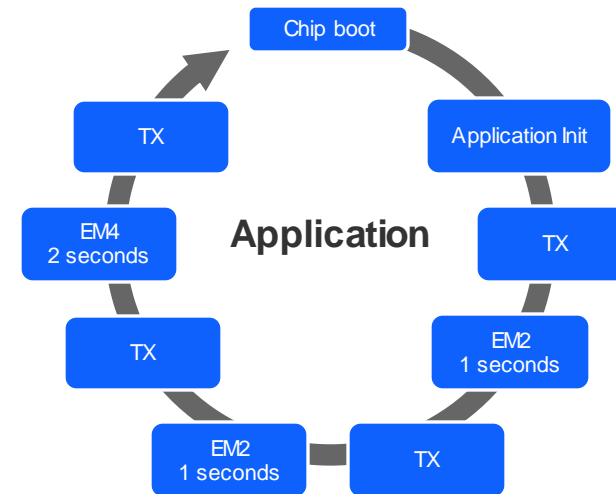

xG22

Startup time: 18.8 ms
Startup Energy: 185 uJ
EM4 wake-up: 9.2 ms
EM4 energy: 76.7 uJ



xG22E

Startup time: 8.01 ms (-42%)
Startup Energy: 150 uJ (-19%)
EM4 wake-up: 1.83 ms (-80%)
EM4 wake-up energy: 16.6 uJ (-78%)

Target Markets and Applications

■ Home and Life

- Smart Home Doors & Switches
- Smart Sensors
- Smart Appliances
- Gaming Electronics
- Remote Controllers

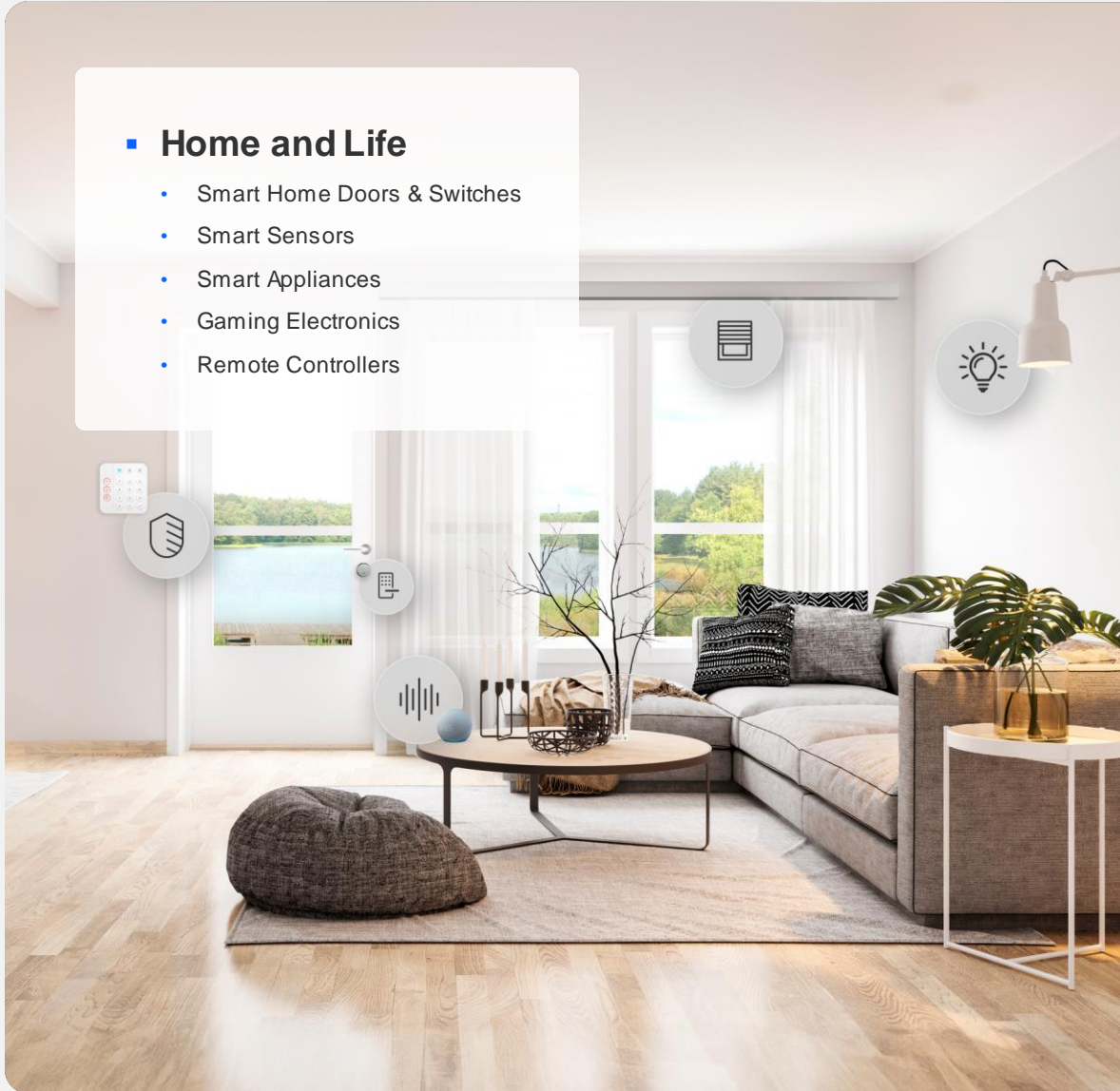

■ Industrial and Commercial

- Asset Tracking & Cold Chain
- Electronic Shelf Labels
- Smart Building Sw itches and Sensors
- Smart Sub-Metering
- Condition Monitoring , Factory Automation
- Tire Pressure Monitor Sensors
- Agriculture

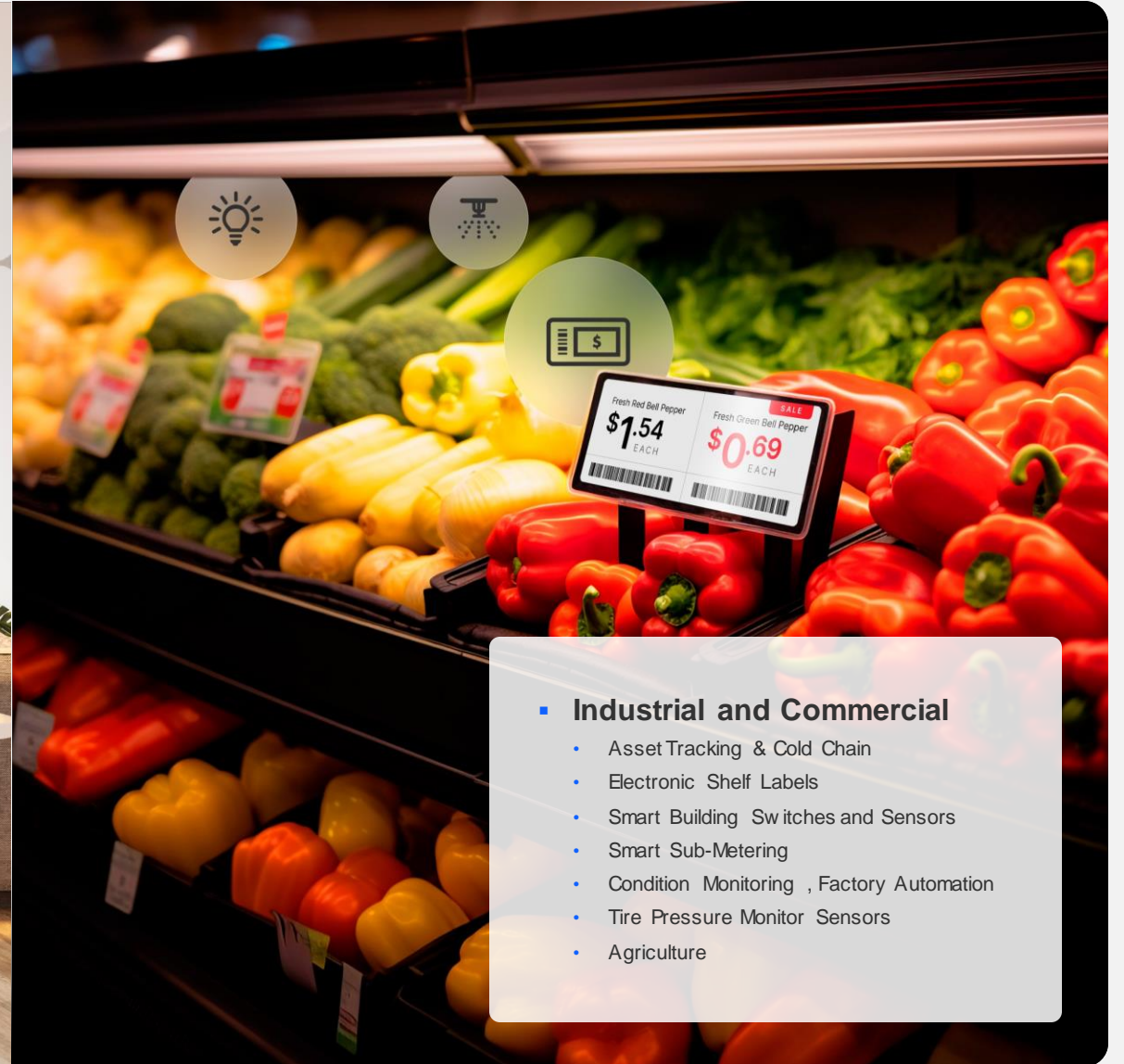

xG22E Value Proposition

- **Minimize Battery Replacement and Recharging**
 - Low run-time and wake-up currents in sleep modes
 - Extended battery life for ultra-low power beacon applications and sensors
- **Compatibility with variety of power sources, power management and harvesters**
 - Exploration into new battery technologies and super-capacitors
 - Compatible with multitude of power management IC's (built-in DC-DC Converter and Voltage Regulator)
 - Integration with energy-harvesting hardware
- **Silicon Lab's first part in Ambient IoT and energy-harvesting**
 - Multiple configurations for energy – DC-DC bypass, LFRCO, Radio PA, etc.
 - Based on existing Series 2 catalogue – pin-to-pin compatible. Short turnaround time to market!
 - Compliant with CSA's energy-harvesting protocol Zigbee Green Power 1.1.2
- **Multiple deep sleep wake-up options**
 - RFSense, GPIO and RTC wake-up sources from deepest EM4 sleep mode.
- **Silicon Labs' Proven Application Expertise**
 - Partner reference designs
 - Simplicity Studio streamlines the development process, reducing costs and accelerating time-to-revenue



Resources



Getting Started with EFR32xG22E



- **NEW** Explorer Kit – June 2024
 - Isolated debug circuit for lowest power
 - mikroBus socket
 - Qwiic connector
- **Contents**
 - 1x Explorer board

Part Number	Description
EK2710A- BRD2710A	EFR32MG22E Explorer Kit



- **NEW** Explorer Kit Shield – TBA (24Q3)
 - mikroBus socket
 - Qwiic connector
 - E-peas PMIC shields

- Contents**
- 1 Explorer board
 - 3x Energy Shields

Part Number	Description
EK8200A	EFR32xG22E Explorer e-peas shield
BRD8201A	Alternate battery and super-capacitors
BRD8202A	AEM0300 PMIC for kinetic pulse sources
BRD8203A	AEM13920 PMIC for dual energy source



- **Radio Board kits – May 2024**
 - Uses existing WSTK boards
 - Uses existing software tools

- Contents**
- 1x radio board

Part Number	Description
xG22E-RB4415A	EFR32xG22E 2.4 GHz +6 dBm Radio Board (QFN40)
SLWRBRD4415A	

Introducing xG22E Explorer Kit e-peas Shields for energy-harvesting



NEW Explorer Kit: redesigned to minimize leakage and isolation of debugger circuit

Shield interface expansion boards:

A: Transistor rectifier

B: Diode rectifier

C: Over-voltage protection

D: Additional input capacitance

Shield #1 for alternative battery technologies and storage options with measurements

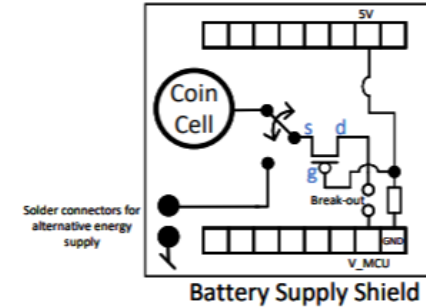

Battery Supply Shield

Shield #2 dedicated for evaluating kinetic/pulse harvest generators with measurements.

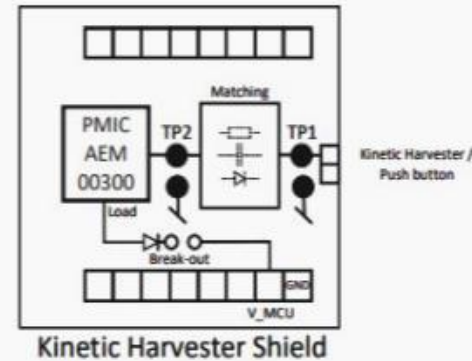

Kinetic Harvester Shield

Shield #3 for dual harvest sources (PV, Thermal, Vibration, bricks) with measurements

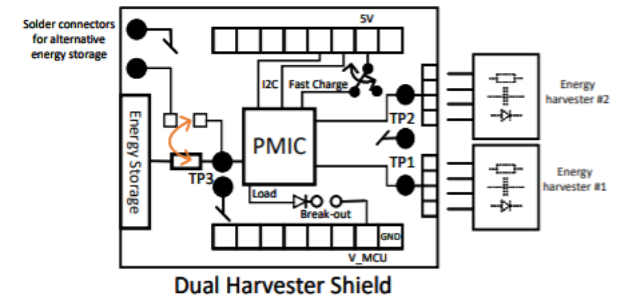

Dual Harvester Shield