



MagAlpha MA782

Low-Power Angle Sensor with Integrated Wake-Up and Interrupt Logic

PRELIMINARY SPECIFICATIONS SUBJECT TO CHANGE

DESCRIPTION

The MA782 detects the absolute angular position of a permanent magnet (typically a diametrically magnetized cylinder on a rotating shaft). With its power cycling ability, the sensor is suitable for applications requiring low average power. The timing can be controlled by an on-chip clock or by an external controller. Flags are available for detecting a definable amount of angle change.

The MA782 supports a wide range of magnetic field strengths and spatial configurations. Both end-of-shaft and off-axis (side-shaft mounting) configurations are supported.

The MA782 features magnetic field strength detection with programmable thresholds to allow the sensing of the magnet position relative to the sensor for creation of functions such as the sensing of axial movements or for diagnostics.

On-chip non-volatile memory provides storage for configuration parameters, including the reference zero angle position, the power cycling parameters, the filter window affecting the output resolution and magnetic field detection thresholds.

FEATURES

- 8 Bit to 12 Bit Resolution Absolute Contactless Angle Encoder
- 1 μ A Current Consumption in Idle Mode
- 10mA Current Consumption in Active Mode
- Internal or External Power Cycling Control
- Warning on Change Flags
- SPI Serial Interface for Digital Angle Readout and Chip Configuration
- Magnetic Field Strength Alarm
- 3.3V Supply
- -40°C to +125°C Operating Temperature
- Available in a QFN-14 (2mmx2mm) Package

APPLICATIONS

- General Purpose Angle Measurement
- Portable Devices
- Low Power Rotary Knob

All MPS parts are lead-free, halogen-free, and adhere to the RoHS directive. For MPS green status, please visit the MPS website under Quality Assurance. "MPS", the MPS logo, and "Simple, Easy Solutions" are trademarks of Monolithic Power Systems, Inc. or its subsidiaries.

TYPICAL APPLICATION

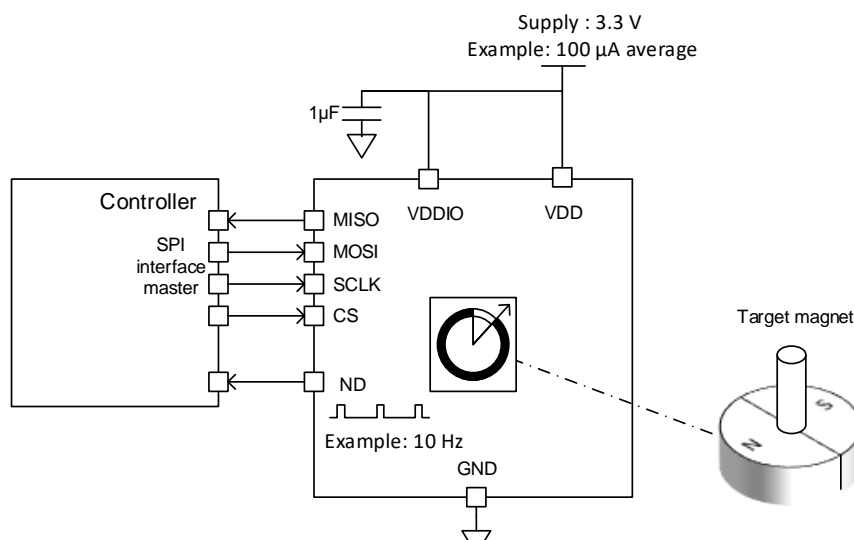

ORDERING INFORMATION

Part Number*	Package	Top Marking	MSL Rating
MA782GGU	QFN-14 (2mmx2mm)	See Below	1

* For Tape & Reel, add suffix -Z (e.g. MA782GGU-Z)

TOP MARKING

KVY
LLL

KV: Product code of MA782GGU

Y: Year code

LLL: Lot number

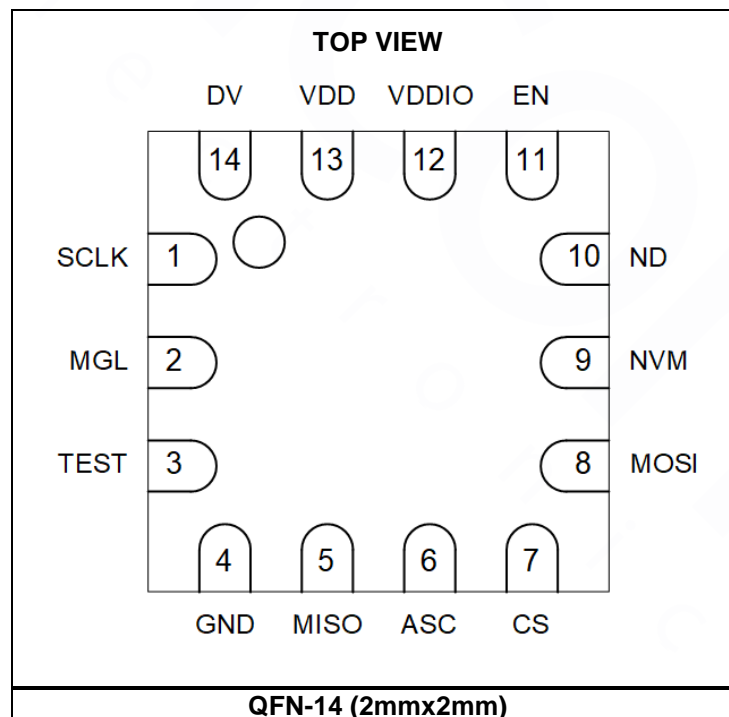
PACKAGE REFERENCE

PIN FUNCTIONS

Package Pin #	Name	Description
1	SCLK	Clock (SPI). Input.
2	MGL	Digital output indicating field strength below MGLT level.
3	TEST	Connect to ground.
4	GND	Supply ground.
5	MISO	Data out (SPI). Output.
6	ASC	Auto sampling cycle. Input. Connect to GND if not used.
7	CS	Chip select (SPI). Input.
8	MOSI	Data in (SPI). Input.
9	NVM	Non-volatile memory. Output. Indicates that the chip is busy accessing the non-volatile memory.
10	ND	New data. Output. In ASC mode, ND indicates that new data is ready to be read, or the displacement exceeds the defined threshold.
11	EN	Enable. Input. Switches the sensor to active mode. Connect to GND if not used.
12	VDDIO	Supply for the IO 1.8V to 3.3V. Allows communication at a voltage between 1.8 and 3.3V
13	VDD	Supply 3.3V.
14	DV	Data valid. Output. When active, DV indicates that the digital filter has stabilized.

ABSOLUTE MAXIMUM RATINGS ⁽¹⁾

Supply voltage	-0.5V to +4.6V
Input pin voltage (V _I)	-0.5V to +6.0V
Output pin voltage (V _O)	-0.5V to +4.6V
Continuous power dissipation (T _A = +25°C) ⁽²⁾2.0W
Junction temperature	125°C
Lead temperature	260°C
Storage temperature.....	-65°C to 150°C

ESD Rating

Human-body model (HBM)	±2kV
Charged-device model (CDM).....	±750V

Thermal Resistance ⁽³⁾	θ_{JA}	θ_{JC}
QFN-14 (2mmx2mm)	90.....	20 ... °C/W

NOTES:

- 1) Exceeding these ratings may damage the device.
- 2) The maximum allowable power dissipation is a function of the maximum junction temperature T_J (MAX), the junction-to-ambient thermal resistance θ_{JA}, and the ambient temperature T_A. The maximum allowable continuous power dissipation at any ambient temperature is calculated by P_D (MAX) = (T_J (MAX) - T_A) / θ_{JA}.
- 3) Measured on JE51-7, 4-layer PCB.

ELECTRICAL CHARACTERISTICS
VDD = 3.3V, 45mT < B < 100mT, Temp = -40°C to +125°C, unless otherwise noted.

Parameter	Symbol	Condition	Min	Typ	Max	Units
Recommended Operating Conditions						
Supply voltage	V _{DD}		3.0	3.3	3.6	V
I/O supply voltage	V _{DDIO}		1.8		3.6	V
Operating temperature	T _{OP}		-40		+125	°C
Applied magnetic field	B		30	60		mT
Supply current						
Supply current when active	I _{ACTIVE}			10		mA
Supply current when idle	I _{IDLE}	Below 85°C		1		µA
Absolute Output – Serial						
Effective resolution		±3σ deviation of the noise distribution	8		12	bit
Noise RMS		1σ of the noise distribution	0.015		0.2	deg
Refresh rate		Active mode	850	980	1100	kHz
Data output length			16		16	bit
Response Time						
Power up time		After setting VDD at 3.3 V		600		µs
Startup time	t _{STARTUP}	From Idle to Data Valid when FW = 0		35		µs
Latency ⁽⁴⁾		Constant speed propagation delay when active. The latency is equal to the filter time constant τ + 3µs	4		16000	µs
Filter cutoff frequency ⁽⁴⁾	F _{CUTOFF}	Depends on FW (Filter Window)	5		160000	Hz
128MHz Internal High frequency CLK error (affects all timings)		Room temperature	-13		+12	%
TCYC error		Room temperature	-15		+15	%
Accuracy						
INL at 25°C		At room temperature over the full field range		0.7		deg
INL between -40°C to +125°C ⁽⁵⁾		Over the full temperature range and field range		1.1		deg
Output Drift						
Temperature induced drift at room temperature ⁽⁵⁾				0.01		deg/°C
Temperature induced variation ⁽⁵⁾		From 25°C to 85°C		0.5		deg
		From 25°C to 125°C		0.7		deg
Magnetic field induced ⁽⁵⁾				0.01		deg/mT
Voltage supply induced ⁽⁵⁾				0.35		deg/V

ELECTRICAL CHARACTERISTICS (continued)

VDD = 3.3V, 45mT < B < 100mT, Temp = -40°C to +125°C, unless otherwise noted.

Parameter	Symbol	Condition	Min	Typ	Max	Units
Magnetic Field Detection Thresholds						
Accuracy ⁽⁵⁾				5		mT
Hysteresis ⁽⁵⁾	MagHys			6		mT
Temperature drift ⁽⁵⁾				-600		ppm/°C
Digital I/O						
Input high voltage ⁽⁵⁾	V _{IH}	V _{DDIO} = 3.3V	2.5		5.5	V
		V _{DDIO} = 1.8V	1.2		5.5	V
Input low voltage ⁽⁵⁾	V _{IL}	V _{DDIO} = 3.3V	-0.3		+0.8	V
		V _{DDIO} = 1.8V	-0.3		+0.4	V
Output low voltage ⁽⁵⁾	V _{OL}	I _{OL} = 4mA, V _{DDIO} = 3.3V			0.4	V
		I _{OL} = 4mA, V _{DDIO} = 1.8V			0.4	V
Output high voltage ⁽⁵⁾	V _{OH}	I _{OL} = 4mA, V _{DDIO} = 3.3V	2.4			V
		I _{OL} = 4mA, V _{DDIO} = 1.8V	1.2			V
Falling edge slew rate ⁽⁴⁾	T _F	CL = 50pF		0.7		V/ns

Notes:

- 4) Guaranteed by design.
5) Guaranteed by characteristic test.

TYPICAL CHARACTERISTICS

VDD = 3.3V, Temp = 25°C, unless otherwise noted.

Error curves at 25°C

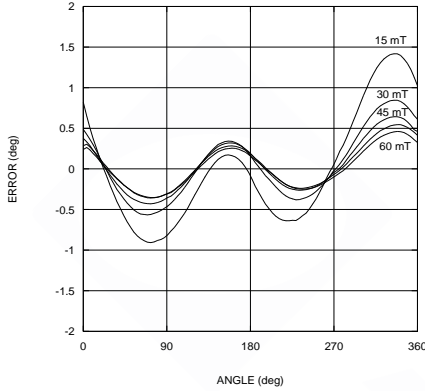

Noise Spectrum at 50mT with FW = 10

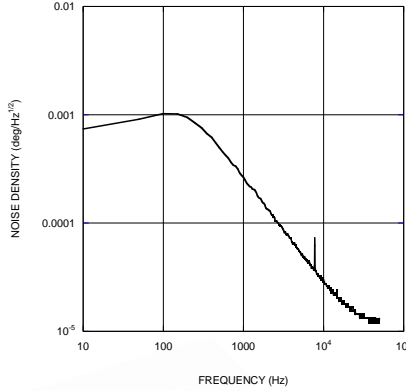

Filter Transfer Function with FW = 10

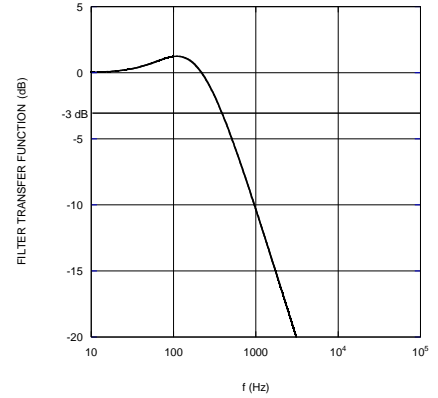

Supply current when active at VDD = 3.3V

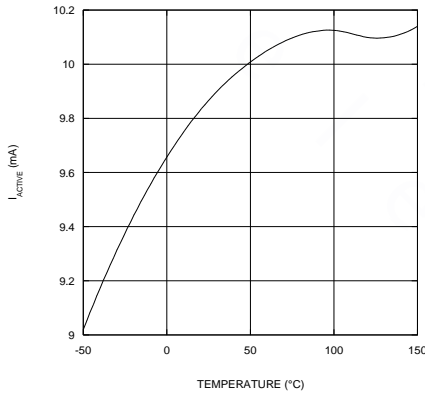

Supply current when Idle at VDD = 3.3V

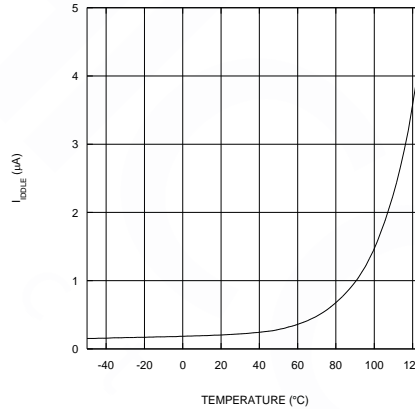

FUNCTIONAL BLOCK DIAGRAM

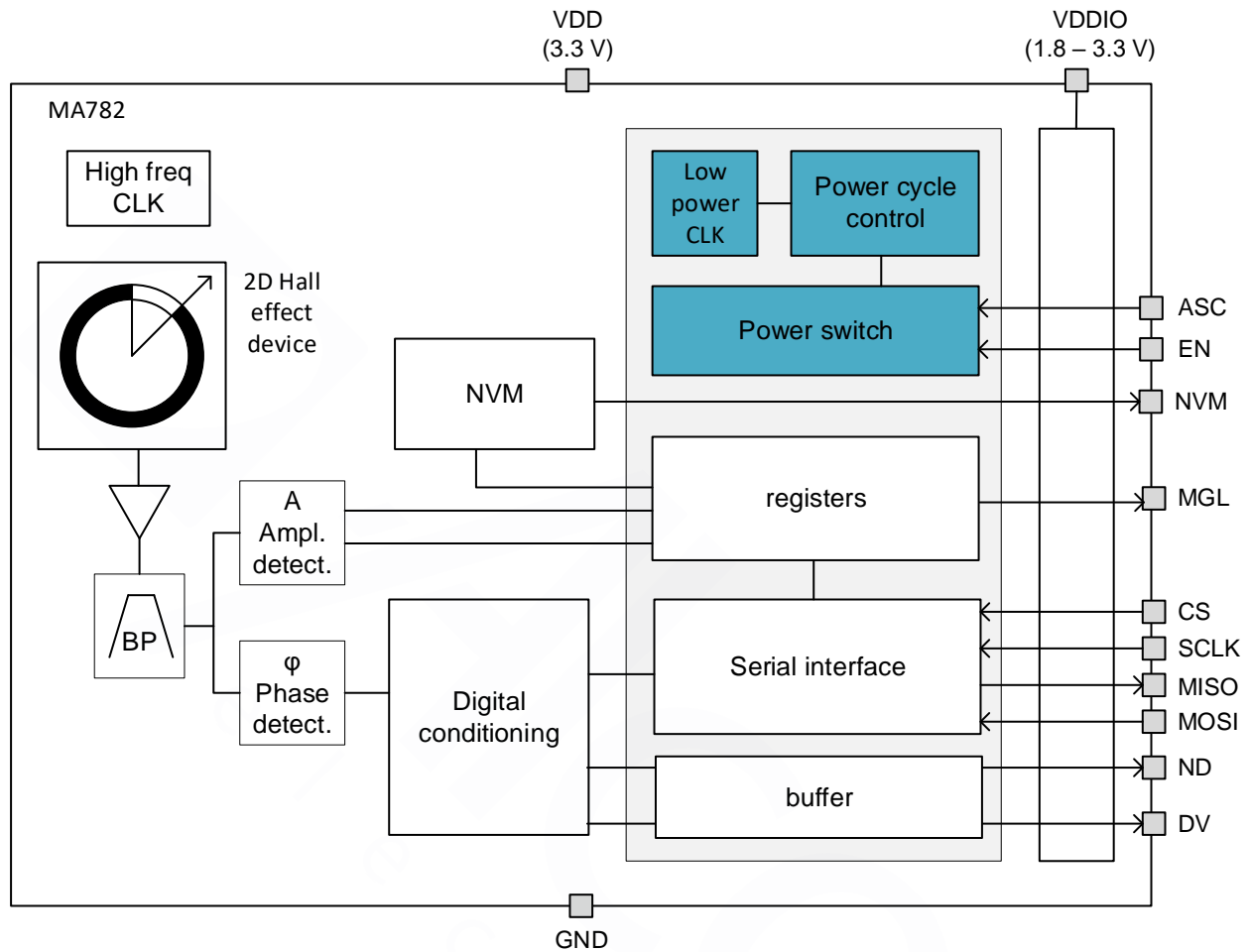

Figure 1: Functional Block Diagram (Grey Zone Block Operates in Idle Mode)

OPERATION

Sensor Front-End

The magnetic field is detected with integrated Hall devices located in the center of the package. The angle is measured using the *Spinaxis™* method, which directly digitizes the direction of the field without complex arctangent computation or feedback loop-based circuits (interpolators).

The *Spinaxis™* method is based on phase detection and generates a sinusoidal signal with a phase that represents the angle of the magnetic field. The angle is then obtained by a time-to-digital converter, which measures the time between the zero crossing of the sinusoidal signal and the edge of a constant waveform (see Figure). The time-to-digital is output from the front-end to the digital conditioning block.

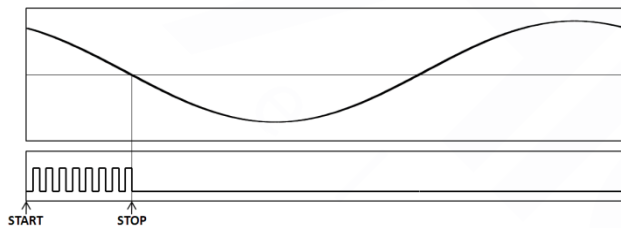

Figure 2: Phase Detection Method

Top: Sine Waveform

Bottom: Clock of Time-to-Digital Converter

The output of the front-end delivers a digital number proportional to the angle of the magnetic field at the rate of 1MHz in a straightforward and open-loop manner.

Digital Filtering

The front-end signal is further treated to achieve the final effective resolution. The filter transfer function can be calculated with Equation (1):

$$H(s) = \frac{1}{1 + \tau s} \quad (1)$$

Where τ is the filter time, which varies depending on the chosen filter window. Table 15 shows the values of τ for different filter window sizes.

To save power, the front-end and the digital filtering are disabled in idle mode, but the SPI block works continuously to provide the angle.

Sensor - Magnet Mounting

The sensitive volume of the MA782 is confined in a region less than 100µm wide and has multiple integrated Hall devices. This volume is in the center of the QFN package (see). The sensor detects the angle of the magnetic field projected in a plane parallel to the package’s upper surface. This means that the only relevant magnetic field is the in-plane component (X and Y components) in the middle point of the package.

By default, when looking at the top of the package, the angle increases when the magnetic field rotates clockwise. The zero angle of the unprogrammed sensor is where the cross indicates the sensitive point (see Figure 3). Both the rotation direction and the zero angle can be programmed.

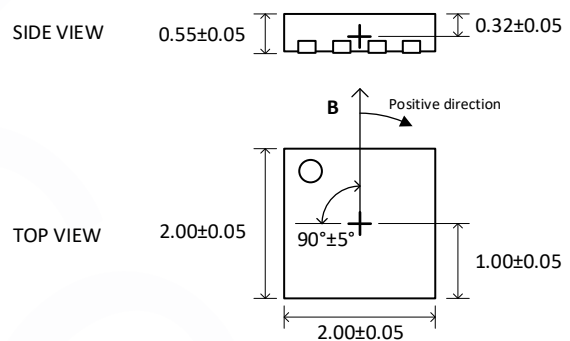

Figure 3: The cross is the sensitive point and the arrow B represents the default zero angle

This type of detection provides flexibility to design an angular encoder. The sensor requires the magnetic vector to remain within the sensor plane with a field amplitude of at least 30mT. The MA782 can work with fields smaller than 30mT, but the linearity and resolution performance may deviate from the specifications. The most straightforward mounting method is to place the MA782 sensor on the rotation axis of a permanent magnet, such as a diametrically magnetized cylinder (see Figure 4).

The recommended magnet is a Neodymium alloy (N35) cylinder with dimensions Ø5x3mm inserted into an aluminum shaft with a 1.5mm

air gap between the magnet and the sensor (surface of package). For optimum linearity, the sensor is positioned with a precision of 0.5 mm.

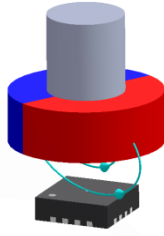

Figure 4: End-of-Shaft Mounting

If the end-of-shaft position is not available, the sensor can be positioned away from the rotation axis of a cylinder or ring magnet (see Figure 5). In this case, the magnetic field angle is no longer directly proportional to the mechanical angle. The MA782 can be adjusted to compensate for this effect and recover the linear relation between the mechanical angle and the sensor output. With multiple pole pair magnets, the MA782 indicates multiple rotations for each mechanical turn.

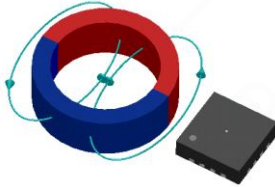

Figure 5: Side-Shaft Mounting

The different power modes

The MA782 has 3 power modes:

1. **Active:** The sensor runs without interruption and the current consumption is I_{ACTIVE} (see Electrical Characteristics on page 4).
2. **Idle:** The sensor front-end powers down; only the SPI communication interface and memory blocks work. The current consumption is I_{IDLE} (see Electrical Characteristics on page 4).
3. **ASC (Automatic Sampling Cycle):** The device automatically switches between active and idle mode. Figure 6 shows a cycle.

Power Mode	Average Supply Current i
Active	I_{ACTIVE}
ASC	$I_{IDLE} < i < I_{ACTIVE}$
Idle	I_{IDLE}

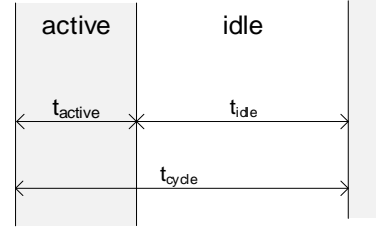

Figure 6: Timing of a Power Cycle

Combining these 3 power modes the MA782 can be operated in different ways.

Continuous ASC

In ASC mode, the on-chip low-power clock continuously runs to control the sensor's power cycle, according to the active and cycle time stored in the register.

In the minimum configuration, the MA only has SPI connections. The master device can question the MA782 at any time, the same way it does in Active mode (see Figure 7). The difference is that the average power consumption is low and the refresh rate is determined by the user parameter TCYC.

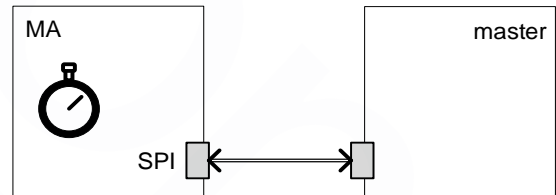

Figure 7: Minimum Configuration for Continuous ASC

The SPI output updates at the end of the active period.

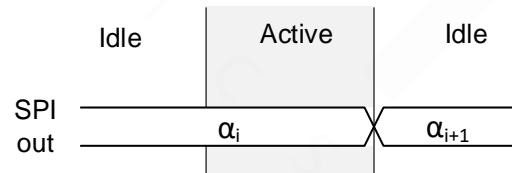

Figure 8: Signal Timing for ASC Mode

Externally Controlled

The master controls the power mode of the MA782 with digital input pins. Through the two digital input pins (EN and ASC), it is possible to switch between any power mode.

Power Supply

It is recommended to place a 1 μ F decoupling capacitor close to the sensor with a low impedance path to GND (see Figure 9).

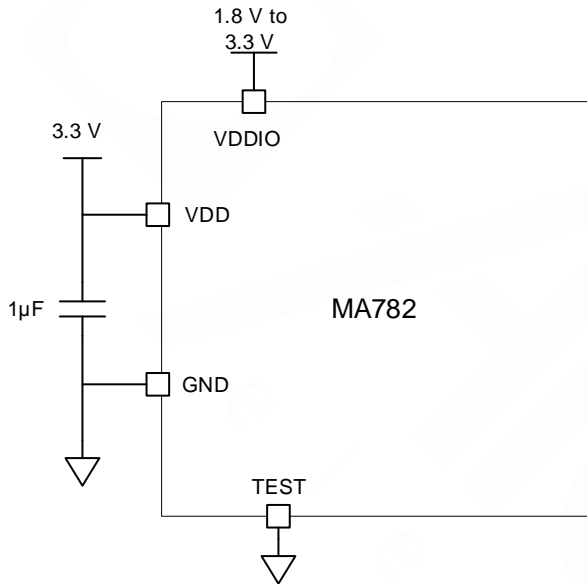

Figure 9: Electrical Mounting and Power Supply Decoupling

Power up sequence

VDD should be supplied before VDDIO. The preconfigured mode (for instance ASC) will start after CS is set to 1.

Serial Interface

The sensor supports the SPI serial interface for angle reading and register programming.

SPI

SPI is a four-wire, synchronous, serial communication interface. The MagAlpha supports SPI Mode 3 and Mode 0 (see Tables 1 and 2).

Table 1: SPI Specification

	Mode 0	Mode 3
SCLK idle state	Low	High
Data capture	On SCLK rising edge	
Data transmission	On SCLK falling edge	
CS idle state	High	
Data order	MSB first	

The SPI Mode (0 or 3) is detected automatically by the sensor and does not require additional action. The maximum clock rate supported on SPI is 25MHz. There is no minimum clock rate. Real-life data rates depend on the PCB layout quality and signal trace length. See Figure 10, Figure 11, and Table 3 for SPI timing.

Table 2: SPI Standard

	Mode 0	Mode 3
CPOL	0	1
CPHA	0	1
Data Order (DORD)	0 (MSB first)	

All commands to the MagAlpha (whether for writing or reading register content) must be transferred through the SPI MOSI pin and must be 16 bits long. See the SPI Communication section on page 13 for details.

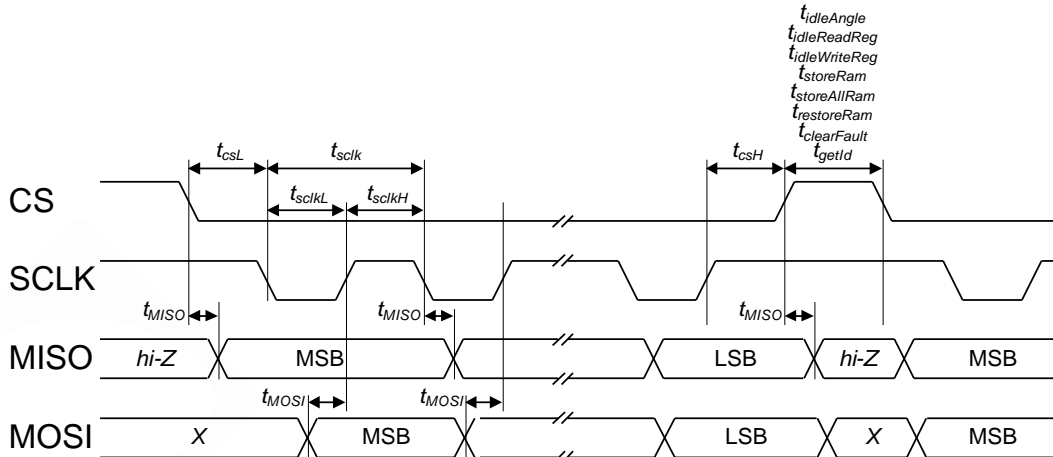
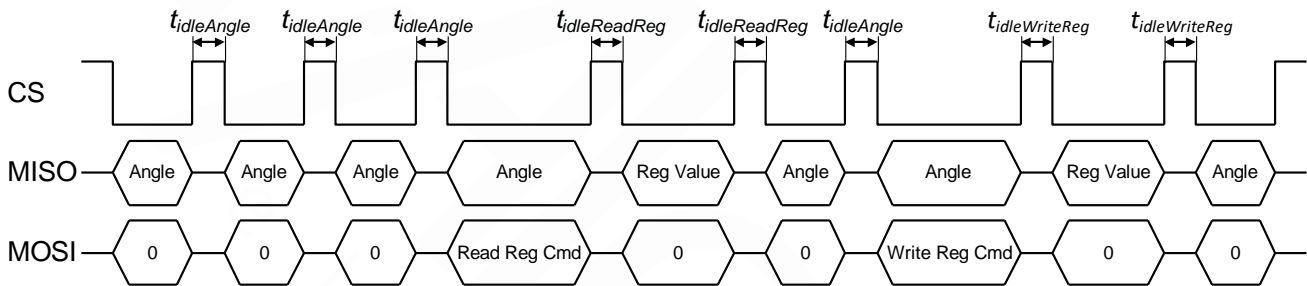
Figure 10: SPI Timing Diagram (Mode 3)

Figure 11: Minimum Idle Time
Table 3: SPI Timing

Parameter ⁽⁶⁾	Description	Min	Max	Unit
$t_{idleAngle}$	Idle time between two subsequent angle transmissions	40		ns
$t_{idleReadReg}$	Idle time before and after a register readout	40		ns
$t_{idleWriteReg}$	Idle time before and after a register write	40		ns
$t_{storeRam}$	time required to store a register value to the NVM	23		ms
$t_{storeAllRam}$	time required to store all registers values to the NVM	704		ms
$t_{restoreRam}$	time required to restore all registers values from the NVM	240		us
$t_{clearFault}$	time required to clear the fault flags (register 26)	40		ns
t_{getID}	Idle time between a get ID command and the readout of the ID value	40		ns
t_{csL}	Time between CS falling edge and SCLK falling edge	100		ns
t_{sclk}	SCLK period	40		ns
t_{sclkL}	Low level of SCLK signal	20		ns
t_{sclkH}	High level of SCLK signal	20		ns
t_{csH}	Time between SCLK rising edge and CS rising edge	20		ns
t_{MISO}	SCLK falling edge to data output valid		15	ns
t_{MOSI}	Data input valid to SCLK reading edge	15		ns

Note:

6) All values are guaranteed by design.

SPI Communication

The sensor supports three types of SPI operation: read angle, read configuration register, and write configuration register. Each operation has a specific frame structure described below.

SPI Read Angle

Every 1µs, new data is transferred into the output buffer. The master device triggers the reading by pulling CS low. When a trigger event is detected, the data remains in the output buffer until the CS signal is de-asserted (see Table 4).

Table 4: Sensor Data Timing

Event	Action
CS falling edge	Start reading and freeze output buffer
CS rising edge	Release of the output buffer

Figure 12 shows a diagram of a full SPI angle reading. Figure 13 shows a partial SPI angle reading. A full angle reading requires 16 clock pulses. The sensor MISO line returns:

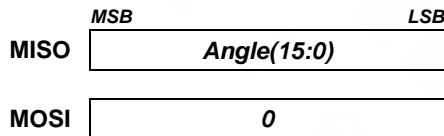

If less resolution is sufficient, the angle can be read by sending fewer clock counts, since the MSB is first (see Figure 13).

If the reading cycle is shorter than the refresh time, the MagAlpha continues sending the same data until the data refreshes (see the refresh rate in the General Characteristics).

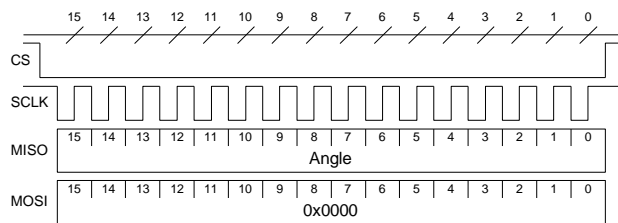

Figure 12: Diagram of a Full 16-Bit SPI Angle Reading

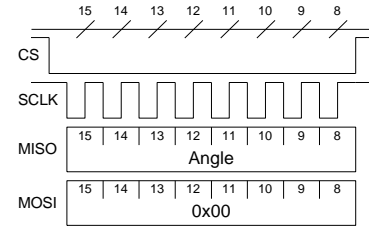
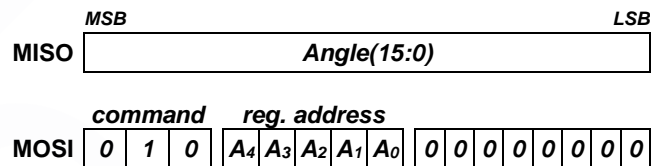

Figure 13: Diagram of a Partial 8-Bit SPI Angle Reading

SPI Read Register

A read register operation is constituted of two 16-bit frames. The first frame sends a read request, which contains the 3-bit read command (010) followed by the 5-bit register address. The last 8 bits of the frame must be all set to 0. The second frame returns the 8-bit register value (MSB byte) with a 8-bit angle value.

First 16-bit SPI frame (read request):



Second 16-bit SPI frame (response):

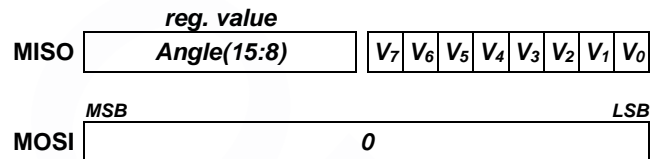

See Figure 14 for a complete transmission.

For example, to get the value of the magnetic level high and low flags (MGH and MGL), read register 27 (bit 6, bit 7) by sending the following first frame:

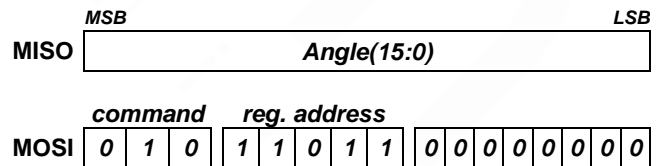

In the second frame, the MagAlpha replies:

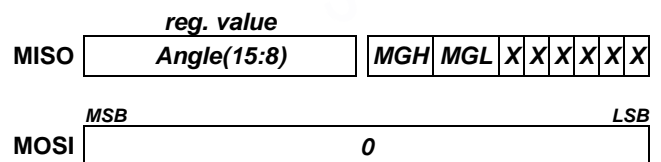

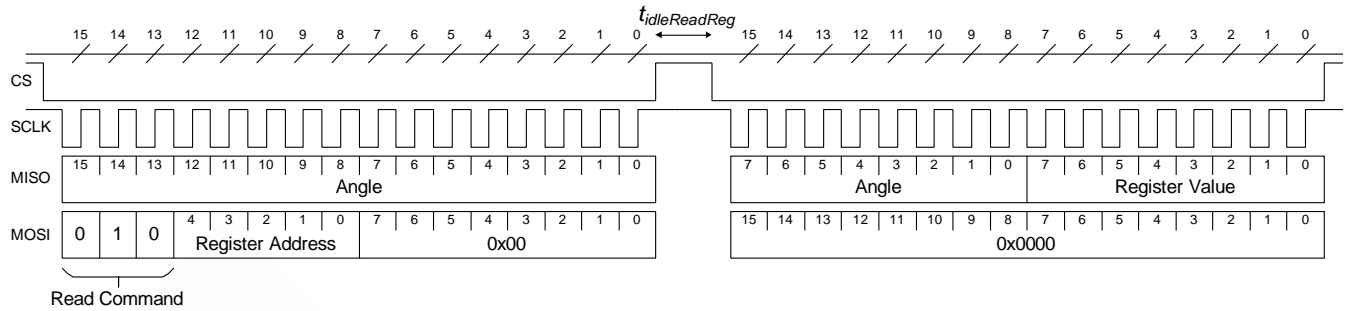
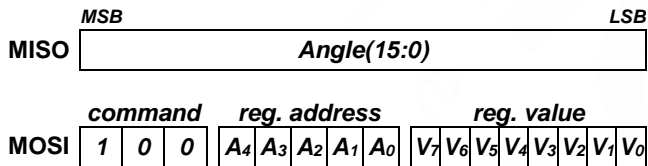

Figure 14: Two 16-Bit Frames Read Register Operation

SPI Write Register

A write register operation is constituted of two 16-bit frames. The first frame sends a write request, which contains the 3-bit write command (100) followed by the 5-bit register address and the 8-bit value (MSB first). The second frame returns the newly written register value (acknowledge) with a 8-bit angle value.

The first 16-bit SPI frame (write request) is:



The second 16-bit SPI frame (response) is:

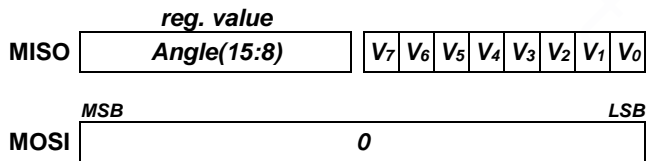

The read-back register content can be used to verify the register programming. Figure 16 shows a complete transmission.

For example, to set the value of the output rotation direction (RD) to counterclockwise (RD bit = 1), write register 9 by sending the following first frame:

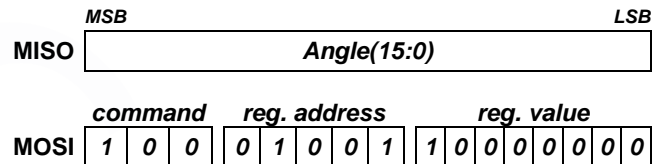

Send the second frame. If the register is written correctly, the reply is:

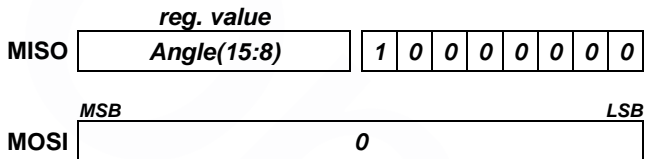

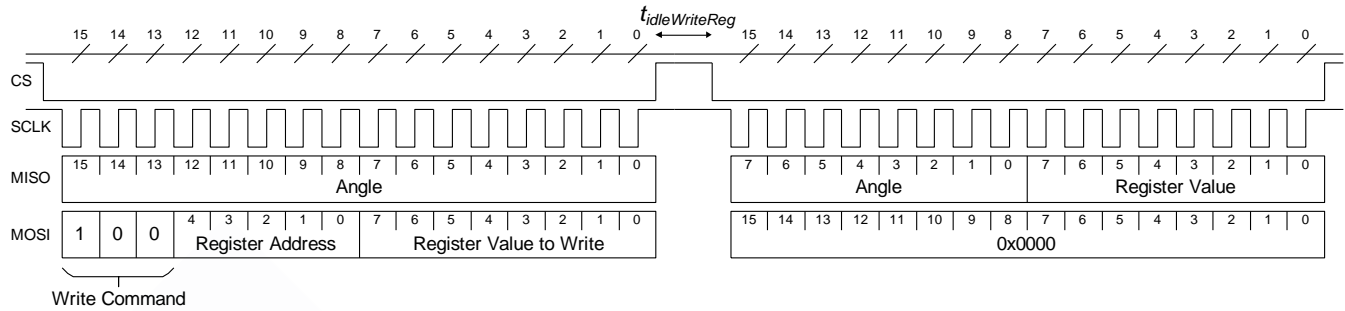

Figure 16: Overview of a Write Register Operation with Two 16-Bit Frames

NVM Operations

The sensor contains a non-volatile memory (NVM) to store the chip configuration during power-down. The values stored in the NVM are automatically loaded into the sensor's registers at power-up time. It is possible to manually force the restore of the NVM values to the registers by using the Restore All Register Values SPI command (see section below).

The registers can be copied to the NVM using two SPI commands:

1. Store a single Register Value to NVM
2. Store All Register Values to NVM

The desired configuration must first be written to the RAM registers through the read/write register commands (see previous SPI sections), and then one of the store commands can save one or all registers to the NVM.

These commands are ignored if the NVM is busy executing a previously received command. To check that the NVM is available and ready to receive a new command, observe the NVM pin level.

The NVM pin is set to high when the non-volatile memory is busy. Store and restore commands are only processed when the NVM pin is cleared low (see Figure 18).

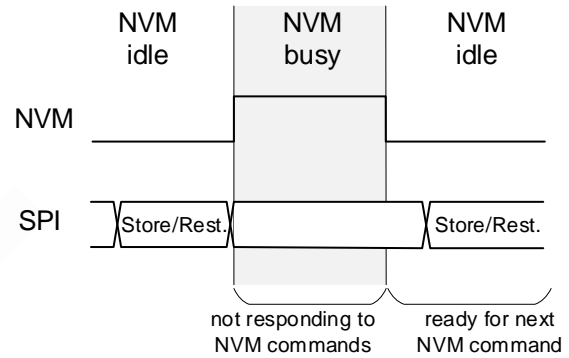

Figure 18: Signal Timing for NVM Access

SPI Store a Single Register to NVM

The current value of a specific register can be stored in the non-volatile memory. This command will be ignored if the NVM is busy executing a previously received command (see NVM Operation).

SPI Store All Registers to NVM

Store the current value of all registers in the Non Volatile Memory. This command is ignored if the NVM is busy executing a previously received.

SPI Restore All Registers from NVM

Restore the value of all registers from NVM. This operation is done automatically at each power up.).

This command is ignored if the NVM is busy executing a previously received.

SPI Clear Error Flags

Clear the error flags in register 26.

Table 5 shows a summary of all SPI commands.

Table 5: SPI Command List Overview

Command Function	Command bits [15:13]	Register Address Required	Register Value Required	Returned Value
Read Angle	000	No	No	16-bit Angle
Read Register	010	Yes	No	8-bit Angle + Register Value
Write Register	100	Yes	Yes	8-bit Angle + Register Value
Store Single Register to NVM	111	Yes	No	16-bit Angle
Store All Registers to NVM	110	No	No	16-bit Angle
Restore All Registers from NVM	101	No	No	16-bit Angle
Clear Error Flags	001	No	No	16-bit Angle

REGISTER MAP

Please refer also to the complete MA782 register map in Appendix C

Table 6: Register Map

No	Hex	Bin	Bit 7 MSB	Bit 6	Bit 5	Bit 4	Bit 3	Bit 2	Bit 1	Bit 0 LSB	
0	0x0	00000	Z(7:0)								
1	0x1	00001	Z(15:8)								
2	0x2	00010	BCT(7:0)								
3	0x3	00011	-	-	-	-	-	-	ETY	ETX	
4	0x4	00100	TCYC(7:0)								
5	0x5	00101	TCYC(15:8)								
6	0x6	00110	MGLT(2:0)			MGHT(2:0)			-	MG	
7	0x7	00111	NDM	RAR	HYST(5:0)						
8	0x8	01000	THR(7:0)								
9	0x9	01001	RD	-	-	-	-	-	-	-	
10	0xA	01010	REF(7:0)								
11	0xB	01011	ASCR	ASC	-	-	-	-	-	-	
14	0xE	01110	FW(3:0)								
26	0x1A	11010	-	-	-	-	ERRPAR	ERRMEM	ERRCRC	-	
27	0x1B	11011	MGH	MGL	-	-	-	-	-	-	

Table 7: Factory Default Values

No	Hex	Bin	Bit 7 MSB	Bit 6	Bit 5	Bit 4	Bit 3	Bit 2	Bit 1	Bit 0 LSB
0	0x0	00000	0	0	0	0	0	0	0	0
1	0x1	00001	0	0	0	0	0	0	0	0
2	0x2	00010	0	0	0	0	0	0	0	0
3	0x3	00011	0	0	0	0	0	0	0	0
4	0x4	00100	0	1	1	0	1	1	1	0
5	0x5	00101	0	0	0	0	0	0	0	0
6	0x6	00110	0	0	0	1	1	1	0	1
7	0x7	00111	0	0	0	0	0	0	0	0
8	0x8	01000	0	0	0	0	0	0	0	0
9	0x9	01001	0	0	0	0	0	0	0	0
10	0xA	01010	0	0	0	0	0	0	0	0
11	0xB	01011	1	1	0	0	0	0	0	0
14	0xE	01110	1	0	0	1	0	0	0	0

Table 8: Programming Parameters

Parameters	Symbol	Number of Bits	Description	See
Zero Setting	Z	16	Sets the zero position.	Table 9
Bias Current Trimming	BCT	8	For side-shaft configuration: reduces the bias current of the X or Y Hall device.	Table 11
Enable Trimming X	ETX	1	Biased current trimmed in the X direction Hall device.	Table 12
Enable Trimming Y	ETY	1	Biased current trimmed in the Y direction Hall device.	Table 12
Cycle Time	TCYC	16	ASC mode: time for an active + idle cycle.	Table 18
Magnetic Field Low Threshold	MGLT	3	Sets the field strength low threshold.	Table 14
Magnetic Field High Threshold	MGHT	3	Sets the field strength high threshold.	Table 14
Magnetic Field Strength	MG	1	Enables the field strength detection.	Table 13
Threshold	THR	8	ASC mode: threshold for change detection.	Table 21
ND Mode	NDM	1	ND pin logic or latched mode	Table 22
ND pin Hysteresis	HYST	6	Determines hysteresis applied to ND pin.	Table 23
Rotation Direction	RD	1	Determines the sensor positive direction.	Table 10
Reference	REF	8	ASC mode: Angle of reference for detection of change	Table 21
Reference Auto Refresh	RAR	1	ASC mode: automatically updates the reference at each detection change.	Table 22
Auto Sampling Cycle	ASC	1	Enables the ASC mode.	Table 16
ASC Register driven	ASCR	1	Allows the enabling of the ASC mode via register settings.	Table 16
Filter Window	FW	4	Size of the filter window. Determines the resolution	Table 15

REGISTER SETTINGS

Zero Setting

The zero position of the MagAlpha (a_0) can be programmed with 16 bits of resolution. The angle streamed out by the MagAlpha (a_{out}) is given by Equation (2):

$$a_{out} = a_{raw} - a_0 \quad (2)$$

Where a_{raw} is the raw angle provided by the MagAlpha front end.

The parameter Z(15:0), is the zero angle position coded on 16 bit. See Table 9.

Table 9: Zero Setting Parameter

Z(15:0)	Zero pos. a_0 (deg)
0	0
1	0.005
2	0.011
...	...
65534	359.989
65535	359.995

Rotation Direction

By default, when looking at the top of the package, the angle increases when the magnetic field rotates clockwise (CW) (see Figure 24 and Table 10).

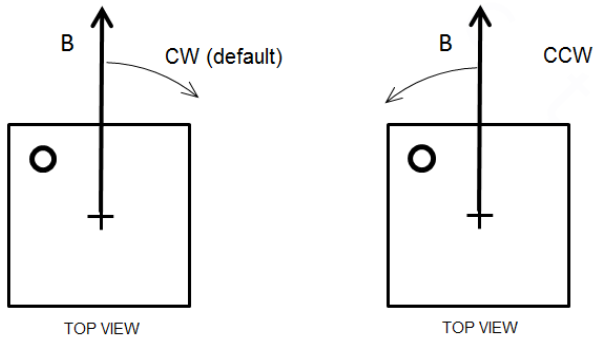

Figure 24: Positive Rotation Direction of the Magnetic Field

Table 10: Rotation Direction Parameter

RD	Positive Direction
0	Clockwise (CW)
1	Counterclockwise (CCW)

BCT Settings (Bias Current Trimming)

Side Shaft

When the MA782 is mounted on the side of the magnet, the relation between the field angle and

the mechanical angle is no longer directly linear. This effect is related to the fact that the tangential magnetic field is usually smaller than the radial field. Define the field ratio k with Equation (3):

$$k = B_{rad}/B_{tan} \quad (3)$$

Where B_{rad} and B_{tan} are the maximum radial and tangential magnetic fields (see Figure 25).

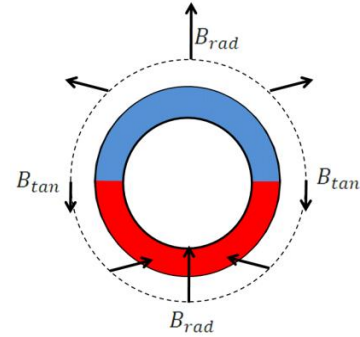

Figure 25: Side-Shaft Field

The ratio k depends on the magnet geometry and the distance to the sensor (see Figure 33). Having a k ratio different from 1 results in the sensor output response not being linear with respect to the mechanical angle. The error curve has the shape of a double sinewave (see Figure 27). E is the amplitude of this error.

The X-axis or the Y-axis bias current can be reduced in order to recover an equal Hall signal for all angles and therefore suppress the error. The parameters ETX and ETY control the direction in which sensitivity is reduced. The current reduction is set by the parameter bias current trimming BCT(7:0), which is an integer from 0 to 255.

In side-shaft configuration (when the sensor center is located beyond the magnet outer diameter), k is greater than 1 if k is known set using Equation (4):

$$BCT(7:0) = 258 \left(1 - \frac{1}{k}\right) \quad (4)$$

Figure 26 shows the optimum BCT value for a particular k ratio.

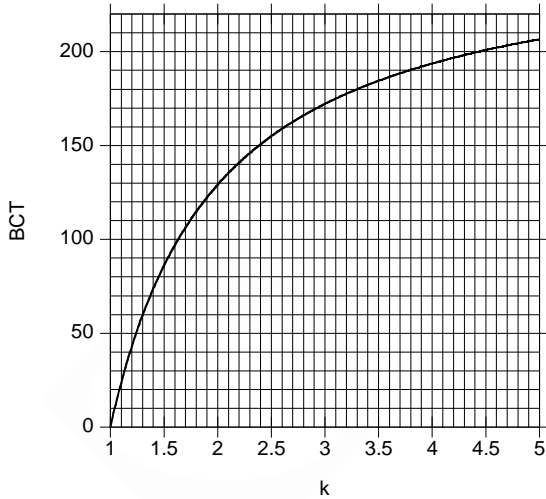

Figure 26: Relation between the *k* Ratio and the Optimum BCT to Recover Linearity

Table 11 shows typical BCT values.

Table 11: Example of BCT Settings

E (deg)	Magnet Ratio <i>k</i>	BCT(7:0)
0	1.0	0
11.5	1.5	86
19.5	2.0	129
25.4	2.5	155
30.0	3.0	172
33.7	3.5	184
36.9	4.0	194
39.5	4.5	201
41.8	5.0	207

Determining *k* with the MagAlpha

It is possible to deduce the *k* ratio from the error curve obtained with the default BCT setting (BCT = 0). To do this, rotate the magnet over one revolution and record the MagAlpha output. Then plot the error curve (the MagAlpha output minus the real mechanical position vs the real mechanical position) and extract two parameters: the maximum error *E*, and the position of this maximum with respect to a zero crossing α_m (see Figure 27). *k* can be calculated with Equation (5):

$$k = \frac{\tan(E + \alpha_m)}{\tan(\alpha_m)} \quad (5)$$

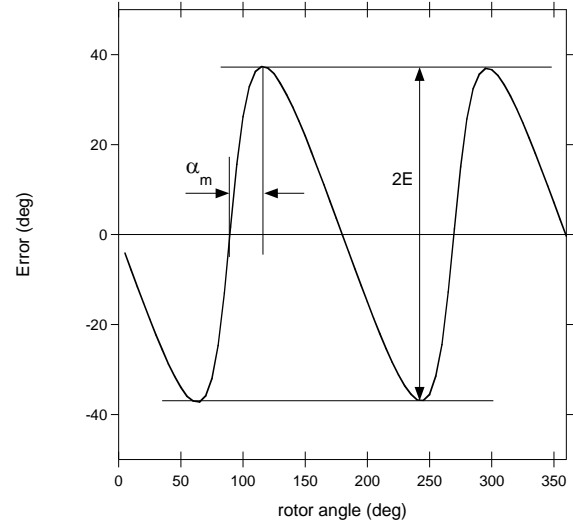

Figure 27: Error Curve in Side-Shaft Configuration with BCT = 0

Alternatively, the *k* parameter can be obtained from Figure 28.

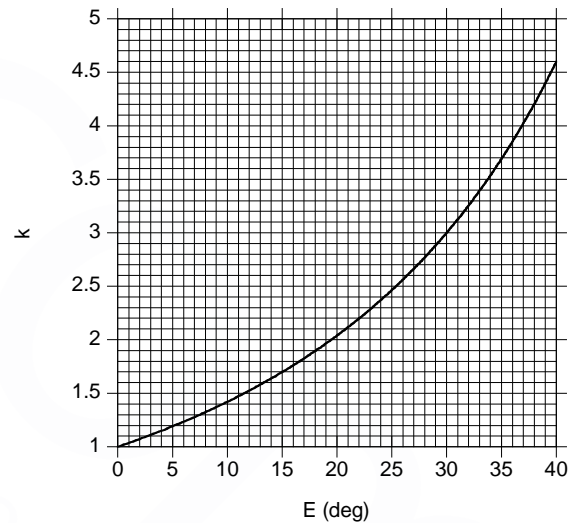

Figure 28: Relationship between the Error Measured with BCT = 0 and the Magnet Ratio *k*

Sensor Orientation

From the dot marked on the package, it is possible to know whether the radial field is aligned with the sensor coordinates X or Y (see Figure 29).

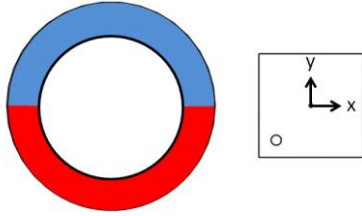

Figure 29: Package Top View with X and Y Axes

Determine which axis needs to be reduced (see the qualitative field distribution around a ring in Figure 25). For instance, with the arrangement depicted in Figure 29, the field along the sensor Y direction is tangential and weaker. The X-axis should be reduced (ETX = 1 and ETY = 0). If both ETX and ETY are set to 1, the current bias is reduced in both directions the same way, without side-shaft correction (see Table 12). This reduces the sinusoidal signal shown in figure 2 and, consequently modifies the magnetic field thresholds.

Table 12: Trimming Direction Parameters

ETX	Enable Trimming of the X-Axis
0	Disables
1	Enables
ETY	Enable Trimming of the Y-Axis
0	Disables
1	Enables

Magnetic Field Thresholds

The magnetic flags indicate that the magnetic field at the sensor position is out a range defined by the lower (MGLT) and upper magnetic field thresholds (MGHT). Figure 30 shows this relationship.

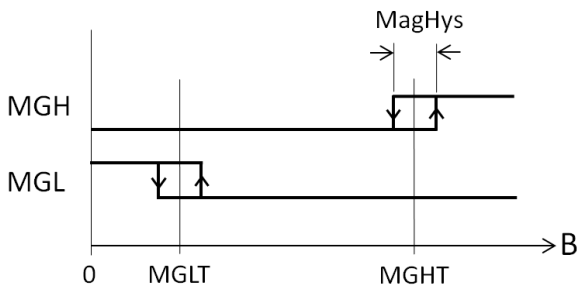

Figure 30: MGH and MGL Signals as a Function of the Field Strength

To enable the magnetic field strength measurements the parameter MG must be set to logic1 (see Table 13).

Table 13: Magnetic Field Strength

MG	Field Strength Measurement
0	Disabled
1	Enabled

MagHys, the typical hysteresis on the signals MGH and MGL is 6mT. The MGLT and MGHT thresholds are coded on three bits and stored in register 6.

Register 6

Register 6							
Bit 7	Bit 6	Bit 5	Bit 4	Bit 3	Bit 2	Bit 1	Bit 0
MGLT			MGHT			-	-

The 3-bit values of MGLT and MGHT correspond to the magnetic field (see Table 14).

Table 14: MGLT and MGHT: Binary to mT Relation

MGLT or MGHT ⁽⁸⁾	Field threshold in mT ⁽⁷⁾	
	From low to high magnetic field	From high to low magnetic field
000	26	20
001	41	35
010	56	50
011	70	64
100	84	78
101	98	92
110	112	106
111	126	120

Notes:

- 7) Valid for VDD = 3.3V. If different from field threshold, scale by the factor VDD/3.3V. When ETX = 1 and ETY = 1, it is possible to increase the field thresholds by increasing BCT.
- 8) MGLT can have a larger value than MGHT.

The alarm flags MGL and MGH are available to be read in register 27 (bit 6, bit 7), and the logic state of MGL is also given at the digital output pin 2.

To retrieve the MGL and MGH flags by SPI send the 8-bit command read for register 27:

command	reg. address	MSB	value	LSB
0 1 0	1 1 0 1 1	0	0 0 0 0 0 0 0 0	0

The MA782 answers with the register 27 content in the next transmission:

R[7:0]							
MGL	MGL	x	x	x	x	x	x

Status byte

Register 26 contains information about the sensor's operational integrity.

ERRPAR

When using 17 bit communication on the SPI bus the SPI write register command sent by the controller to the MA782 can be checked for parity (not the other commands). For this the controller shall send, on the MISO line, a parity bit after the 16 bit command. The MA782 checks the parity of the 17 bit long word. In the case of parity error the data supposed to be written to RAM is discarded and the ERRPAR bit is asserted (set to '1').

ERRMEM

The NVM pin indicates that NVM is busy. Should a command trigger an NVM access (read or write) in this period, it is ignored and the ERRMEM bit is asserted (set to '1').

ERRCRC

The restoring of register values from NVM is secured by a CRC algorithm. A mismatch between the generated CRC result with the previously stored value is flagged by the ERRCRC bit being asserted (set to '1').

The status byte can be cleared by sending the SPI Clear Error Flags command.

Filter Window size

The filter window determines the effective resolution (defined as the $\pm 3\sigma$ noise interval). The contour plot in Figure 31 represents the effective resolution for different window size FW and magnetic field B.

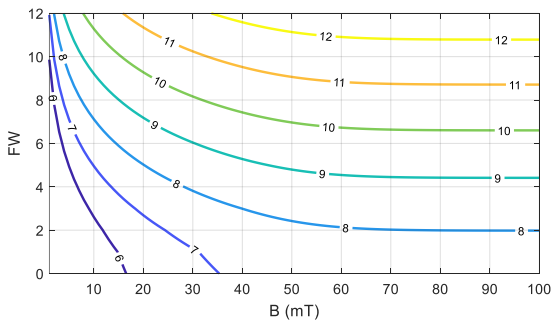

Figure 31: MA782 Resolution

Since FW modifies the filter time constant τ , it has an impact on the output bandwidth. The

upper limit of the bandwidth, the cutoff frequency F_{CUTOFF} , is related to τ through eq. (6):

$$F_{CUTOFF} = \frac{1}{2\pi\tau} \tag{6}$$

Table 15 shows the time constant for each window.

Table 15: Filter window size

Window Size FW(3:0)	Time Constant τ (μ s)	Filter Settling Time (μ s)
0	1	1
1	2	3
2	4	7
3	8	15
4	16	31
5	32	63
6	64	127
7	128	255
8	256	511
9	512	1023
10	1024	2047
11	2048	4095
12	4096	8191
13	4096	8191
14	4096	8191
15	4096	8191

Note: Refer to EC table for the filter settling time accuracy.

Each time the MA782 enters the Active mode (whether it is externally controlled or in ASC mode), the filter window has to fill up. Therefore the angle output is not stable until a certain amount of time is passed, called the filter settling time. This time is indicated by the raise of the data valid flag (DV output pin). Table 15 gives the settling time for each window size.

Latency

The latency is the difference between the true position of the mechanical angle and the angle reading available on the SPI interface. It is a function of the filter time constant τ . Assuming a continuous active mode, the latency at constant rotation speed is $\tau + 3 \mu$ s.

LOW POWER OPERATION

See section “The different power modes” for an explication of the modes available: **active, idle or ASC**. Table 16 shows how to select the power modes.

Table 16: Power State

EN (pin)	ASC (pin)	ASC (reg.)	ASCR (reg.)	Mode
0	0	X	0	Idle
0	1	X	0	ASC
0	X	0	1	Idle
0	X	1	1	ASC
1	X	X	X	Active

Note: "X" means any state.

See Table 17 for examples of settings.

Table 17. Typical Setting for mixed operation

Modes	Pin used for switching	Example of Preset
ASC only	None	EN = 0 ASCR = 1 ASC(reg.) = 0
Active-Idle	EN	ASCR = 1 ASC(reg.) = 0
Active-ASC	EN	ASCR=1 ASC(reg.) = 0
ASC-Idle	ASC	EN = 0 ASCR = 0

Externally Switching Between Active and Idle Modes

Pulling the EN pin high activates the MA782. After the filter settling time, the DV signal indicates that the measurement is stable. The master can send the MA782 back to idle while the angle remains in the MA782 output buffer and the SPI interface remains active to allow data reading (see Figures 32 and 33).

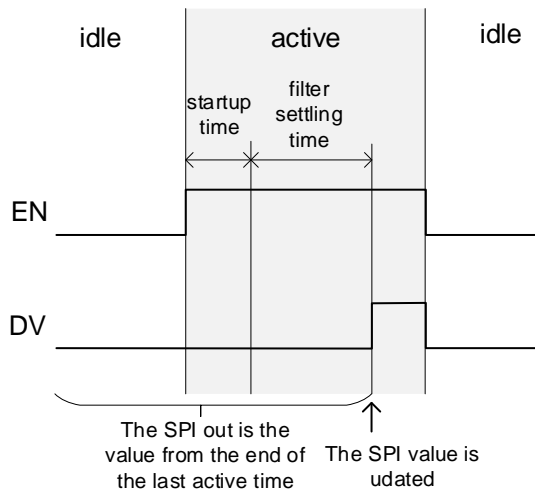

Figure 32: Signal Timing for External Control

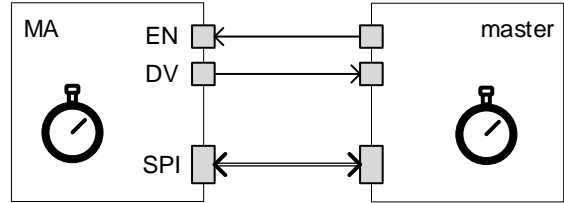

Figure 33: Typical Configuration for Switching Between the Active and Idle Modes

Mixed Operation – Active and ASC

It is possible to switch between a low-power ASC mode and a high power Active mode by driving the EN pin high or low respectively. It allows making high-rate, full power measurements for instance after a certain angle change was detected while in ASC mode.

Mixed Operation - ASC and Idle

In this scenario the mode is switched by driving the ASC state by pin or register. ASC is activated when ASC is high. In this configuration the angle is updated when in ASC mode. See Fig 15.

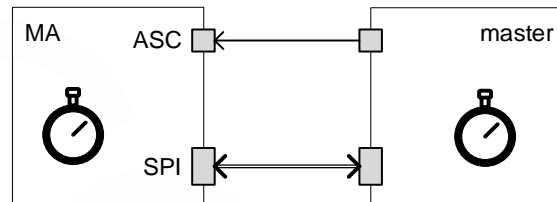

Figure 34: Typical Configuration to Switch between ASC and Idles Modes using the ASC pin

Configuration of the ASC mode

The power cycles are defined by the active time and the cycle time. The active time is automatically adjusted according to the filter window, in such way that the active time ends when the filer has settled. The active time t_{active} is therefore:

$$t_{active} = t_{startup} + t_{settling}$$

Where $t_{settling}$ is the settling time given in table 15.

Figure 35 shows an ASC cycle.

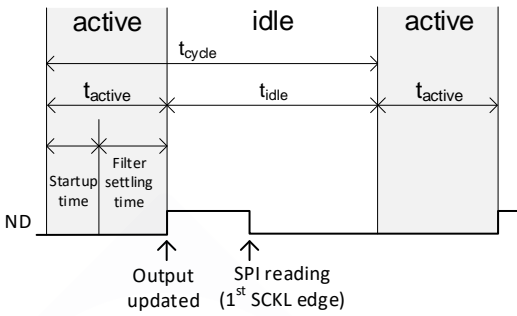

Figure 35: Timing of a ASC Cycle

Note that the master device can read the sensor angle at any time.

TCYC, on the other hand, is directly programmed by the user. The cycle time must be larger than the Active time (see Table 20). Otherwise the cycle time increases by an integer number of times until it is larger than t_{active} .

Table 18: Cycle Time

TCYC	Cycle time (ms)
0	Continuously idle
1	Do not use
2	0.2
3	0.3
4	0.4
...	...
65535	6553.5

Refer to EC table for the Cycle time accuracy.

Once the time t_{active} and the parameter TCYC are set, the average current consumption is obtained by:

$$i = i_{active} \frac{t_{active}}{t_{cycle}} + i_{idle} \left(1 - \frac{t_{active}}{t_{cycle}}\right)$$

New Data (ND) pin

The New Data (ND) signal has different use cases depending on the low power mode. ND can indicate the end of an active period or detects a predefined motion.

By default, the ND signal rises after each active phase and latches to indicate that a new value is available in the output buffer. ND resets after reading the angle as shown on the waveform of Figure 36. This default state occurs when NDM=0 and THR=0.

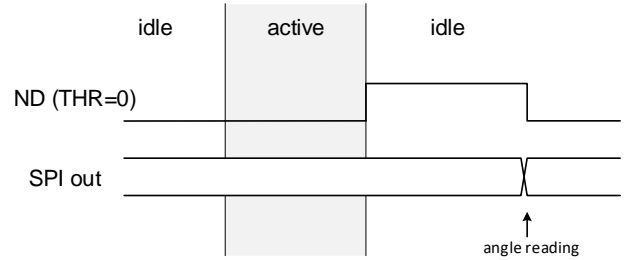

Figure 36: Using the ND Pin in Latch Mode as a Flag for Data Updates (NDM=0, THR = 0)

Figure 37 shows the simplest connection to use this feature of the ND pin.

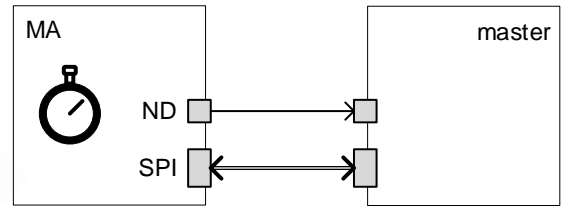

Figure 37: Reading both SPI and ND

Threshold

If the threshold parameter is programmed to a non-zero value, the ND pin becomes a “Warning On Change” signal (WOC). See Figure 38.

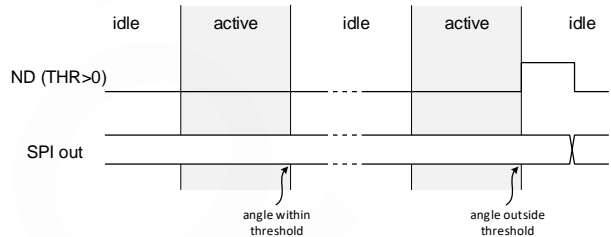

Figure 38: ND Pin Used at WOC Signal with a Non-Zero Threshold Setting (Latch Mode)

The THR parameter is a relative angle coded on 8 bit (see Table 19). If THR is greater than 180, the lower and upper threshold are merging and therefore the range of angle located “beyond threshold” disappears, which effectively disables the ND flag.

Table 19: Threshold for Wake-Up

THR(6:0)	Threshold (deg)
0	0
1	1.41
2	2.81
...	...
127	178.59
128	180 (ND flag only at 180)
129	181.41 (no ND flag)
...	...
255	358.59 (no ND flag)

Reference

The change is defined in relationship to a reference angle. This angle is controlled by the parameter REF. The ND pin goes high whenever the angle distance to REF gets larger than the threshold.

REF is an absolute angle coded on 8 bits (see Table 20).

Table 20: Change Detection Fixed Reference

REF(7:0)	Reference (deg)
0	0
1	1.41
2	2.81
...	...
255	358.59

REF can either be a fixed value, or can be automatically updated at each crossing of the threshold, to detect an increment rather than a crossing of an absolute position. Use the Reference Auto Refresh bit (RAR) to select between these two kinds of references. See Table 21.

Table 21: Wake-Up on Change Mode

RAR	Reference
0	Remains fixed
1	Updates

IF RAR = 0 (fixed at reference position), the ND pin goes high whenever the angle lies beyond the fixed threshold (see Figure 39).

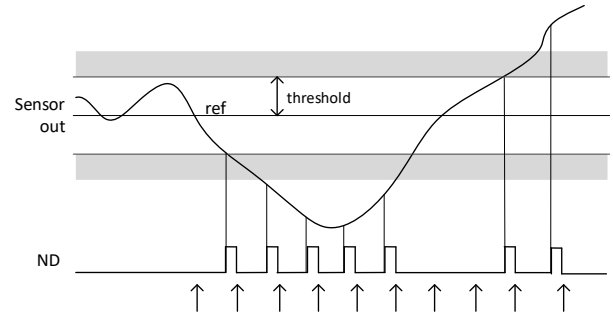

Figure 39: Example of ND signal when the Angle is Changing. Arrows indicate SPI readings.

IF RAR = 1, REF is automatically updated each time the threshold is crossed (see Figure 40). It means that the user value is lost and the new value of REF is the sensor output value at the moment threshold was crossed.

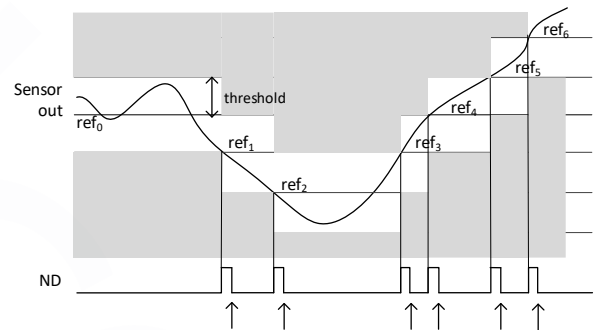

Figure 40: RAR = 1 - Example of ND Signal when the Angle is Changing. Arrows indicate SPI readings.

ND Mode (NDM)

By default the ND flag is reset by an SPI reading. This is the LATCH mode. In some cases the user might want to detect an absolute threshold (RAR=0) without being forced to reset the ND state by SPI. For this purpose the ND pin can be set LOGIC LEVEL instead of LATCH mode using the NDM bit in register 7 (see Table 22).

Table 22: ND Pin Mode Parameter

NDM	Mode
0 (default)	Latched
1	Logic Level

In LATCH mode the ND pin is reset on the first SCLK rising edge of some SPI commands: read angle, store registers to NVM, restore registers from NVM, and clear status byte. The ND flag is not reset by writing or reading the registers.

In LOGIC LEVEL mode the ND signal is updated every 1us, therefore reflects in real time the status of the condition (i.e. the relationship between angle output value, angle threshold, and angle reference). See Figure 41.

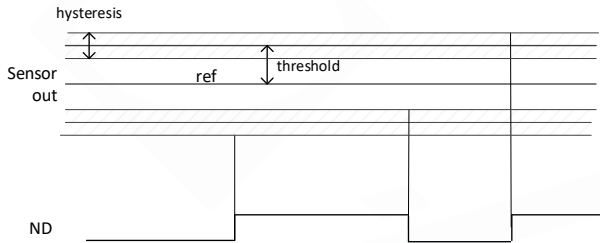

Figure 41: ND signal in Logic Level Mode when Hysteresis is Applied

In this mode, the ND signal status is not reset when SPI reads the angle. To avoid repeated ND pin transitions around the threshold it is possible to program an amount of hysteresis via the parameter HYST(5:0) in register 7:

$$\text{hysteresis} = \frac{11.25^\circ}{64} \text{HYST}(5:0)$$

HYST(5,0) is 0 by default. See Table 23 below.

Table 23: ND Pin Hysteresis Setting

HYST (5:0)	HYST (deg)
000000	0
...	...
111111	11.07

CAUTION: the HYS(5:0) affects the hysteresis of the ND pin whether NDM is 0 or 1. Therefore in LATCH mode (NDM=0), it is recommended to keep HYST=0.

Note: with RAR=1 and NDM=1, the ND pin is reset immediately after being set, generating a short pulse.

PACKAGE INFORMATION

QFN-14 (2mmx2mm)

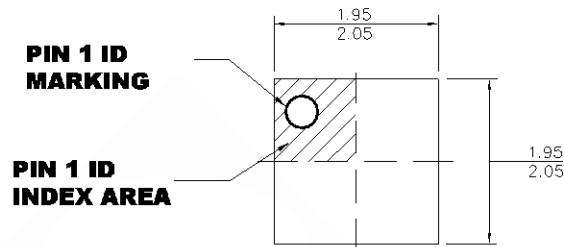

TOP VIEW

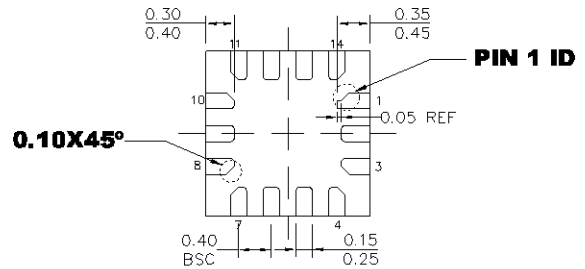

BOTTOM VIEW

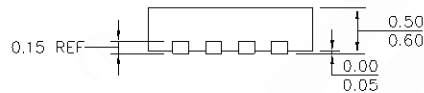

SIDE VIEW

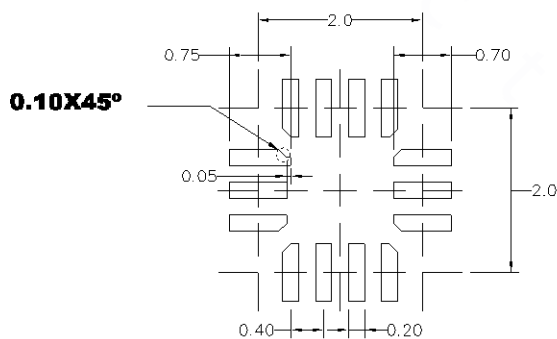

RECOMMENDED LAND PATTERN

NOTE:

- 1) ALL DIMENSIONS ARE IN MILLIMETERS.
- 2) LEAD COPLANARITY SHALL BE 0.08 MILLIMETERS MAX.
- 3) JEDEC REFERENCE IS MO-220.
- 4) DRAWING IS NOT TO SCALE.

APPENDIX A: DEFINITIONS

Effective Resolution (3σ noise level)	This is the smallest angle increment distinguishable from the noise. The resolution is measured by computing three times σ (the standard deviation in degrees) taken over 1,000 data points at a constant position. The resolution in bits is obtained with: $\log_2(360/6\sigma)$.
Refresh Rate	Rate at which new data points are stored in the output buffer.
Latency	The time elapsed between the instant when the data is ready to be read and the instant at which the shaft passes that position. The lag in degrees is $lag = latency \cdot v$, where v is the angular velocity in deg/s.
Power-Up Time	Time until the sensor delivers valid data starting at power up, i.e when the voltage supply is established.
Startup Time	Time until the sensor front-end delivers valid to the digital treatment block when recovering from idle.
Filter settling time	Time for the filter to deliver a stable angle, i.e. when the error is smaller than the noise at the particular filter window setting.
Integral Non-Linearity (INL)	Maximum deviation between the average sensor output (at a fixed position) and the true mechanical angle.

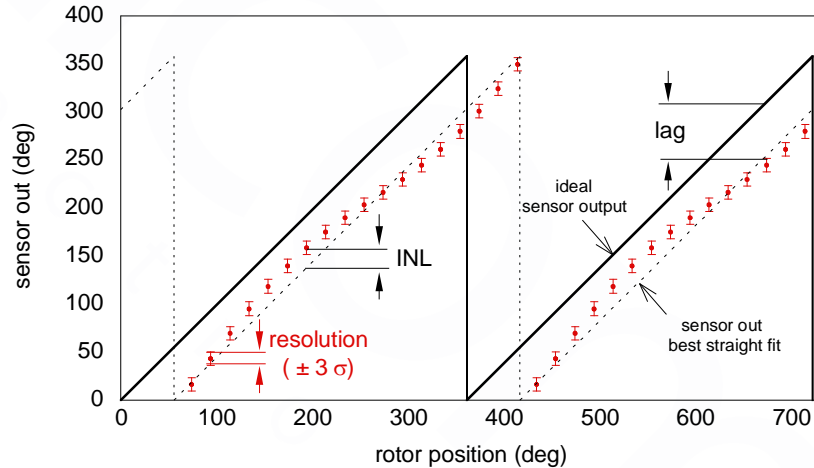

Figure A1: Resolution, INL, Lag

INL can be obtained from the error curve $err(\alpha) = out(\alpha) - \alpha$, where $out(\alpha)$ is the average over 1000 sensor output and α is the mechanical angle indicated by a high precision encoder (<0.001 deg). INL is then computed with Equation (A1):

$$INL = \frac{\max(err(\alpha)) - \min(err(\alpha))}{2} \tag{A1}$$

Drift Angle variation rate when one parameter is changed (e.g.: temperature, VDD) and all the others, including the shaft angle, are maintained constant.

APPENDIX B: SPI COMMUNICATION CHEATSHEET

Read Angle (refer to section SPI Read Angle)

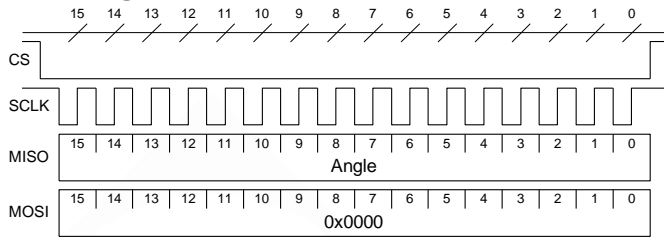

Read Register (refer to section SPI Read Register)

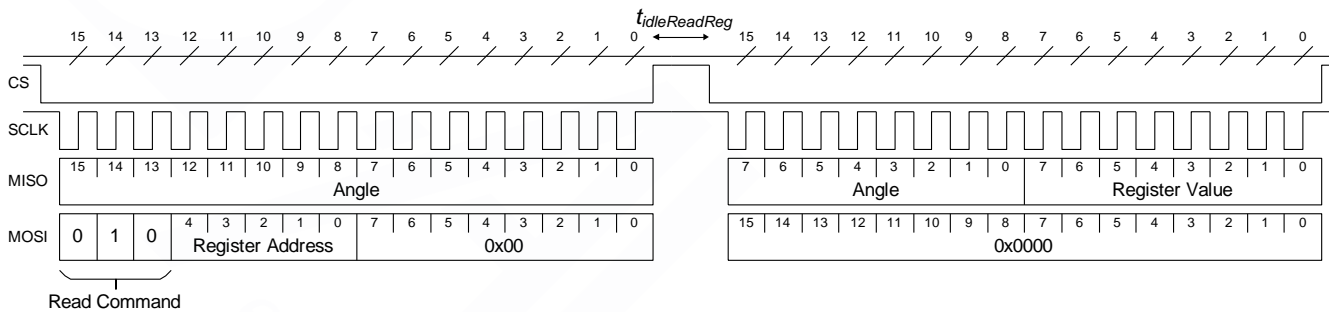

Write Register (refer to section Error! Not a valid result for table.)

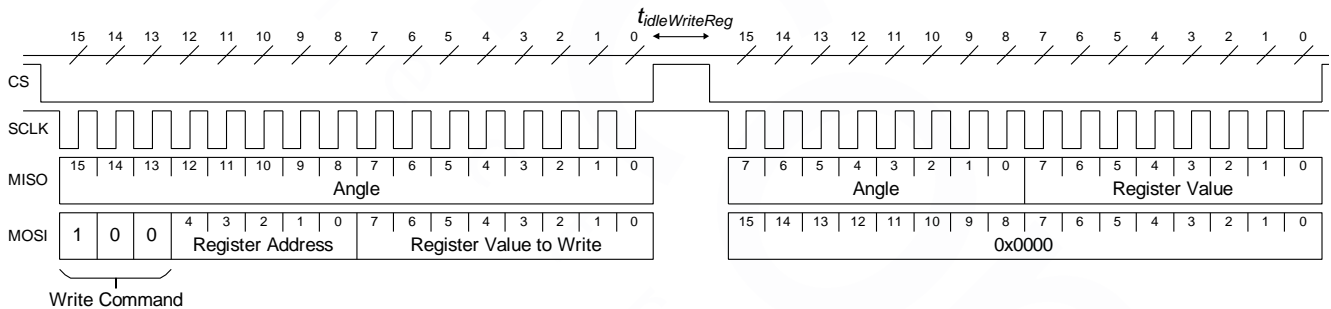

Store a Single Register Value to NVM (refer to section SPI Store a Single Register to NVM)

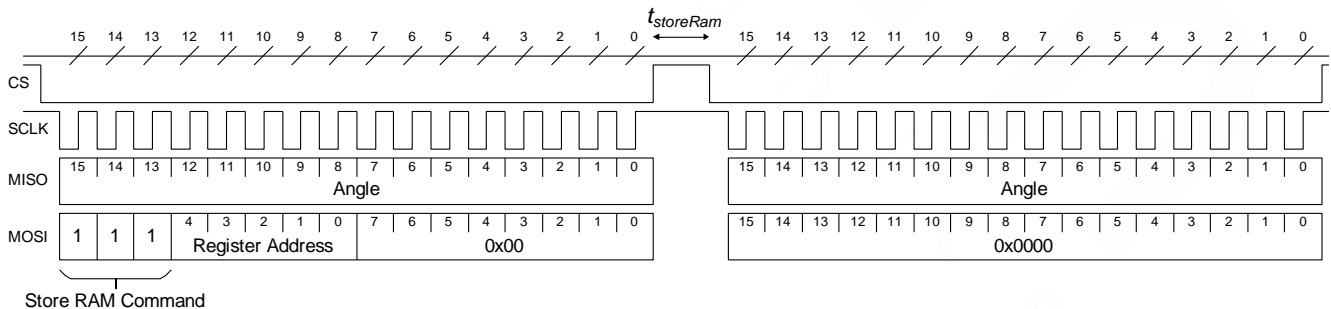

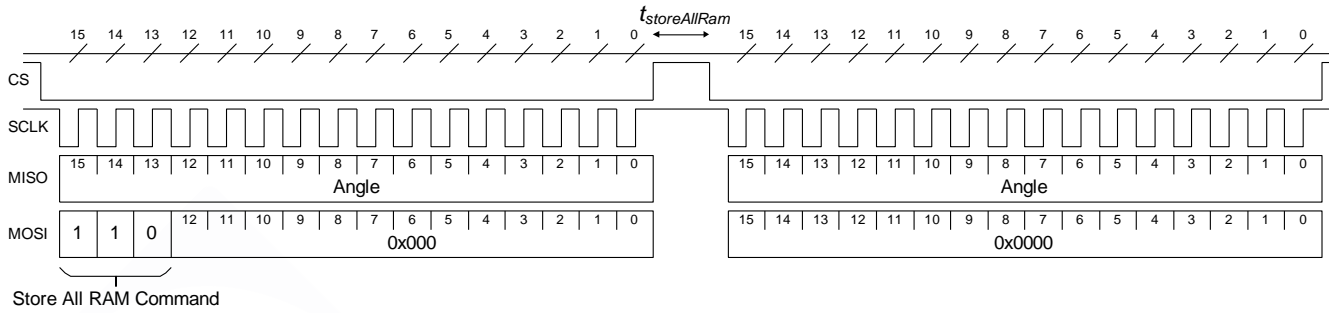
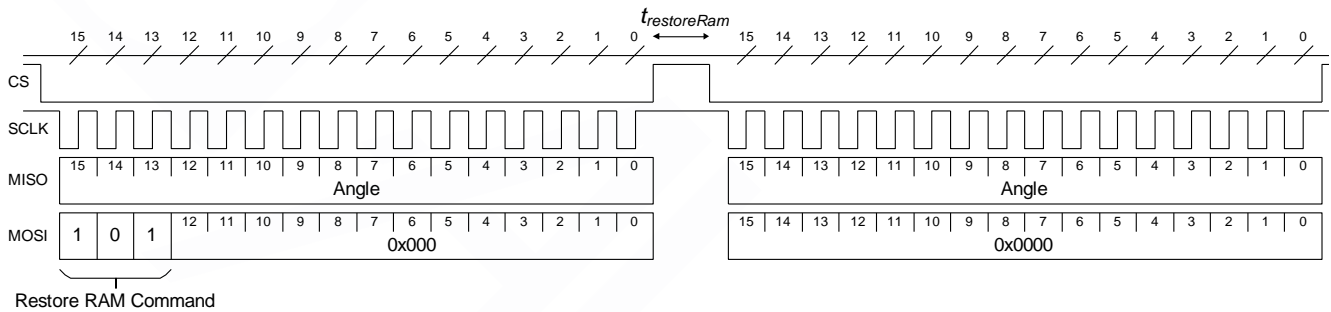
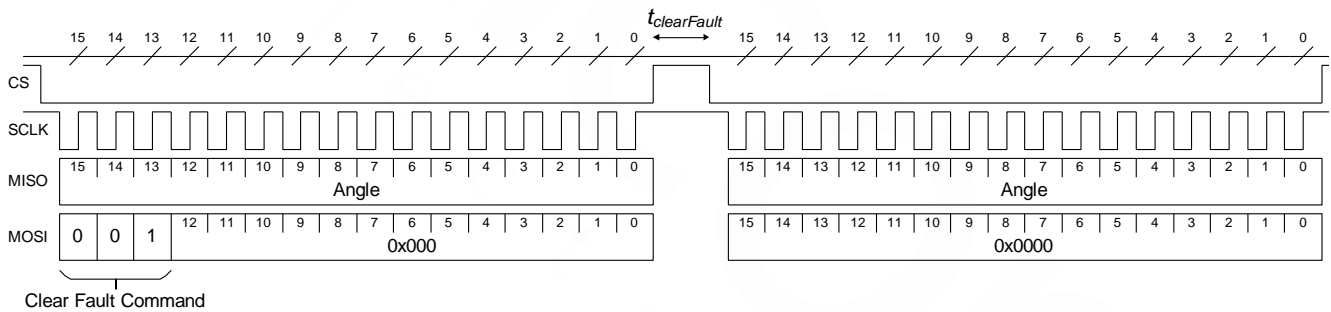
Store All Register Values to NVM (refer to section SPI Store All Registers to NVM)

Restore All Register Values from NVM (refer to section SPI Restore All Registers from NVM)

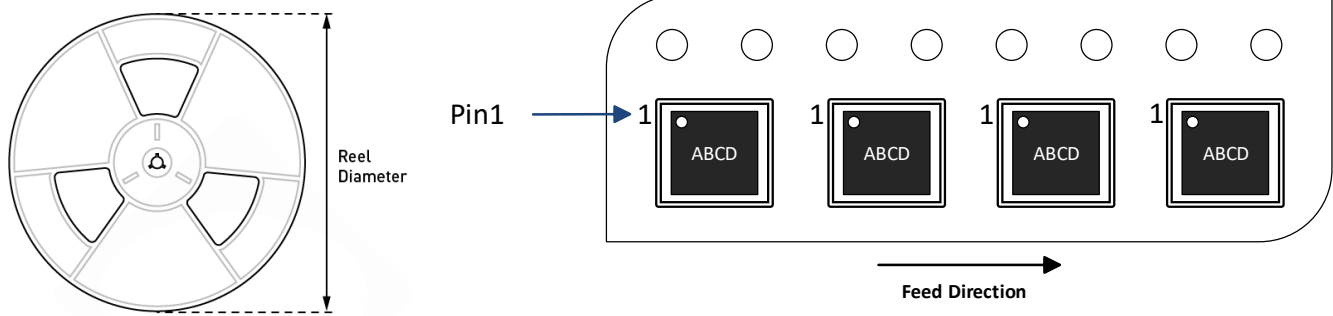
Clear Error Flags (refer to section SPI Clear Error Flags)

CARRIER INFORMATION



Part Number	Package Description	Quantity/Reel	Quantity/Tube	Quantity/Tray	Reel Diameter	Carrier Tape Width	Carrier Tape Pitch
MA782GGU-Z	QFN 2x2	5000	N/A	N/A	13 in.	12mm	8mm

