

**FEATURES**

- ▶ Industrial Standard 2"x1" Package
- ▶ Ultra-wide Input Range 9-36VDC, 18-75VDC, 40-160VDC
- ▶ I/O Isolation 3000VAC with Reinforced Insulation
- ▶ Operating Ambient Temp. Range -40°C to +95°C
- ▶ No Min. Load Requirement
- ▶ Under-voltage, Overload/Voltage and Short Circuit Protection
- ▶ Remote On/Off, Output Voltage Trim
- ▶ Conducted EMI EN 55032/11 Class A Approved
- ▶ Vibration and Shock/Bump Test EN 61373 Approved
- ▶ Cooling, Dry & Damp Heat Test IEC/EN 60068-2-1, 2, 30 Approved
- ▶ Railway EMC Standard EN 50121-3-2 Approved
- ▶ Railway Certified EN 50155 (IEC60571) Approved
- ▶ Fire Protection Test EN 45545-2 Approved
- ▶ UL/cUL/IEC/EN 62368-1(60950-1) Safety Approval & CE Marking

**PRODUCT OVERVIEW**

The MINMAX MKZI10 series is a range of high performance 10W isolated DC-DC converter within encapsulated 2"x1" package which specifically design for railway applications. There are 18 models available for the railway system of multi-input voltage range by 24(9~36)VDC、48(18~75)VDC、72/110(40~160)VDC and fixed output voltage regulation. Further features include under-voltage, overload, over voltage, short circuit protection, remote ON/OFF, output voltage trim and conducted EMI EN 55032/11 Class A approved as well. MKZI10 series conform to vibration and thermal shock/bump test EN 61373, cooling, dry and damp heat test IEC/EN 60068-2-1,2,30 and railway EMC standard EN 50121-3-2 and complies also with Railway Certification EN 50155 (IEC 60571).

MKZI10 series offer an highly reliable solution for critical applications in railway systems, battery-powered equipment, measure instrumentation and many critical applications.

**Model Selection Guide**

Model Number	Input Voltage (Range) VDC	Output Voltage VDC	Output Current		Input Current		Over Voltage Protection VDC	Max. capacitive Load μF	Efficiency (typ.) @Max. Load %
			Max. mA	@Max. Load mA(typ.)	@No Load mA(typ.)				
MKZI10-24S05	24 (9 ~ 36)	5	2000	496	25	6.2	2200	84	
MKZI10-24S12		12	835	485		15	330	86	
MKZI10-24S15		15	670	481		18	220	87	
MKZI10-24S24		24	417	474		30	100	88	
MKZI10-24D12		±12	±417	485		±15	150#	86	
MKZI10-24D15		±15	±335	481		±18	100#	87	
MKZI10-48S05	48 (18 ~ 75)	5	2000	245	15	6.2	2200	85	
MKZI10-48S12		12	835	240		15	330	87	
MKZI10-48S15		15	670	241		18	220	87	
MKZI10-48S24		24	417	242		30	100	86	
MKZI10-48D12		±12	±417	234		±15	150#	89	
MKZI10-48D15		±15	±335	238		±18	100#	88	
MKZI10-110S05	110 (40 ~ 160)	5	2000	111	10	6.2	2200	82	
MKZI10-110S12		12	835	107		15	330	85	
MKZI10-110S15		15	670	107		18	220	85	
MKZI10-110S24		24	417	107		30	100	85	
MKZI10-110D12		±12	±417	106		±15	150#	86	
MKZI10-110D15		±15	±335	106		±18	100#	86	

# For each output

Input Specifications					
Parameter	Model	Min.	Typ.	Max.	Unit
Input Surge Voltage (100ms. max)	24V Input Models	-0.7	---	50	VDC
	48V Input Models	-0.7	---	100	
	110V Input Models	-0.7	---	170	
Start-Up Threshold Voltage	24V Input Models	---	---	9	
	48V Input Models	---	---	18	
	110V Input Models	---	---	40	
Under Voltage Shutdown	24V Input Models	---	7.5	---	
	48V Input Models	---	16	---	
	110V Input Models	---	37	---	
Start Up Time (Power On)	All Models	---	50	---	mS
Input Filter		Internal Pi Type			

Remote On/Off Control					
Parameter	Conditions	Min.	Typ.	Max.	Unit
Converter On	3.5V ~ 12V or Open Circuit				
Converter Off	0V ~ 1.2V or Short Circuit				
Control Input Current (on)	Vctrl = 5.0V	---	0.5	---	mA
Control Input Current (off)	Vctrl = 0V	---	-0.5	---	mA
Control Common	Referenced to Negative Input				
Standby Input Current	Nominal Vin	---	2.5	---	mA

Output Specifications						
Parameter	Conditions / Model		Min.	Typ.	Max.	Unit
Output Voltage Setting Accuracy			---	---	±1.0	%Vnom.
Output Voltage Balance	Dual Output, Balanced Loads		---	---	±2.0	%
Line Regulation	Vin=Min. to Max. @ Full Load		---	---	±0.2	%
Load Regulation	Io=0% to 100%	Single Output	---	---	±0.5	%
		Dual Output	---	---	±1.0	%
Minimum Load	No minimum Load Requirement					
Ripple & Noise	0-20 MHz Bandwidth	5Vo	Measured with a	---	50	mV <sub>P-P</sub>
		12Vo, 15Vo, ±12V, ±15Vo	10µF/25V MLCC	---	100	mV <sub>P-P</sub>
		24Vo	Measured with a	---	150	mV <sub>P-P</sub>
			4.7µF/50V MLCC			
Transient Recovery Time	25% Load Step Change (2)		---	---	300	µsec
Transient Response Deviation			---	±3	±5	%
Temperature Coefficient			---	---	±0.02	%/°C
Trim Up / Down Range (See Page 8)	% of Nominal Output Voltage		---	---	±10	%
Over Load Protection	Hiccup		---	150	---	%
Short Circuit Protection	Continuous, Automatic Recovery (Hiccup Mode 0.3Hz typ.)					

General Specifications					
Parameter	Conditions	Min.	Typ.	Max.	Unit
I/O Isolation Voltage	Reinforced Insulation, Rated For 60 Seconds	3000	---	---	VAC
Isolation Voltage Input/Output to case	Rated For 60 Seconds	1500	---	---	VAC
I/O Isolation Resistance	500 VDC	1000	---	---	MΩ
I/O Isolation Capacitance	100kHz, 1V	---	1500	---	pF
Switching Frequency		---	280	---	kHz
MTBF(calculated)	MIL-HDBK-217F@25°C Full Load, Ground Benign	2,845,385	---	---	Hours
Safety Approval	UL/cUL 60950-1 recognition(UL certificate), IEC/EN 60950-1(CB-report), EN 50155, IEC 60571				
	UL/cUL 62368-1 recognition(UL certificate), IEC/EN 62368-1(CB-report)				

EMC Specifications			
Parameter	Standards & Level		Performance
General	Compliance with EN 50121-3-2 Railway Applications		
EMI	Conduction	EN 55032/11	Without external components
	Radiation		With external components
EMS	EN 55024		
	ESD	EN 61000-4-2 Air $\pm$ 8kV, Contact $\pm$ 6kV	A
	Radiated immunity	EN 61000-4-3 10V/m	A
	Fast transient <sup>(6)</sup>	EN 61000-4-4 $\pm$ 2kV	A
	Surge <sup>(6)</sup>	EN 61000-4-5 $\pm$ 2kV	A
	Conducted immunity	EN 61000-4-6 10Vrms	A
	PFMF	EN 61000-4-8 100A/m, 1000A/m For 1 Second	A

Environmental Specifications					
Parameter	Conditions / Model	Min.	Max.		Unit
			without Heatsink	with Heatsink	
Operating Ambient Temperature Range Nominal Vin, Load 100% Inom. (for Power Derating see relative Derating Curves)	MKZI10-48D12	-40	90	93	°C
	MKZI10-24S24, MKZI10-48D15		88	92	
	MKZI10-24S15, MKZI10-48S12, MKZI10-48S15 MKZI10-24D15		87	90	
	MKZI10-24S12, MKZI10-48S24, MKZI10-24D12, MKZI10-110D12, MKZI10-110D15		85	89	
	MKZI10-48S05, MKZI10-110S12, MKZI10-110S15, MKZI10-110S24		84	88	
	MKZI10-24S05		82	86	
	MKZI10-110S05		78	83	
Thermal Impedance	20LFM Convection without Heatsink	12.1	---	---	°C/W
	20LFM Convection with Heatsink	9.8	---	---	°C/W
	100LFM Convection without Heatsink	9.2	---	---	°C/W
	100LFM Convection with Heatsink	5.4	---	---	°C/W
	200LFM Convection without Heatsink	7.8	---	---	°C/W
	200LFM Convection with Heatsink	4.5	---	---	°C/W
	400LFM Convection without Heatsink	5.2	---	---	°C/W
	400LFM Convection with Heatsink	3.0	---	---	°C/W
Case Temperature		---	+105	---	°C
Storage Temperature Range		-50	+125	---	°C
Cooling Test	Compliance to IEC/EN60068-2-1				
Dry Heat	Compliance to IEC/EN60068-2-2				
Damp Heat	Compliance to IEC/EN60068-2-30				
Shock & Vibration Test	Compliance to IEC/EN 61373				
Humidity (non condensing)		---	95	---	% rel. H
RFI	Six-Sided Shielded, Metal Case				
Lead Temperature (1.5mm from case for 10Sec.)		---	260	---	°C

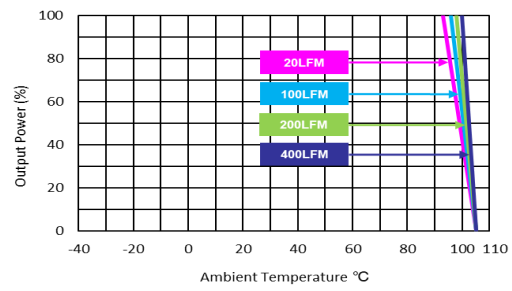
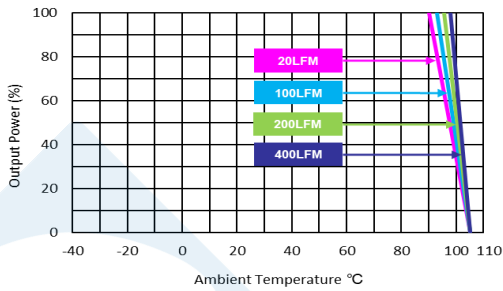
**Power Derating Curve**

MKZI10-48D12 Derating Curve without Heatsink

MKZI10-48D12 Derating Curve with Heatsink

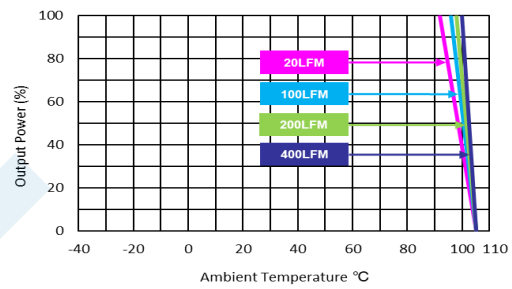
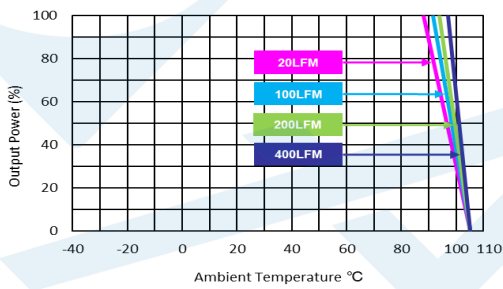

MKZI10-24S24, MKZI10-48D15 Derating Curve without Heatsink

MKZI10-24S24, MKZI10-48D15 Derating Curve with Heatsink

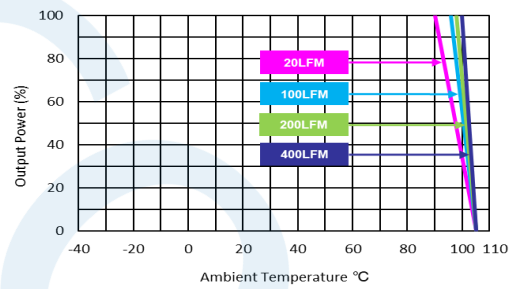
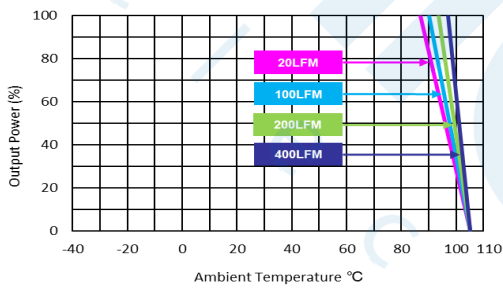

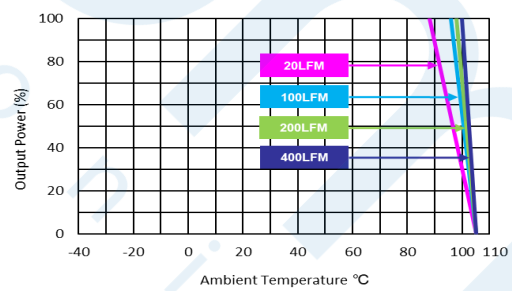
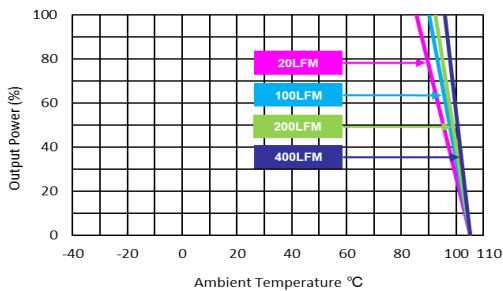
 MKZI10-24S15, MKZI10-24D15, MKZI10-48S12, MKZI10-48S15  
Derating Curve without Heatsink

 MKZI10-24S15, MKZI10-24D15, MKZI10-48S12, MKZI10-48S15  
Derating Curve with Heatsink

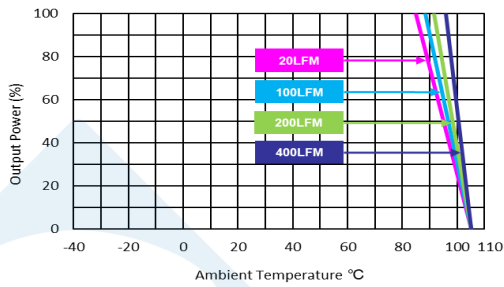
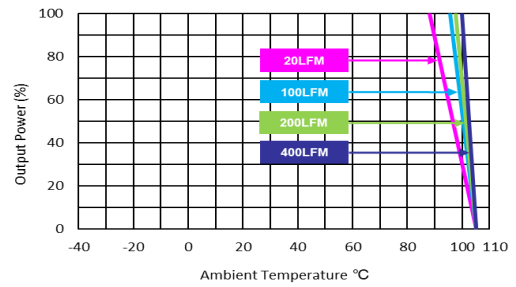
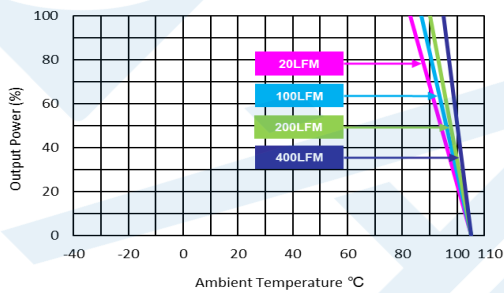
 MKZI10-24S12, MKZI10-24D12, MKZI10-48S24, MKZI10-110D12  
MKZI10-110D15 Derating Curve without Heatsink

 MKZI10-24S12, MKZI10-24D12, MKZI10-48S24, MKZI10-110D12  
MKZI10-110D15 Derating Curve with Heatsink

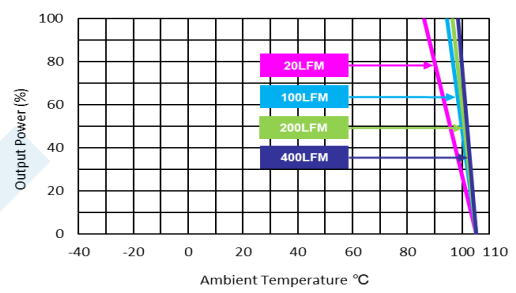
**Power Derating Curve**

 MKZI10-48S05, MKZI10-110S12, MKZI10-110S15, MKZI10-110S24  
 Derating Curve without Heatsink

 MKZI10-48S05, MKZI10-110S12, MKZI10-110S15, MKZI10-110S24  
 Derating Curve with Heatsink

MKZI10-24S05 Derating Curve without Heatsink

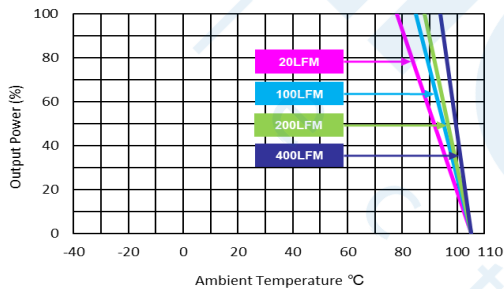

MKZI10-24S05 Derating Curve with Heatsink



MKZI10-110S05 Derating Curve without Heatsink

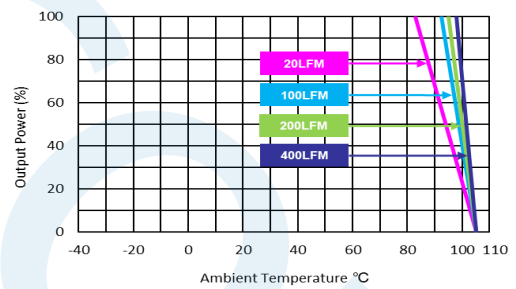

MKZI10-110S05 Derating Curve with Heatsink

**Notes**

- 1 Specifications typical at  $T_a = +25^\circ\text{C}$ , resistive load, nominal input voltage and rated output current unless otherwise noted.
- 2 Transient recovery time is measured to within 1% error band for a step change in output load of 75% to 100%.
- 3 We recommend to protect the converter by a slow blow fuse in the input supply line.
- 4 Other input and output voltage may be available, please contact MINMAX.
- 5 To meet EN 55032/11 Radiation Class A an external filter, please contact MINMAX.
- 6 To meet EN 61000-4-4 & EN 61000-4-5 an external capacitor across the input pins is required, please contact MINMAX.
- 7 Specifications are subject to change without notice.

**Package Specifications**

## Mechanical Dimensions

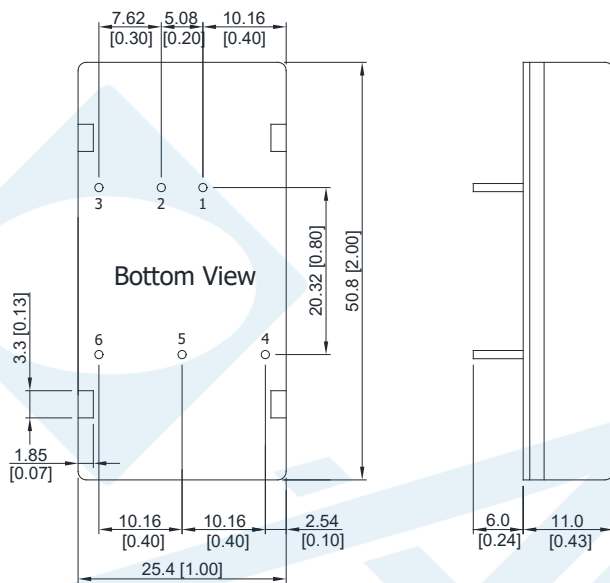

## Pin Connections

Pin	Single Output	Dual Output	Diameter mm (inches)
1	+Vin	+Vin	∅ 1.00 [0.04]
2	-Vin	-Vin	∅ 1.00 [0.04]
3	Remote On/Off	Remote On/Off	∅ 1.00 [0.04]
4	+Vout	+Vout	∅ 1.00 [0.04]
5	Trim	Common	∅ 1.00 [0.04]
6	-Vout	-Vout	∅ 1.00 [0.04]

NC: No Connection

- ▶ All dimensions in mm (inches)
- ▶ Tolerance: X.X±0.75 (X.XX±0.03)  
X.XX±0.25 (X.XXX±0.01)
- ▶ Pin diameter ∅ 1.0 ±0.05 (0.04±0.002)

**Package Specifications with "A" Pinning (order code suffix A)**

## Mechanical Dimensions

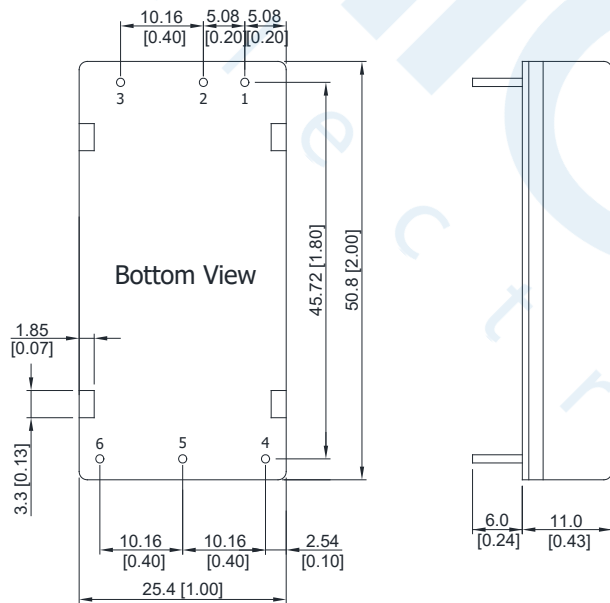

## Pin Connections

Pin	Single Output	Dual Output	Diameter mm (inches)
1	+Vin	+Vin	∅ 1.00 [0.04]
2	-Vin	-Vin	∅ 1.00 [0.04]
3	Remote On/Off	Remote On/Off	∅ 1.00 [0.04]
4	+Vout	+Vout	∅ 1.00 [0.04]
5	-Vout	Common	∅ 1.00 [0.04]
6	Trim	-Vout	∅ 1.00 [0.04]

NC: No Connection

- ▶ All dimensions in mm (inches)
- ▶ Tolerance: X.X±0.75 (X.XX±0.03)  
X.XX±0.25 (X.XXX±0.01)
- ▶ Pin diameter ∅ 1.0 ±0.05 (0.04±0.002)

**Physical Characteristics**

Case Size	: 50.8x25.4x11.0 mm (2.0x1.0x0.43 inches)
Case Material	: Metal With Non-Conductive Baseplate
Base Material	: FR4 PCB (flammability to UL 94V-0 rated)
Insulated Frame Material	: Non-Conductive Black Plastic (flammability to UL 94V-0 rated)
Pin Material	: Copper Alloy
Potting Material	: Silicone (UL94-V0)
Weight	: 40.5g

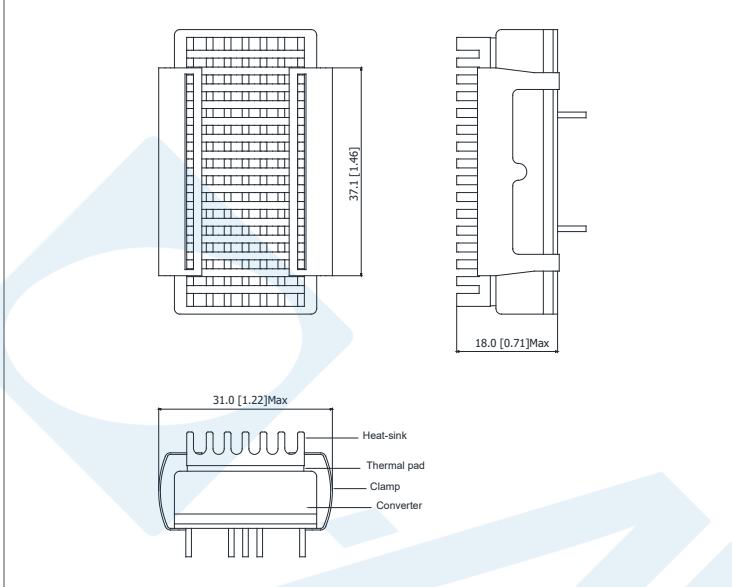
**Heatsink (Option, -HS)**

**Physical Characteristics**

Heatsink Material	: Aluminum
Finish	: Black Anodized Coating
Weight	: 9g

► The advantages of adding a heatsink are:

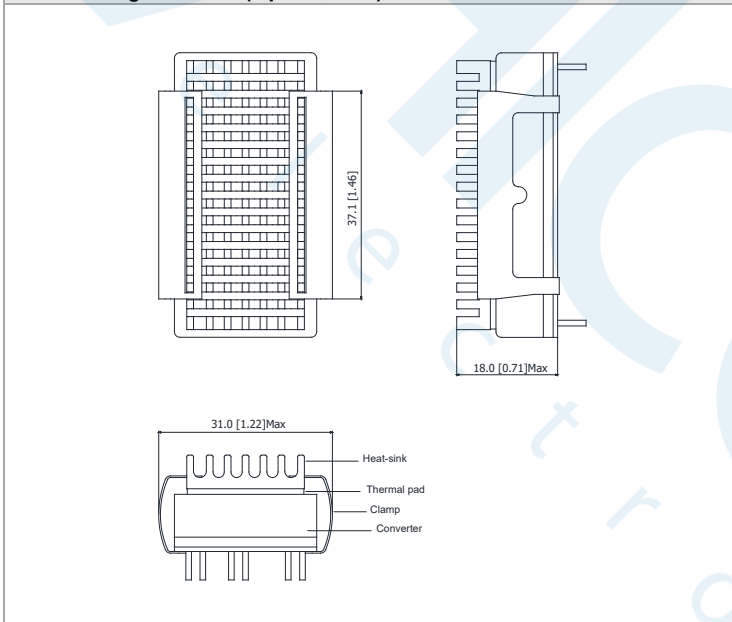
1. To improve heat dissipation and increase the stability and reliability of the DC-DC converters at high operating temperatures.
2. To increase operating temperature of the DC-DC converter, please refer to Derating Curve.

**"A" Pinning Heatsink (Option, -HS)**

**External Output Trimming**

Output can be externally trimmed by using the method shown below

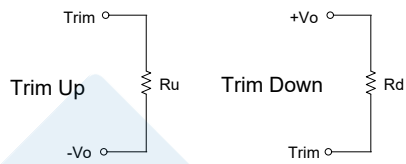

Trim Range (%)	MKZI10-XXS05		MKZI10-XXS12		MKZI10-XXS15		MKZI10-XXS24	
	Trim down (kΩ)	Trim up (kΩ)	Trim down (kΩ)	Trim up (kΩ)	Trim down (kΩ)	Trim up (kΩ)	Trim down (kΩ)	Trim up (kΩ)
1	137.88	108.09	419.81	344.74	602.92	482.88	598.97	486.83
2	61.93	48.39	187.68	154.37	269.91	215.89	267.93	217.87
3	36.61	28.49	110.30	90.92	158.91	126.89	157.59	128.21
4	23.95	18.54	71.61	59.19	103.41	82.40	102.42	83.38
5	16.35	12.56	48.40	40.15	70.10	55.70	69.31	56.49
6	11.29	8.58	32.93	27.46	47.90	37.90	47.25	38.56
7	7.67	5.74	21.87	18.39	32.05	25.18	31.48	25.75
8	4.96	3.61	13.58	11.59	20.15	16.65	19.66	16.14
9	2.85	1.95	7.13	6.31	10.90	8.23	10.46	8.67
10	1.16	0.62	1.98	2.07	3.50	2.30	3.11	2.69



**Order Code Table**

Standard	With heatsink	With "A" Pinning	With "A" Pinning & heatsink
MKZI10-24S05	MKZI10-24S05-HS	MKZI10-24S05A	MKZI10-24S05A-HS
MKZI10-24S12	MKZI10-24S12-HS	MKZI10-24S12A	MKZI10-24S12A-HS
MKZI10-24S15	MKZI10-24S15-HS	MKZI10-24S15A	MKZI10-24S15A-HS
MKZI10-24S24	MKZI10-24S24-HS	MKZI10-24S24A	MKZI10-24S24A-HS
MKZI10-24D12	MKZI10-24D12-HS	MKZI10-24D12A	MKZI10-24D12A-HS
MKZI10-24D15	MKZI10-24D15-HS	MKZI10-24D15A	MKZI10-24D15A-HS
MKZI10-48S05	MKZI10-48S05-HS	MKZI10-48S05A	MKZI10-48S05A-HS
MKZI10-48S12	MKZI10-48S12-HS	MKZI10-48S12A	MKZI10-48S12A-HS
MKZI10-48S15	MKZI10-48S15-HS	MKZI10-48S15A	MKZI10-48S15A-HS
MKZI10-48S24	MKZI10-48S24-HS	MKZI10-48S24A	MKZI10-48S24A-HS
MKZI10-48D12	MKZI10-48D12-HS	MKZI10-48D12A	MKZI10-48D12A-HS
MKZI10-48D15	MKZI10-48D15-HS	MKZI10-48D15A	MKZI10-48D15A-HS
MKZI10-110S05	MKZI10-110S05-HS	MKZI10-110S05A	MKZI10-110S05A-HS
MKZI10-110S12	MKZI10-110S12-HS	MKZI10-110S12A	MKZI10-110S12A-HS
MKZI10-110S15	MKZI10-110S15-HS	MKZI10-110S15A	MKZI10-110S15A-HS
MKZI10-110S24	MKZI10-110S24-HS	MKZI10-110S24A	MKZI10-110S24A-HS
MKZI10-110D12	MKZI10-110D12-HS	MKZI10-110D12A	MKZI10-110D12A-HS
MKZI10-110D15	MKZI10-110D15-HS	MKZI10-110D15A	MKZI10-110D15A-HS

**Order Code For Heatsink kit (including: Heatsink x1, Clamp x 2, Thermal Pad x1)**

HS-K003

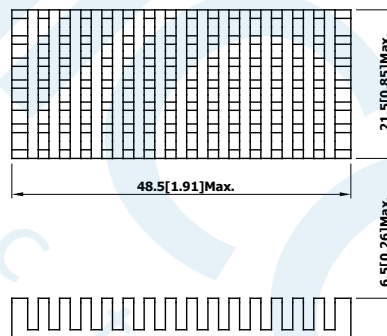

## Test Setup

### Peak-to-Peak Output Noise Measurement Test

Use a 1 $\mu$ F ceramic capacitor and a 10 $\mu$ F tantalum capacitor. Scope measurement should be made by using a BNC socket, measurement bandwidth is 0-20 MHz. Position the load between 50 mm and 75 mm from the DC-DC Converter.

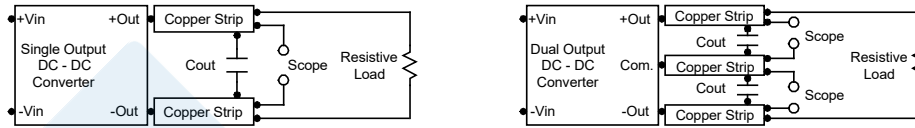

## Technical Notes

### Remote On/Off

Positive logic remote on/off turns the module on during a logic high voltage on the remote on/off pin, and off during a logic low. To turn the power module on and off, the user must supply a switch to control the voltage between the on/off terminal and the -Vin terminal. The switch can be an open collector or equivalent. A logic low is 0V to 1.2V. A logic high is 3.5V to 12V. The maximum sink current at the on/off terminal (Pin 3) during a logic low is -100 $\mu$ A.

### Overload Protection

To provide hiccup mode protection in a fault (output overload) condition, the unit is equipped with internal current limiting circuitry and can endure overload for an unlimited duration.

### Overvoltage Protection

The output overvoltage clamp consists of control circuitry, which is independent of the primary regulation loop, that monitors the voltage on the output terminals. The control loop of the clamp has a higher voltage set point than the primary loop. This provides a redundant voltage control that reduces the risk of output overvoltage. The OVP level can be found in the output data.

### Input Source Impedance

The power module should be connected to a low ac-impedance input source. Highly inductive source impedances can affect the stability of the power module. In applications where power is supplied over long lines and output loading is high, it may be necessary to use a capacitor at the input to ensure startup. Capacitor mounted close to the power module helps ensure stability of the unit, it is recommended to use a good quality low Equivalent Series Resistance (ESR < 1.0 $\Omega$  at 100 kHz) capacitor of 4.7 $\mu$ F for the 24V input devices, a 2.2 $\mu$ F for the 48V devices and a 1 $\mu$ F for the 110V devices.

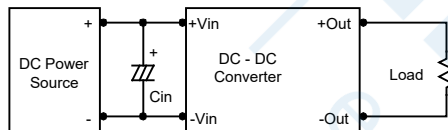

### Output Ripple Reduction

A good quality low ESR capacitor placed as close as practicable across the load will give the best ripple and noise performance. To reduce output ripple, it is recommended to use 4.7 $\mu$ F capacitors at the output.

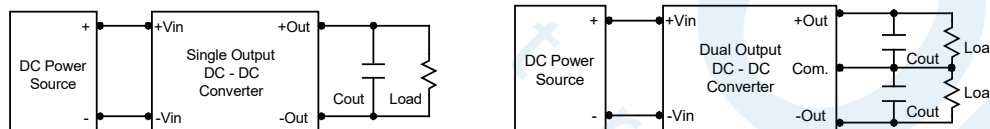

### Maximum Capacitive Load

The MKZI10 series has limitation of maximum connected capacitance at the output. The power module may be operated in current limiting mode during start-up, affecting the ramp-up and the startup time. The maximum capacitance can be found in the data sheet.

### Thermal Considerations

Many conditions affect the thermal performance of the power module, such as orientation, airflow over the module and board spacing. To avoid exceeding the maximum temperature rating of the components inside the power module, the case temperature must be kept below 105°C. The derating curves are determined from measurements obtained in a test setup.

