



# MIE1W0505BGLVH

## 5V, 1W, Regulated, 2.5kVrms Isolated DC-DC Module

**PRELIMINARY SPECIFICATIONS SUBJECT TO CHANGE**

### DESCRIPTION

The MIE1W0505BGLVH is an isolated, regulated, DC to DC module. It can support 3V to 5.5V input voltage application. MIE1W0505BGLVH have excellent load regulation, line regulation, supporting up to 1W output power.

MIE1W0505BGLVH integrated power MOS, transformer and feedback circuit all in one chip, achieving excellent performance and saving size.

MIE1W0505BGLVH supports regulated output, when Vout drops and is lower than target voltage, the IC starts to switch, delivering power from Vin to Vout until Vout reach to the target output value again.

MIE1W0505BGLVH integrated output voltage feedback block, which can regulate output voltage without traditional opto-coupler and TL431. This module provides small size and higher reliability operation comparing to traditional isolation power module.

MIE1W0505BGLVH features with continuous short circuit protection and over temperature protection. It's available in a small LGA-12 (4mmx5mm) package.

### FEATURES

- 3V to 5.5V Input Voltage Operation Range
- Selectable 5V or 3.3V Output Voltage ( $V_{OUT}$ )
  - 5V to 5V:  $\geq 200\text{mA}$  Available Load Current
  - 5V to 3.3V:  $\geq 200\text{mA}$  Available Load Current
  - 3.3V to 3.3V:  $\geq 75\text{mA}$  Available Load Current
- 2.5kVrms Isolation Voltage
- Support Infinite Capacitive Load
- 0.4% Load Regulation
- 0.3% Line Regulation
- Continuous Short Circuit Protection
- Over-temperature Protection
- CB Certification According to IEC62368-1 (Ongoing)
- Meet EN55032 Class B Emissions
- Operation Temperature:  $-40^{\circ}\text{C}$  to  $125^{\circ}\text{C}$
- Available in LGA-12 (4mmx5mm) Package

### APPLICATIONS

- Industrial Automation Systems
- Isolated Bias Power for Digital Isolators
- Isolated Power for Isolated RS-485/RS422/CAN interface
- Isolated Sensor Power Supply
- Telecom and Network Device (5G RRU, Industrial CPE, Network Gateway, etc.)

All MPS parts are lead-free, halogen-free, and adhere to the RoHS directive. For MPS green status, please visit the MPS website under Quality Assurance. "MPS", the MPS logo, and "Simple, Easy Solutions" are trademarks of Monolithic Power Systems, Inc. or its subsidiaries.

### TYPICAL APPLICATION

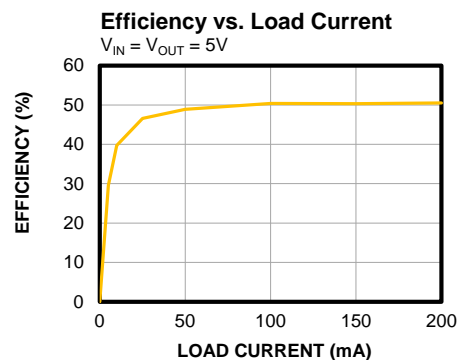
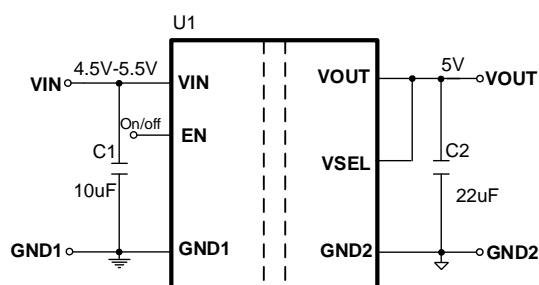

### ORDERING INFORMATION

Part Number*	Package	Top Marking	MSL Rating
MIE1W0505BGLVH-3R	LGA-12 (4mmx5mm)	See below	3

\* For Tape & Reel, add suffix -Z (e.g. MIE1W0505BGLVH-3R-Z).

### TOP MARKING

**MPSYWW**

**1W0505**

**LLLLLL**

**BH**

MPS: MPS prefix  
 Y: Year code  
 WW: Week code  
 1W0505: Part number  
 LLLLLL: Lot number  
 BH: Suffix of part number

### PACKAGE REFERENCE

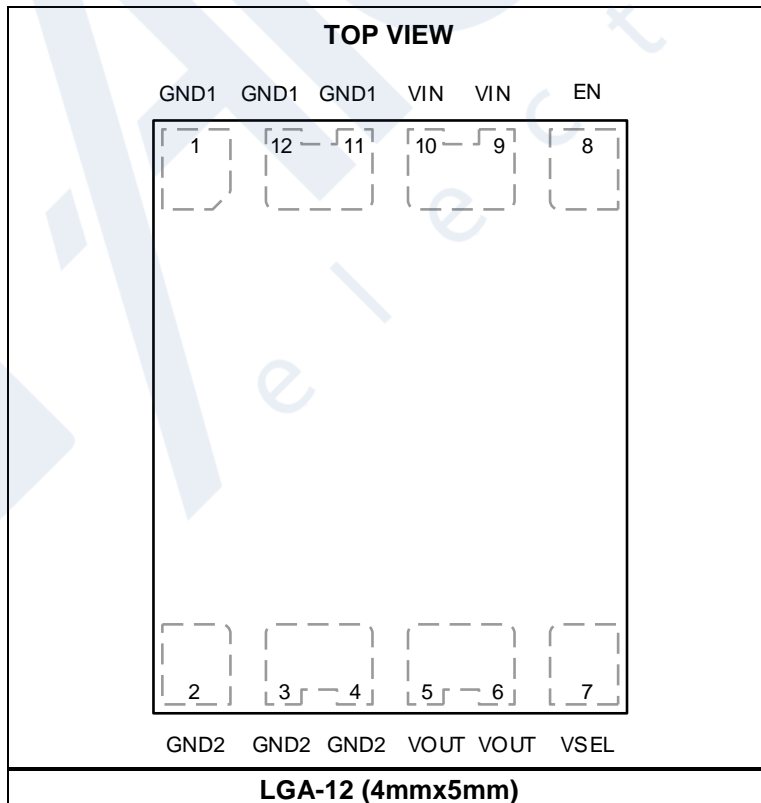

**PIN FUNCTIONS**

LGA-12 (4mmx5mm) Pin #	Name	Description
1, 11, 12	GND1	<b>Side 1 Ground Pin.</b>
2, 3, 4	GND2	<b>Side 2 Ground Pin.</b>
5, 6	VOUT	<b>Power Output Pin.</b> Typically connect a 22 $\mu$ F plus 0.1 $\mu$ F between VOUT and GND2 (pin3 and pin4) to decrease VOUT ripple and noise.
7	VSEL	<b>Output voltage set pin.</b> Must connect to VOUT or float for 5V output and must connect to GND2 for 3.3V output. Don't bias VSEL with other power and 5V output can't switch to 3.3V output after startup.
8	EN	<b>Power Enable Pin.</b> Pull high to enable MIE1W0505BGLVH, pull low to disable MIE1W0505BGLVH. Don't let this pin floating.
9, 10	VIN	<b>Power Supply Input Pin.</b> Connect to a 3V-5.5V power supply, typically connect a 10 $\mu$ F plus 0.1 $\mu$ F between VIN and GND1 (pin11 and pin12) to make IC work stable.

**ABSOLUTE MAXIMUM RATINGS** <sup>(1)</sup>

VIN/EN to GND1 .....	-0.3V to +6.5V
VOUT/VSEL to GND2.....	-0.3V to +6.5V
Continuous Power Dissipation (T <sub>A</sub> = +25°C) <sup>(2)(4)</sup>	1.78W
Junction Temperature .....	150°C
Lead Temperature .....	260°C
Storage Temperature.....	-65°C to +150°C

**ESD Ratings**

Human body model (HBM) .....	±5000V
Charged device model (CDM) .....	±2000V

**Recommended Operating Conditions** <sup>(3)</sup>

Supply Voltage V <sub>IN</sub> .....	3V to 5.5V
Output Voltage V <sub>OUT</sub> .....	5/3.3V
Operating Junction Temp. (T <sub>J</sub> ) .	-40°C to +125°C

Thermal Resistance	$\theta_{JA}$	$\theta_{JC}$
LGA-12 (4mmx5mm)		
EV1W0505B-LVH-00A <sup>(4)</sup> .....	70	22 .. °C/W
JESD51-7 <sup>(5)</sup> .....	61	19... °C/W

**Notes:**

- Exceeding these ratings may damage the device.
- The maximum allowable power dissipation is a function of the maximum junction temperature T<sub>J</sub> (MAX), the junction-to-ambient thermal resistance  $\theta_{JA}$ , and the ambient temperature T<sub>A</sub>. The maximum allowable continuous power dissipation at any ambient temperature is calculated by P<sub>D</sub> (MAX) = (T<sub>J</sub> (MAX) - T<sub>A</sub>) /  $\theta_{JA}$ . Exceeding the maximum allowable power dissipation produces an excessive die temperature, causing the regulator to go into thermal shutdown. Internal thermal shutdown circuitry protects the device from permanent damage.
- The device is not guaranteed to function outside of its operating conditions.
- Measured on EV1W0505B-LVH-00A (51mmx51mm), 1oz, 2-layer PCB.
- The value of  $\theta_{JA}$  given in this table is only valid for comparison with other packages and cannot be used for design purposes. These values were calculated in accordance with JESD51-7, and simulated on a specified JEDEC board. They do not represent the performance obtained in an actual application.

## ELECTRICAL CHARACTERISTICS

$V_{IN} = 5V$ ,  $V_{OUT} = 5V$ ,  $T_J = -40^{\circ}C$  to  $+125^{\circ}C$  <sup>(6)</sup>, typical values are tested at  $T_J = 25^{\circ}C$ , unless otherwise noted.

Parameter	Symbol	Condition	Min	Typ	Max	Units
<b>Power Supply</b>						
VIN Under Voltage Lockout Threshold Rising	$V_{INUVLO-R}$	$V_{IN}$ Rising		2.6	2.8	V
VIN Under Voltage Lockout Threshold Hysteresis	$V_{INHYS}$			220		mV
Shutdown Current	$I_{SD}$	$V_{EN} = 0V$ , Measured on VIN pin		7		$\mu A$
Input Current	$I_{IN}$	Load = 0A		8		mA
		Load = 0.2A		395		mA
EN Input High Threshold					2	V
EN Input Voltage Low Threshold			0.4			V
EN Input Current Leakage		EN connect to GND1		-5		$\mu A$
Output Voltage Accuracy	$V_{O\_ACC}$	$T_J=25^{\circ}C$ , $V_{IN}=4.5V$ to $5.5V$ , $I_o=0A$ , $C_o=22\mu F$	4.925	5	5.075	V
		$T_J=-40^{\circ}C$ to $+125^{\circ}C$ , $V_{IN}=4.5V$ to $5.5V$ , $I_o=0A$ , $C_o=22\mu F$	4.9	5	5.1	V
Load Regulation		Load=0A to 0.2A		0.4	2.5	%
Line Regulation		$V_{IN}=4.5V$ to $5.5V$ , Load=0.2A		0.3	2.5	%
Efficiency		Load=0.2A		50.5		%
Ripple		$T_A = 25^{\circ}C$		60	100	mV
Isolated Voltage	$V_{ISO}$	Short all primary pin and all secondary pin as a two terminal part, Test time=60s, qualified test	2.5			kVrms
		Short all primary pin and all secondary pin as a two terminal part, Test time=1s, production test, 100% test	3			kVrms
Input to Output Capacitance <sup>(7)</sup>	$C_{I-O}$	Short all primary pin and all secondary pin as a two terminal part, measuring frequency=1MHz		5		pF
Input to Output Resistance <sup>(7)</sup>	$R_{I-O}$	Short all primary pin and all secondary pin as a two terminal part, test voltage=500VDC	50			G $\Omega$
<b>Thermal Shutdown<sup>(7)</sup></b>						
Thermal Shut down Temperature	$T_{SD}$			150		$^{\circ}C$
Thermal Shut down Hysteresis	$T_{SD-HYS}$			20		$^{\circ}C$

**ELECTRICAL CHARACTERISTICS (continued)**

$V_{IN} = 5V$ ,  $V_{OUT} = 3.3V$ ,  $T_J = -40^{\circ}C$  to  $+125^{\circ}C$  <sup>(6)</sup>, typical values are tested at  $T_J = 25^{\circ}C$ , unless otherwise noted.

Parameter	Symbol	Condition	Min	Typ	Max	Units
<b>Power Supply</b>						
Shutdown Current	$I_{SD}$	$V_{EN} = 0V$ , Measured on VIN pin		7		$\mu A$
Input Current	$I_{IN}$	Load=0A		5		mA
		Load=0.2A		354		mA
EN Input Current Leakage		EN connect to GND1		-5		$\mu A$
Output Voltage Accuracy	$V_{O\_ACC}$	$T_J=25^{\circ}C$ , $V_{IN}=4.5V$ to $5.5V$ , $I_o=0A$ , $C_o=22\mu F$	3.2	3.3	3.4	V
		$T_J=-40^{\circ}C$ to $+125^{\circ}C$ , $V_{IN}=4.5V$ to $5.5V$ , $I_o=0A$ , $C_o=22\mu F$	3.18	3.3	3.42	V
Load Regulation		Load=0A to 0.2A		0.4	2.5	%
Line Regulation		$V_{IN}=4.5V$ to $5.5V$ , Load=0.2A		0.2	2	%
Efficiency		Load=0.2A		37		%
Ripple		$T_A = 25^{\circ}C$		50	90	mV

**ELECTRICAL CHARACTERISTICS (continued)**

$V_{IN} = 3.3V$ ,  $V_{OUT} = 3.3V$ ,  $T_J = -40^{\circ}C$  to  $+125^{\circ}C$  <sup>(6)</sup>, typical values are tested at  $T_J = 25^{\circ}C$ , unless otherwise noted.

Parameter	Symbol	Condition	Min	Typ	Max	Units
<b>Power Supply</b>						
Shutdown Current	$I_{SD}$	$V_{EN} = 0V$ , Measured on VIN pin		5		$\mu A$
Input Current	$I_{IN}$	Load=0A		5		mA
		Load=0.075A		150		mA
EN Input Current Leakage		EN connect to GND1		-3.3		$\mu A$
Output Voltage Accuracy	$V_{O\_ACC}$	$T_J=25^{\circ}C$ , $V_{IN}=3V$ to $3.6V$ , $I_o=0A$ , $C_o=22\mu F$	3.2	3.3	3.4	V
		$T_J=-40^{\circ}C$ to $+125^{\circ}C$ , $V_{IN}=3V$ to $3.6V$ , $I_o=0A$ , $C_o=22\mu F$	3.18	3.3	3.42	V
Load Regulation		Load=0A to 0.075A		0.3	2	%
Line Regulation		$V_{IN}=3V$ to $3.6V$ , Load=0.075A		0.2	1.5	%
Efficiency		Load=0.075A		50		%
Ripple		$T_A = 25^{\circ}C$		30	60	mV

**Notes:**

- 6) Guaranteed by over-temperature correlation. Not tested in production.
- 7) Guaranteed by sample characterization, not tested in production.

## TYPICAL CHARACTERISTICS

$V_{IN} = 5V$ ,  $V_{OUT} = 5V$ ,  $C_{IN} = 10\mu F$ ,  $C_{OUT} = 0.1\mu F + 22\mu F$ ,  $T_A = 25^\circ C$ , unless otherwise noted.

**Output Voltage Accuracy vs. Temperature**

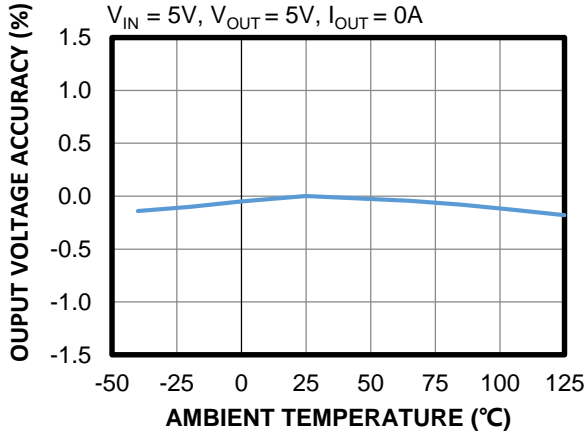

**Output Voltage Accuracy vs. Temperature**

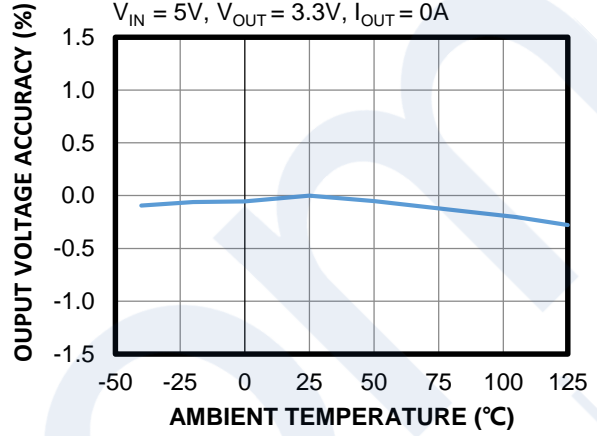

**Output Voltage Accuracy vs. Temperature**

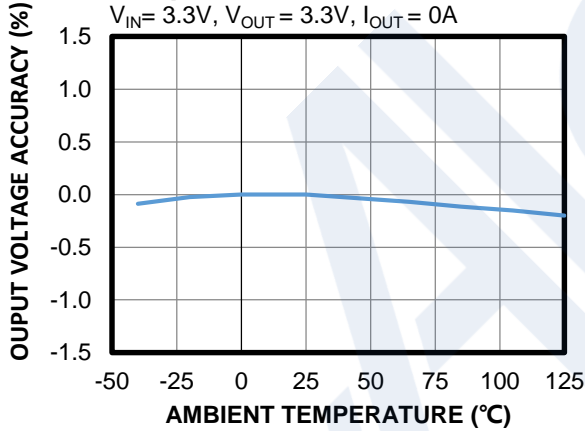

**Shutdown current vs. Temperature**

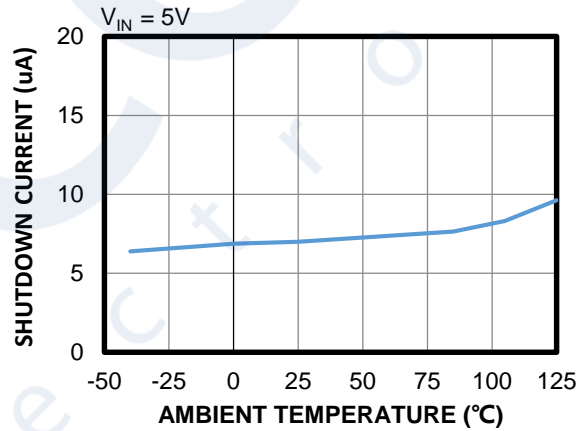

### TYPICAL PERFORMANCE CHARACTERISTICS

$V_{IN} = 5V$ ,  $V_{OUT} = 5V$ ,  $C_{IN} = 10\mu F$ ,  $C_{OUT} = 0.1\mu F + 22\mu F$ ,  $T_A = 25^\circ C$ , unless otherwise noted.

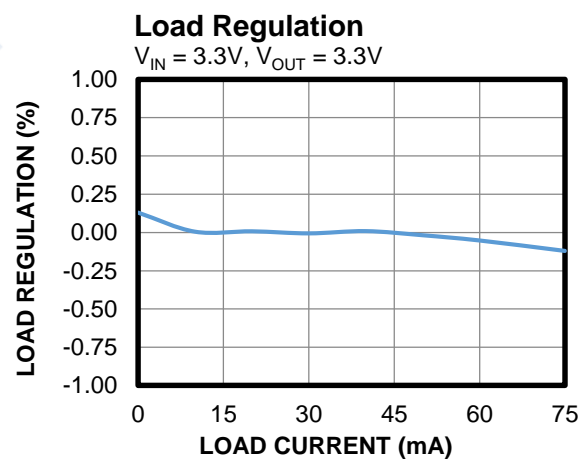
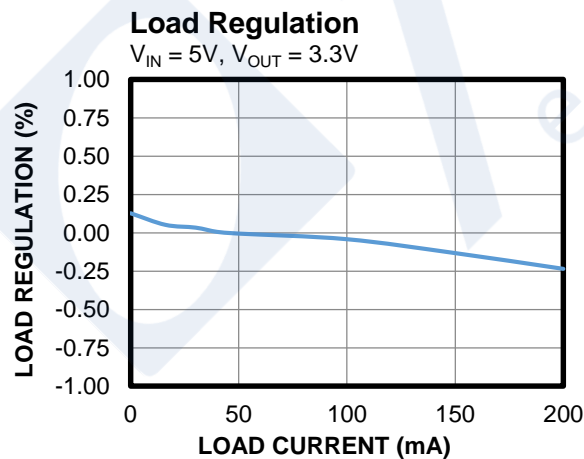
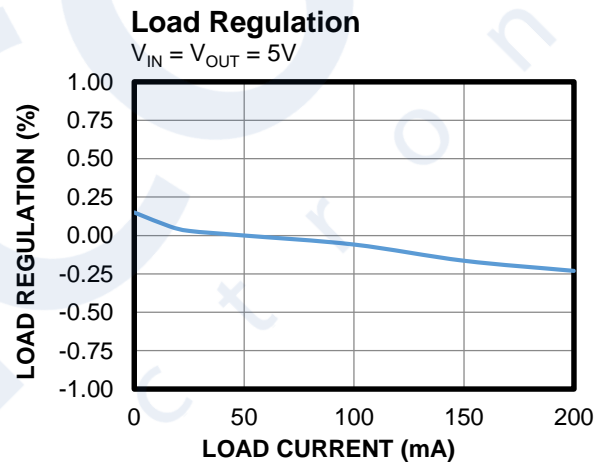
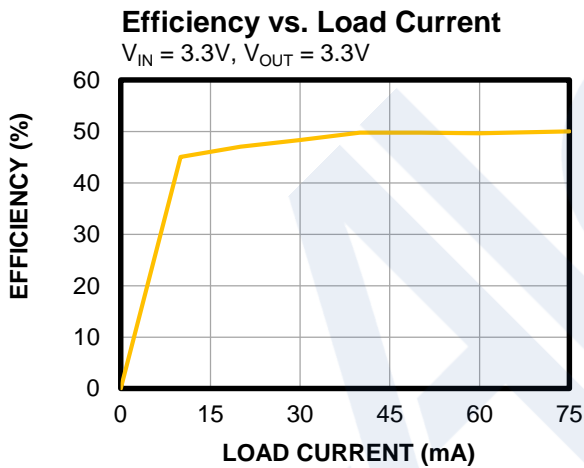
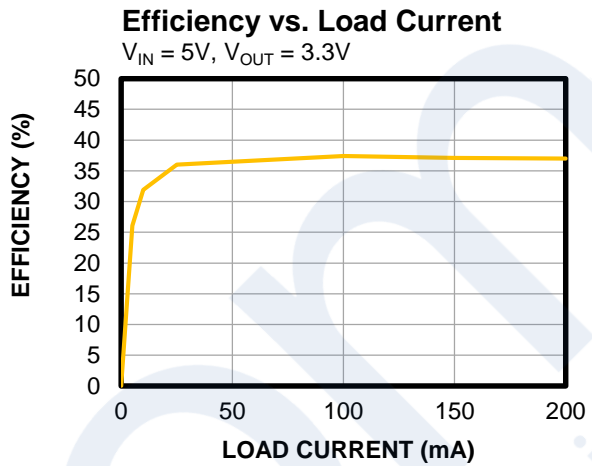
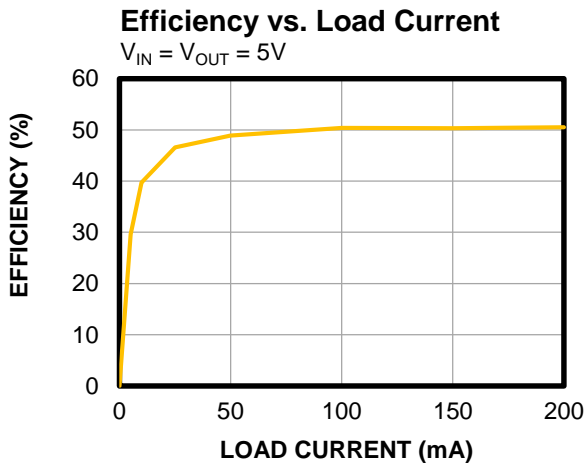



**TYPICAL PERFORMANCE CHARACTERISTICS (continued)**

$V_{IN} = 5V$ ,  $V_{OUT} = 5V$ ,  $C_{IN} = 10\mu F$ ,  $C_{OUT} = 0.1\mu F + 22\mu F$ ,  $T_A = 25^\circ C$ , unless otherwise noted.

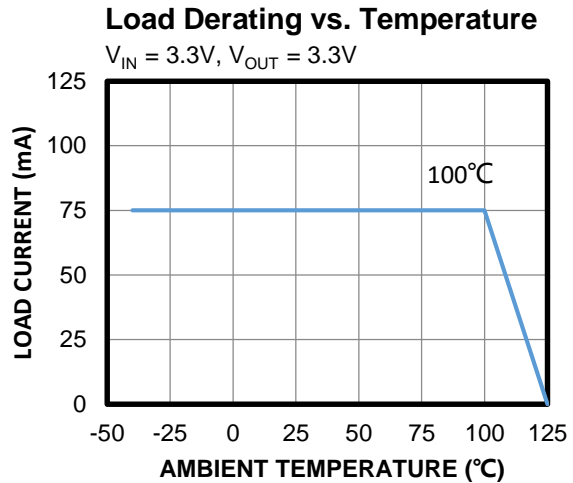
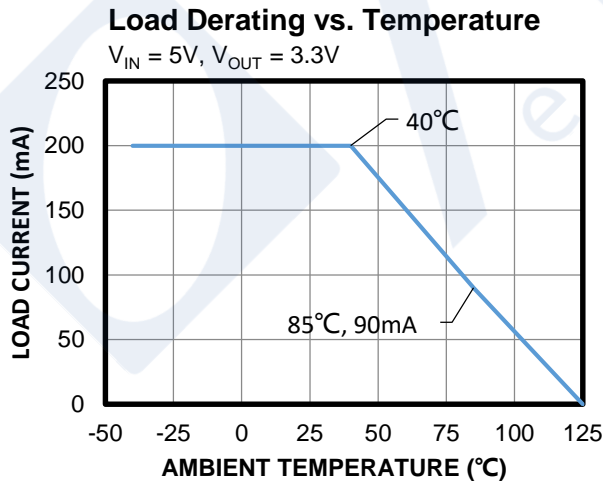
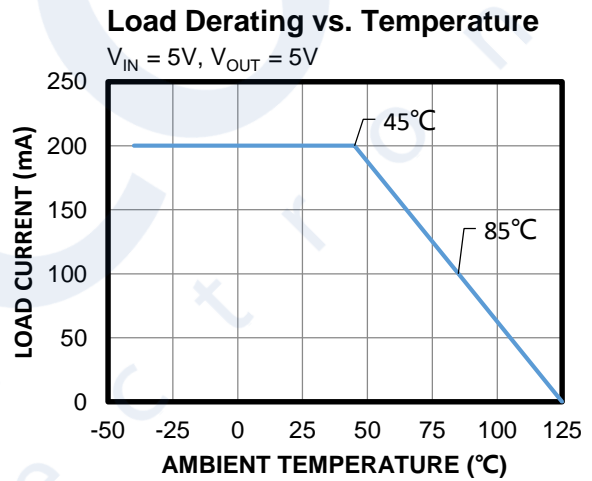
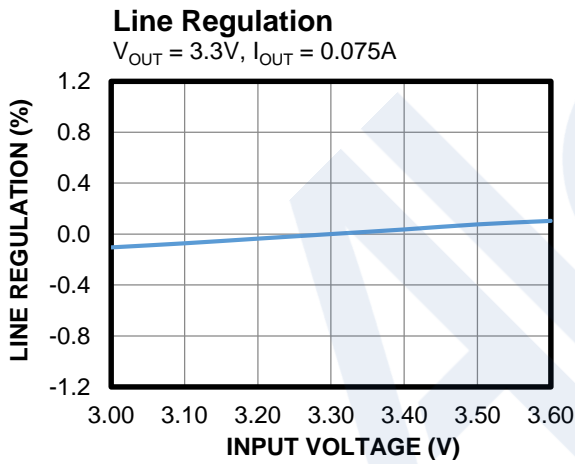
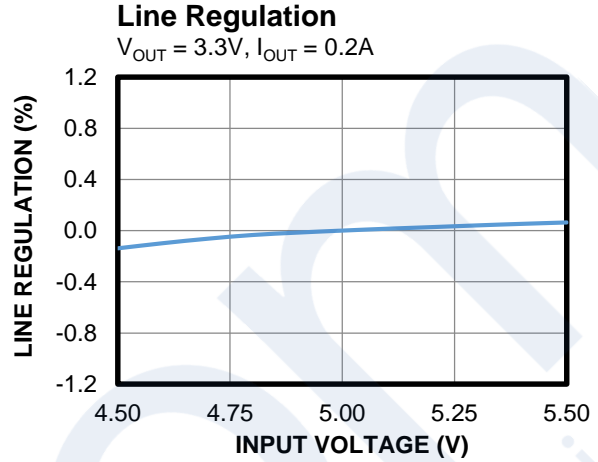
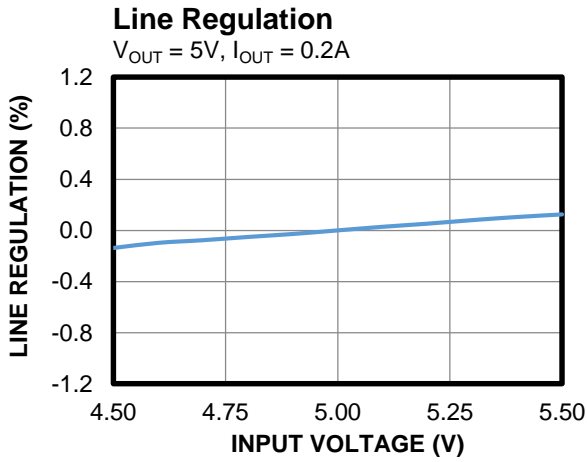

TYPICAL PERFORMANCE CHARACTERISTICS (continued)

$V_{IN} = 5V$ ,  $V_{OUT} = 5V$ ,  $C_{OUT} = 0.1\mu F + 22\mu F$ ,  $T_A = 25^\circ C$ , unless otherwise noted.

**$V_{OUT}$  Ripple**

$I_{OUT} = 0.2A$

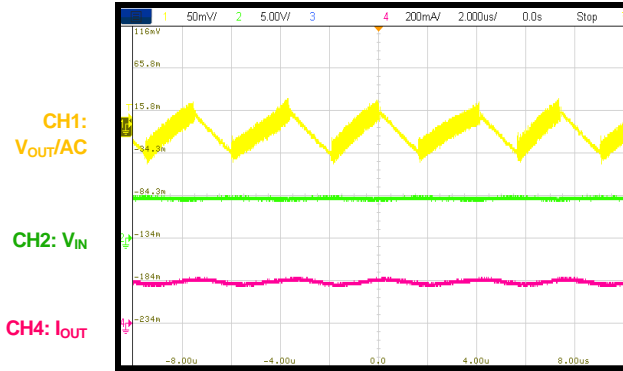

**Load Transient**

$I_{OUT} = 0A$  to  $0.2A$

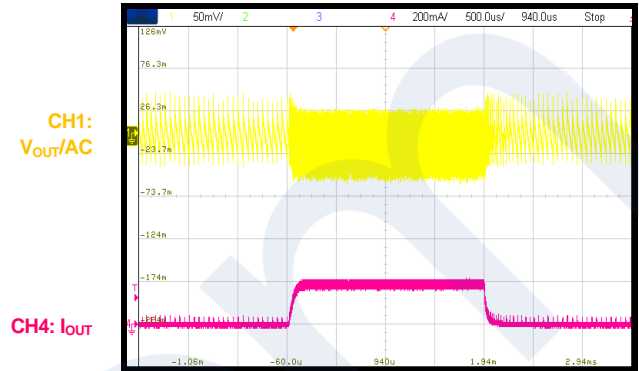

**Start-Up through  $V_{IN}$**

$I_{OUT} = 0.2A$

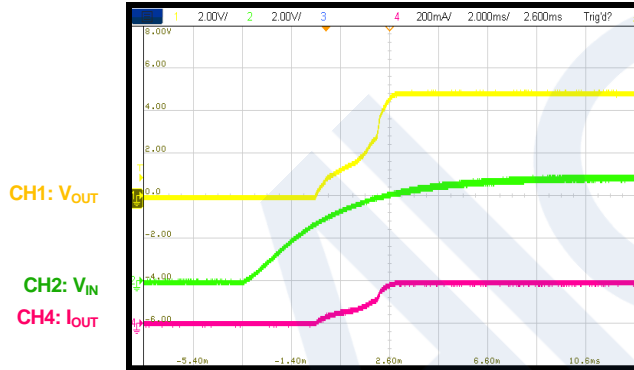

**Shutdown through  $V_{IN}$**

$I_{OUT} = 0.2A$

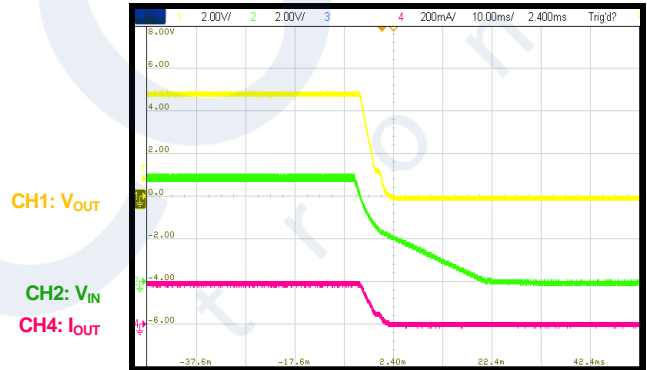

**Start-Up through EN**

$I_{OUT} = 0.2A$

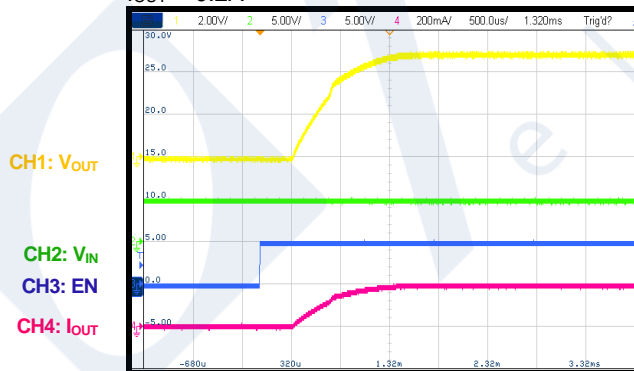

**Shutdown through EN**

$I_{OUT} = 0.2A$

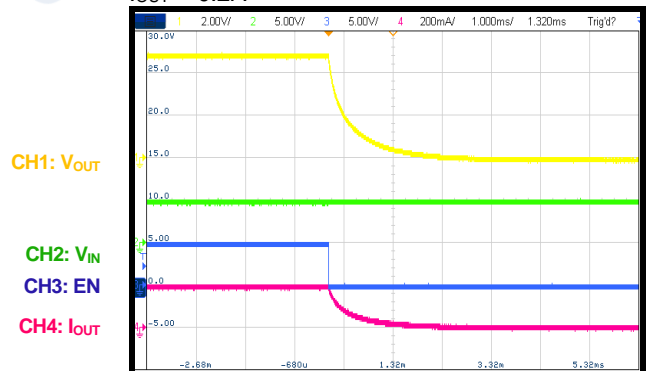

**TYPICAL PERFORMANCE CHARACTERISTICS (continued)**

$V_{IN} = 5V$ ,  $V_{OUT} = 3.3V$ ,  $C_{OUT} = 0.1\mu F + 22\mu F$ ,  $T_A = 25^\circ C$ , unless otherwise noted.

**$V_{OUT}$  Ripple**

$I_{OUT} = 0.2A$

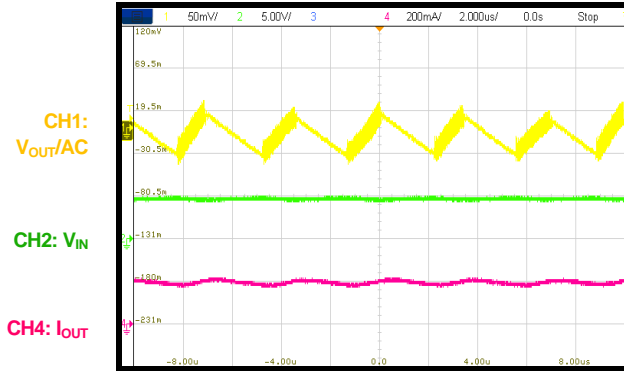

**Load Transient**

$I_{OUT} = 0A$  to  $0.2A$

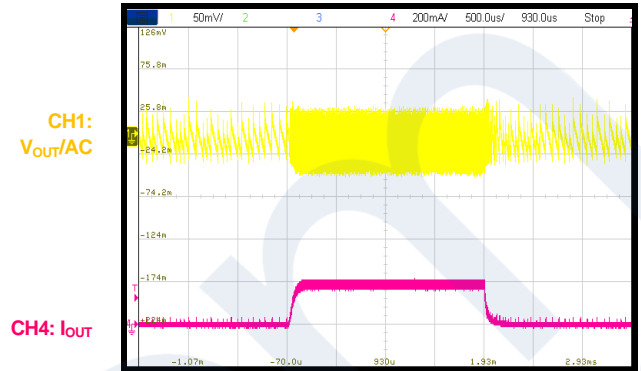

**Start-Up through  $V_{IN}$**

$I_{OUT} = 0.2A$

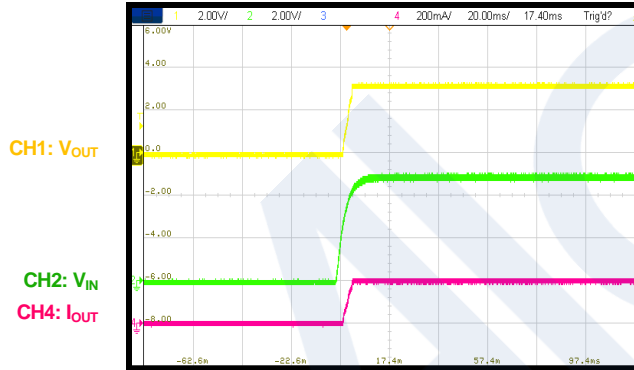

**Shutdown through  $V_{IN}$**

$I_{OUT} = 0.2A$

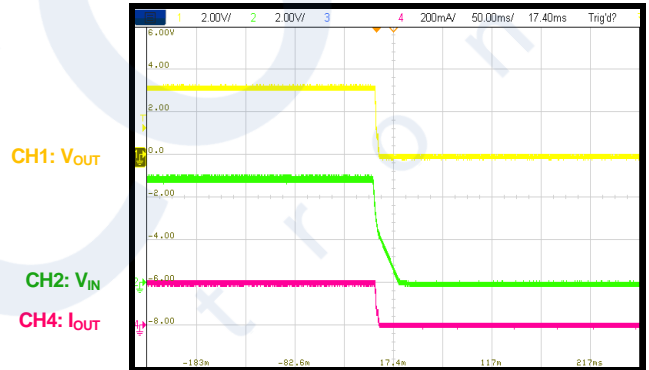

**Start-Up through EN**

$I_{OUT} = 0.2A$

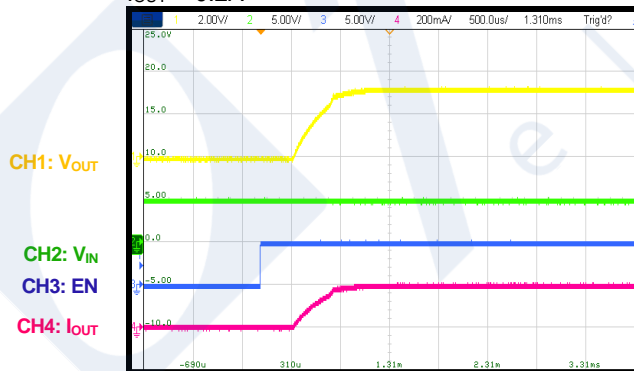

**Shutdown through EN**

$I_{OUT} = 0.2A$

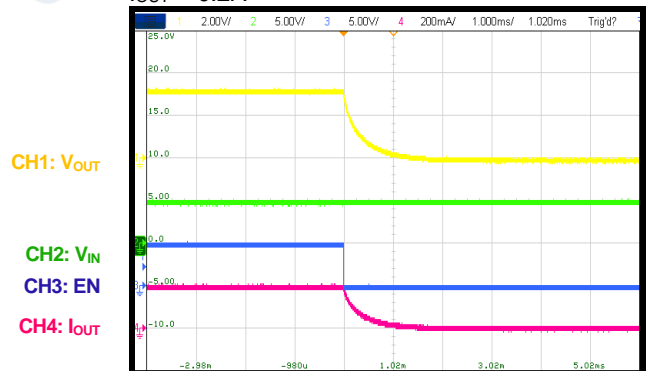

### FUNCTIONAL BLOCK DIAGRAM

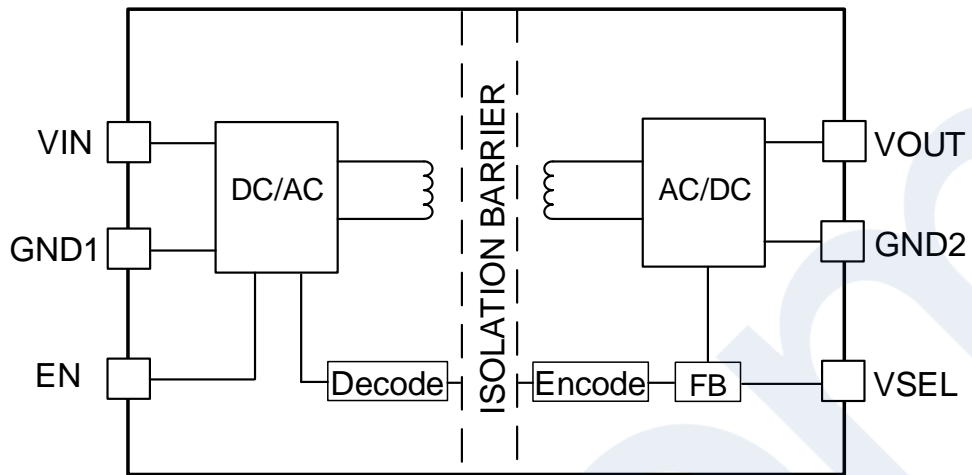

Figure1: Functional Block Diagram

## OPERATION

The MIE1W0505BGLVH is a regulated, isolated DC to DC module. It can support 3V to 5.5V input voltage application, in the  $-40^{\circ}\text{C}$  to  $125^{\circ}\text{C}$  operation temperature. It has excellent load regulation, line regulation performance, supporting up to 1W output power.

### Isolation Power Converting

MIE1W0505BGLVH integrated power MOS, transformer and feedback circuit all in one chip, achieving excellent performance and saving size.

When  $V_{\text{OUT}}$  is lower than the target output voltage, IC will start switching to delivery power from  $V_{\text{IN}}$  to  $V_{\text{OUT}}$ . On the other hand, if  $V_{\text{OUT}}$  rise to target output voltage, switching will stop.

### Output Voltage Setting

Connect VSEL pin to VOUT or float VSEL pin, output voltage is setting to 5V. VOUT can output 200mA load with 4.5V to 5.5V input range.

Connect VSEL pin to GND2, output voltage is setting to 3.3V. VOUT can output 200mA load with 4.5V to 5.5V input range or 75mA load with 3V to 3.6V input range. VSEL logic is locked during startup. After startup, output voltage is fixed even change VSEL logic.

### Under-Voltage Lockout Protection (UVLO)

The MIE1W0505BGLVH has input under-voltage lockout protection (UVLO) to ensure reliable output power. The MIE1W0505BGLVH is powered on when the input voltage exceeds the UVLO rising threshold. The device is powered off when the input voltage drops below the UVLO falling threshold. This function prevents the device from operating at an insufficient voltage. It is a non-latch protection.

### Power Enable (EN)

EN pin enables and disables the MIE1W0505BGLVH. When applying a voltage higher than 2V and input voltage is higher than  $V_{\text{IN}}$  UVLO, MIE1W0505BGLVH will enables all functions and starts switching operation. Switching operation is disabled when EN voltage falls below its lower threshold and shutdown when  $\text{EN} < 0.4\text{V}$ . For automatic startup, connect EN pin to  $V_{\text{IN}}$  directly or through resistor divider.

### Power Converter Soft Startup and SCP

To avoid overshoot and inrush current during start-up, the MIE1W0505BGLVH has built-in an internal soft start (SS) that limits output current from low to high gradually.

MIE1W0505BGLVH startup with constant current (CC) charging mode, in this mode, current limit will fold back, output will CC charge the output capacitor until output voltage rise to about 2.7V. After CC charging period, MIE1W0505BGLVH's current limit back to normal, and with higher output current capability. Such features guarantee infinite capacitive load.

During over load or output short circuit condition, the output voltage drops due to internal current limit. Once  $V_{\text{OUT}}$  drops below about 2.2V, MIE1W0505BGLVH enters CC charging mode. After over current or short circuit condition removed, MIE1W0505BGLVH will resume normal operation when  $V_{\text{OUT}}$  rises to about 2.7V.

### Over Temperature Protection

MIE1W0505BGLVH integrates one temperature monitor circuit. Once junction temperature is higher than  $150^{\circ}\text{C}$ , MIE1W0505BGLVH shuts down. After the temperature drops to lower  $130^{\circ}\text{C}$ , the power supply resumes normal operation again.

## APPLICATION INFORMATION

### Input and Output Capacitor

For stable operation, decoupling capacitors are required between VIN and GND1 pins at the input side, and between VOUT and GND2 pins at the output side. The decoupling capacitors must be placed as closed to VIN and VOUT pins as possible. It's recommended to add 10uF + 0.1uF ceramic capacitor at input and add 22uF + 0.1uF ceramic capacitor at output side, the larger one is used to make the ripple suitable, the smaller one is used to high frequency noise filtering.

### PCB Layout Guidelines

PCB layout is very important for normal operation. Refer to figure 2 and PCB layout guide lines.

- 1) For safety concern, primary side and secondary side must be physically separated. And the creepage/clearance must meet the standard for a certain application.
- 2) Minimize the loop area between VIN, input capacitor and GND1; VOUT, output capacitor and GND2 to minimize the output noise.
- 3) Place enough copper and via on GND1 pins to improve IC thermal performance; it's not recommended to place large copper on GND2 and VOUT pins, otherwise, it will make the EMI worse. The smaller of the copper on VOUT and GND2, the better EMI performance.
- 4) A four layer PCB is recommended for good EMI performance. Because it's easy to build a low ESL overlap Y-CAP and EMI noise will be bypassed. Place sufficient and intensive via on GND1 and GND2 to reduce overlap Y-CAP's ESL. Refer to Figure 2's Mid-layer 2 and Mid-layer 3.
- 5) An external Y-CAP option is recommended to add for EMI debug, SMD package is better than the one with lead due to lower ESL.

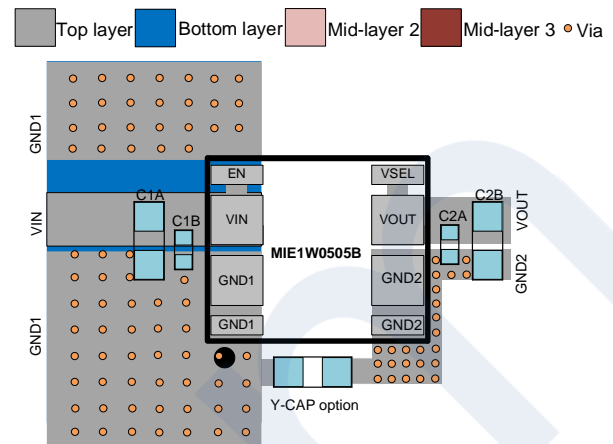

Top Layer and Bottom Layer

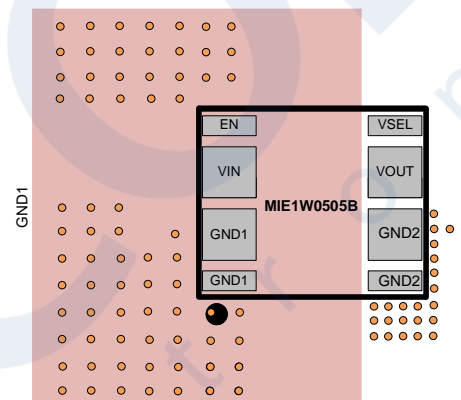

Mid-Layer 2

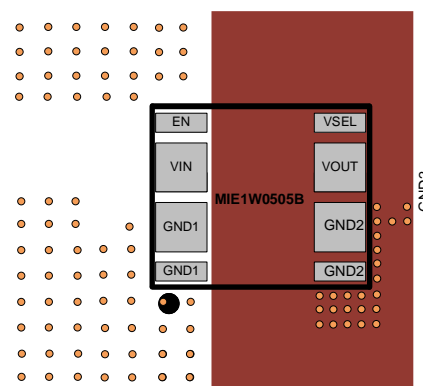

Mid-Layer 3

**Figure 2: Recommended PCB Layout**

### TYPICAL APPLICATION CIRCUITS

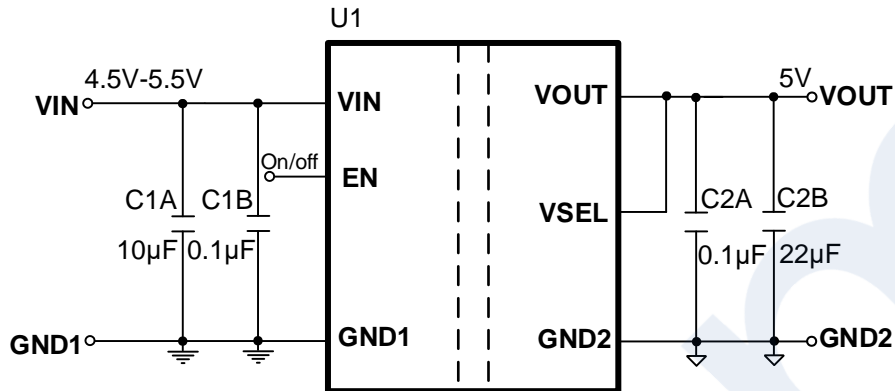

Figure 3: 5V Output Application Circuit

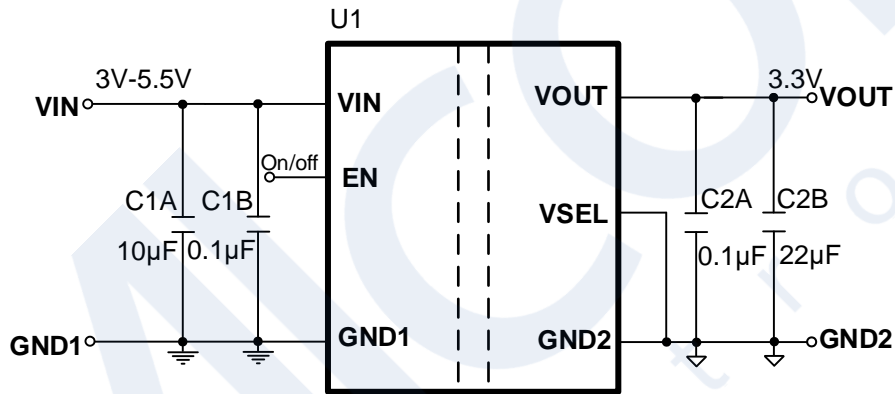
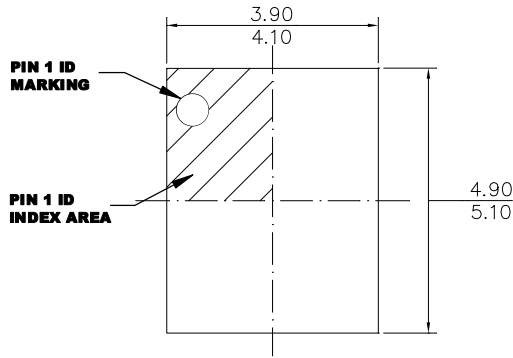

Figure 4: 3.3V Output Application Circuit

**PACKAGE INFORMATION**

**LGA-12 (4mmx5mm)**



**TOP VIEW**

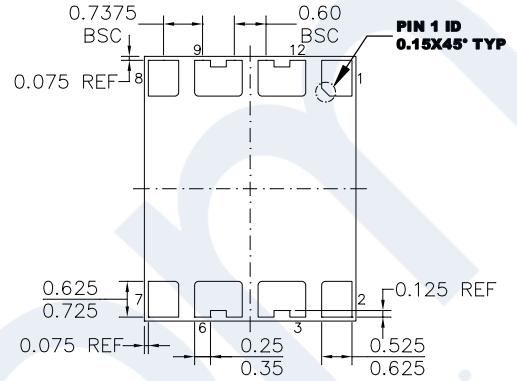

**BOTTOM VIEW**

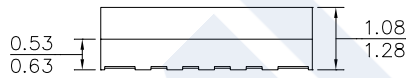

**SIDE VIEW**

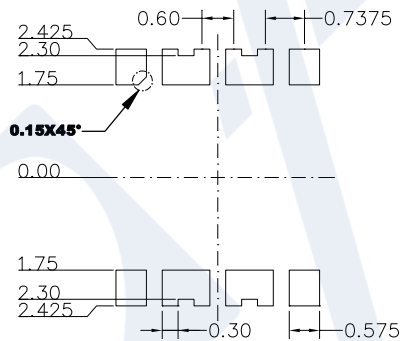

**RECOMMENDED LAND PATTERN**

**NOTE:**

- 1) ALL DIMENSIONS ARE IN MILLIMETERS.**
- 2) LEAD COPLANARITY SHALL BE 0.10 MILLIMETERS MAX.**
- 3) JEDEC REFERENCE IS MO-303.**
- 4) DRAWING IS NOT TO SCALE.**



### CARRIER INFORMATION

#### LGA-12 (4mmx5mm)

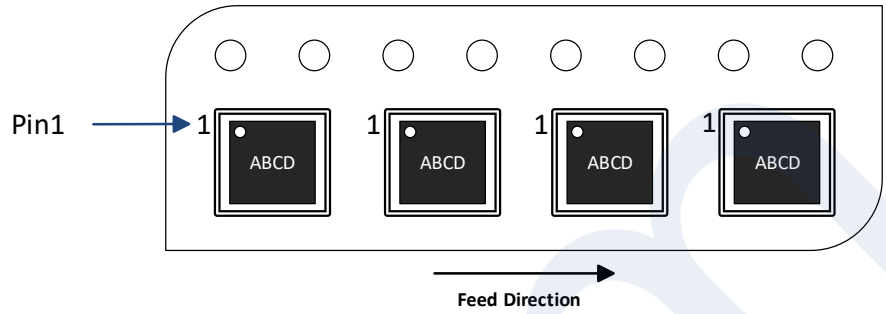
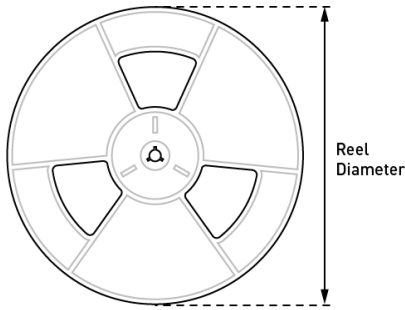

Part Number	Package Description	Quantity /Reel	Quantity /Tube	Quantity /Tray	Reel Diameter	Carrier Tape Width	Carrier Tape Pitch
MIE1W0505BGLVH-3R-Z	LGA-12 (4mmx5mm)	2500	N/A	N/A	13in.	12mm	8mm

**NOTICE:** The information in this document is subject to change without notice. Please contact MPS for current specifications. Users should warrant and guarantee that third-party Intellectual Property rights are not infringed upon when integrating MPS products into any application. MPS will not assume any legal responsibility for any said applications.