

SST-10-IR

Surface Mount Series

Infrared LED

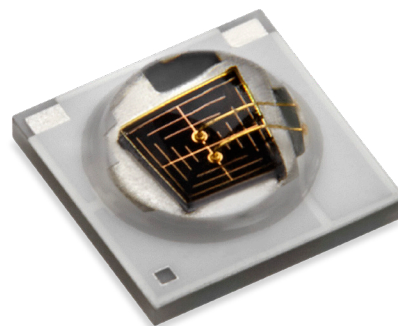

Table of Contents

Technology Overview	2
Product Binning	3
Ordering Information	3
Optical and Electrical Characteristics	4
B130 - Mech. Dimensions	6
B130 - Tape and Reel	7
B90 - Mech. Dimensions	8
B90 - Tape and Reel	9
Solder Profile	10
Precautions	11
Revision History	12

Features

- High Power Infrared LED
- Low Thermal Resistance
- Suitable for all SMT Assembly Methods
- ESD Protection
- RoHS and REACH compliant

Applications

- Surveillance Systems / CCTV
- License Plate Scanning
- Automotive Sensing
- Machine Vision
- Night Vision

Technology Overview

Luminus SST-10-IR LEDs benefit from innovations in device technology, chip packaging and thermal management. This suite of technologies give engineers and system designers the freedom to develop solutions both high in power and efficiency.

Reliability

Luminus SST-10-IR LEDs have passed a rigorous suite of environmental and mechanical stress tests, including mechanical shock, vibration, temperature cycling and humidity. They are fully qualified for use in a wide range of high performance and high efficacy applications.

REACH & RoHS Compliance

The Luminus SST-10-IR LED is compliant to the Restriction of Hazardous Substances Directive or RoHS. The restricted materials including lead, mercury cadmium hexavalent chromium, polybrominated biphenyls (PBB) and polybrominated diphenyl ether (PBDE) are not used.

Understanding Luminus SST-10-IR LED Test Specifications

Every Luminus LED is fully tested to ensure it meets the high quality standards customers have come to expect from Luminus products.

Testing Temperature

Luminus SST-10-IR LEDs are tested and binned at 25°C junction temperature. Temperature curves are provided to allow users to scale the data for actual operating temperature conditions.

Product Ordering and Shipping Part Number Nomenclature

All SST-10-IR products are packaged and labeled with part numbers as outlined in below. When shipped, each reel will contain only a single flux wavelength and Vf bin. The part number designation is as follows:

SST — **10** — **CC** — **B###** — **F###-00**

Product Family	Chip Area	Color	Package Configuration	Bin Kit ^{1,2}
SST - Ceramic Surface Mount package w/ encapsulation	10: 1 mm ²	IR = Infrared	B130 - 130deg Beam Angle B90 - 90 deg Beam Angle Ceramic 3.45mm x 3.45mm See Pages 6-7 for Detailed Drawings	See below for flux and wavelength binning information

Peak Wavelength	Minimum Flux Bin (mw)	Lens Angle	Ordering Part Number
850	265	130	<i>SST-10-IR-B130-K850-00</i>
850	265	90	<i>SST-10-IR-B90-K850-00</i>
940	205	130	<i>SST-10-IR-B130-H940-00</i>
940	205	90	<i>SST-10-IR-B90-H940-00</i>

Flux Bins¹

Bin Code	Minimum Flux (mw)	Maximum Flux (mw)
H	205	235
J	235	265
K	265	295
L	295	325
M	325	355
N	355	385

Wavelength Bins¹

Bin Code	Minimum Peak Wavelength (nm)	Maximum Peak Wavelength (nm)
850	840	870
940	925	955

Optical and Electrical Characteristics

Optical and Electrical Characteristics¹

Parameter	Symbol	Package Type				Unit
		B130-850	B90-850	B130-940	B90-940	
Forward Current	I_f	350	350	350	350	mA
Output Power Typical	PO	280	280	225	225	mw
Min Voltage ¹	V_{fmin}	1.2	1.2	1.2	1.2	V
Forward Voltage Typical	V_f	1.5	1.5	1.4	1.4	V
Max Voltage ¹	V_{fmax}	2.0	2.0	2.0	2.0	V
Viewing Angle	$2\ \varnothing_{1/2}$	130	90	130	90	deg
Peak Wavelength Typical	λ_p	850	850	940	940	nm
FWHM Typical	$\Delta\lambda_{1/2}$	30	30	30	30	nm
Thermal Resistance (Electrical)	R_{TH}	5.3	5.3	5.3	5.3	°C/W

Absolute Maximum Ratings²

Parameter	Symbol	Rating	Unit
Forward Current ^{3,4}	I	1.5	A
Power Dissipation	P _D	3.0	W
Reverse Voltage	V _R	5	V
Storage Temperature	T _{STG}	-40~100	°C
Junction Temperature ^{3,4}	T _J	115 °C	°C
Soldering Temperature	T _{SLD}	JEDEC 020 , 260 °C	
ESD Sensitivity (HBM)	V _B	6000	V

Note 1: Binning based on operation at a current of 350mA and a constant junction temperature of $T_j = 25^\circ\text{C}$. Parts are binned and shipped in 0.2V V_f increments.

Note 2: To prevent damage refer to operating conditions and derating curves for appropriate maximum operating conditions

Note 3: Luminus SST-10-IR LEDs are designed for operation up to an absolute maximum forward drive current as specified above. Product lifetime data is specified at typical forward drive currents. Sustained operation at absolute maximum currents will result in a reduction of device lifetime compared to typical forward drive currents. Actual device lifetimes will also depend on junction temperature.

Note 4: Maximum operating case temperature combined with maximum drive current defines the total maximum operating condition for the device. To prevent damage, please operate devices within specified conditions.

Note 5: Caution must be taken not to stare at the light emitted from these LEDs. Under special circumstances, the high intensity could damage the eye.

Optical and Electrical Characteristics

Relative Output Flux vs. Forward Current

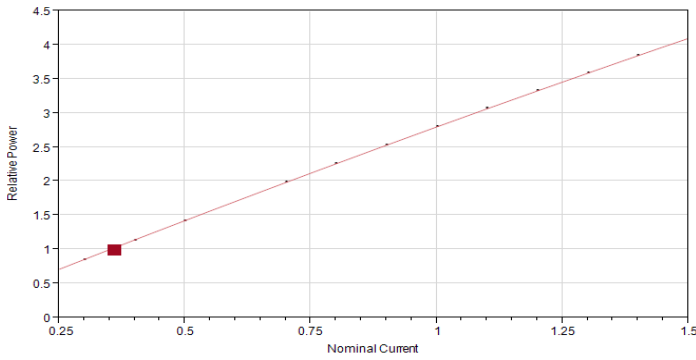

Relative Voltage vs Forward Current

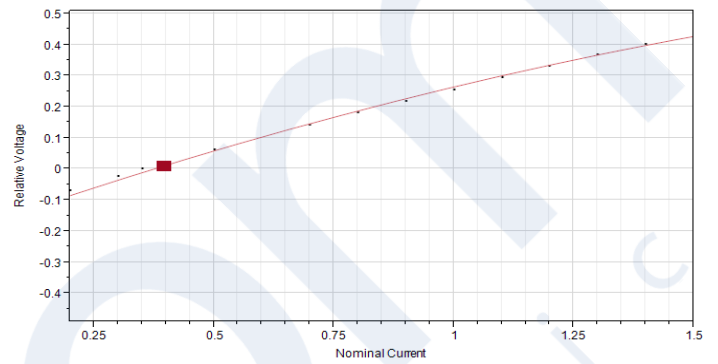

Relative Output Flux vs. Temperature

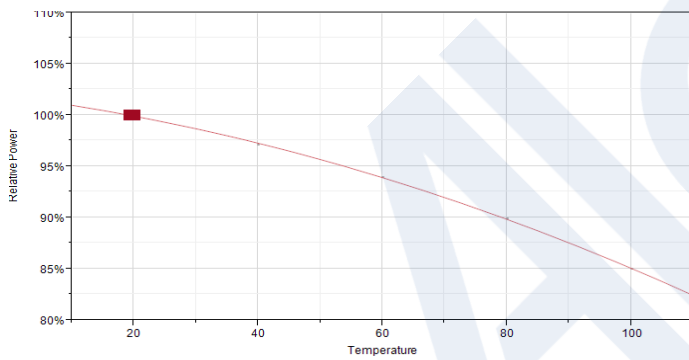

Typical Spectra

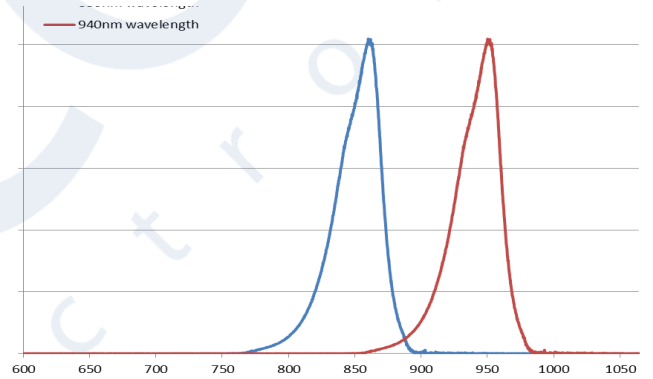

Typical Polar Radiation Plot - B130

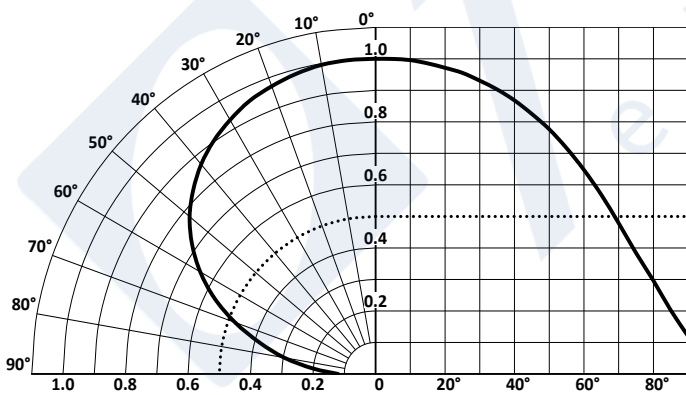

Typical Polar Radiation Plot - B90

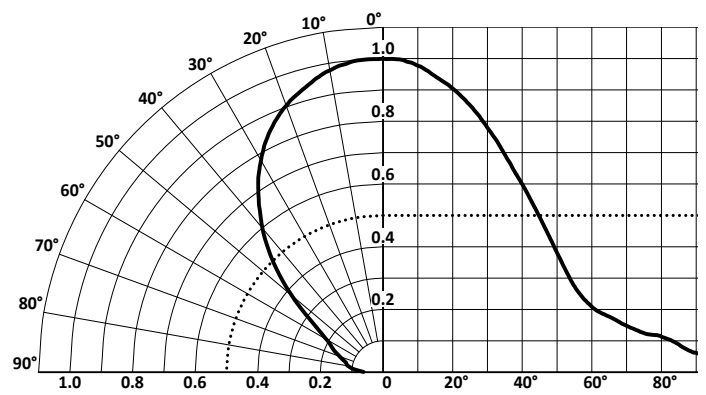

Mechanical Dimensions - B130 Package

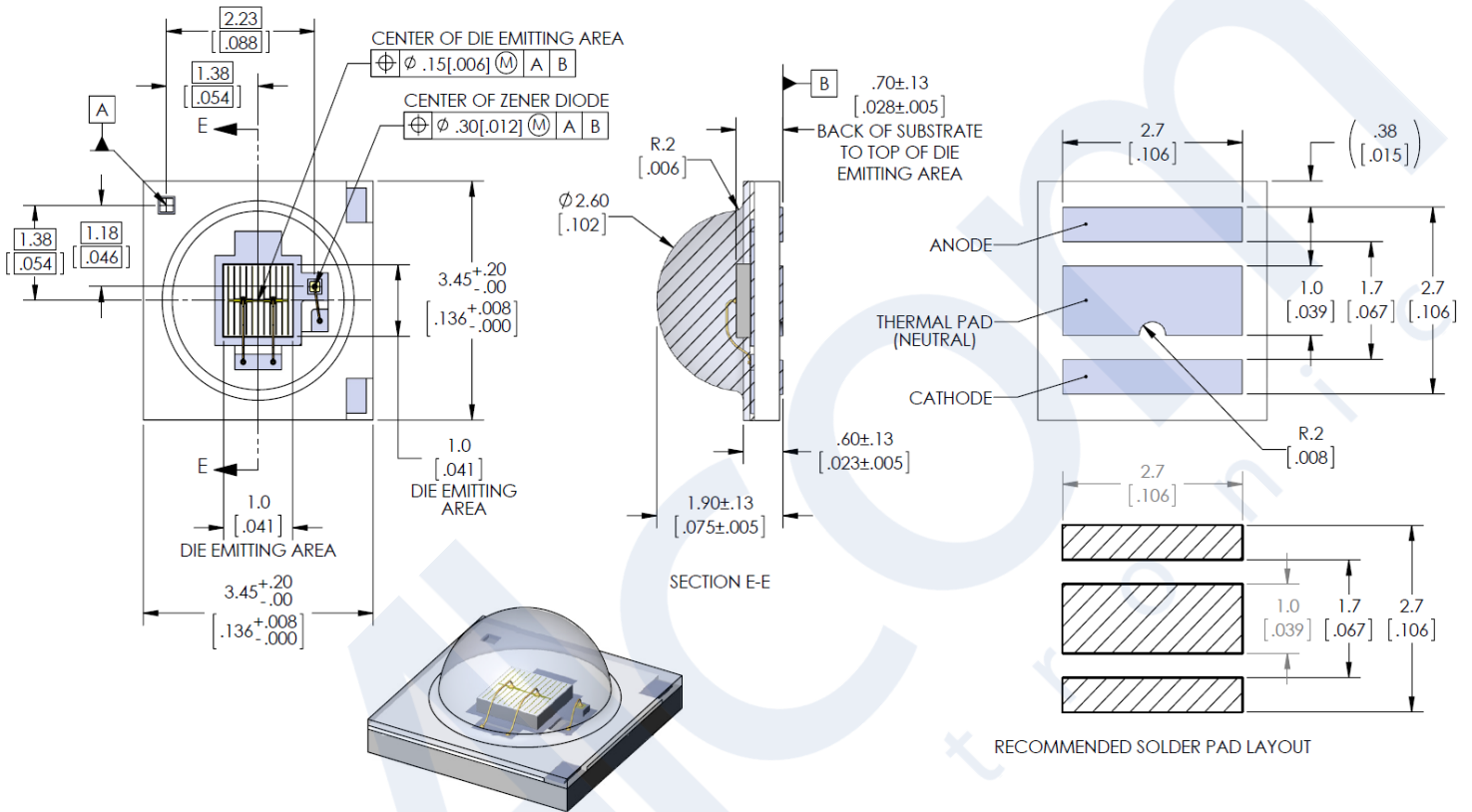

Tape and Reel - B130 Package

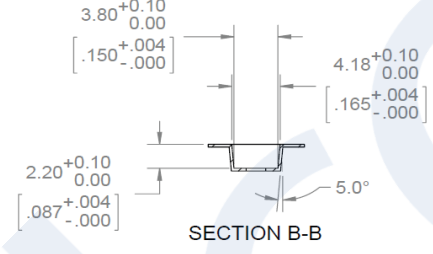
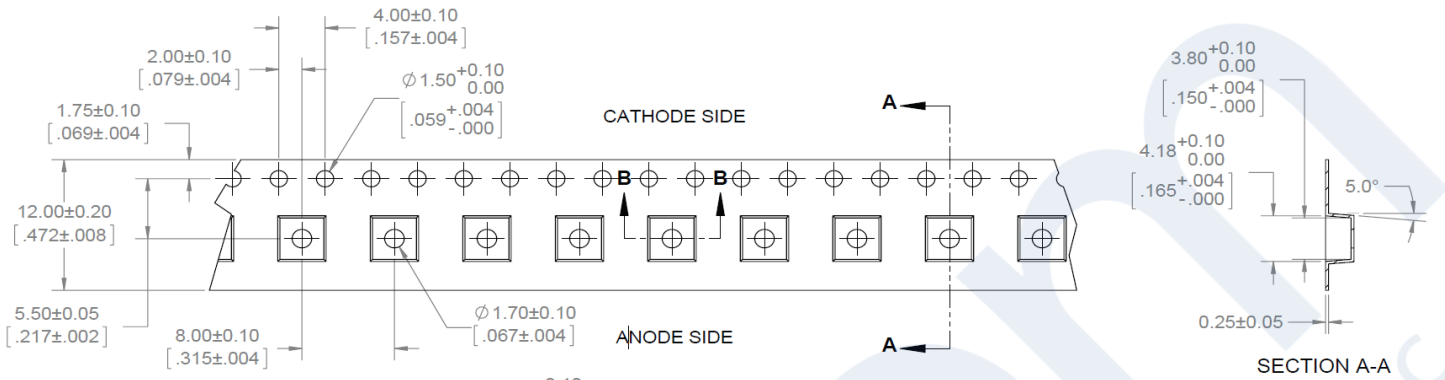

- NOTES:**
1. FINAL TAPE AND REEL PACKAGING MUST MEET THE REQUIREMENTS OF JEDEC-STD-033, LEVEL 2A.
 2. LEAVE 304.8mm [12.00 in] OF TAPE EMPTY FOR LEAD IN (38 EMPTY POCKETS).
 3. LEAVE 457.2mm [18.00 in] OF TAPE EMPTY FOR TRAILER (57 EMPTY POCKETS).
 4. MUST COMPLY TO EIA-481-C-2003

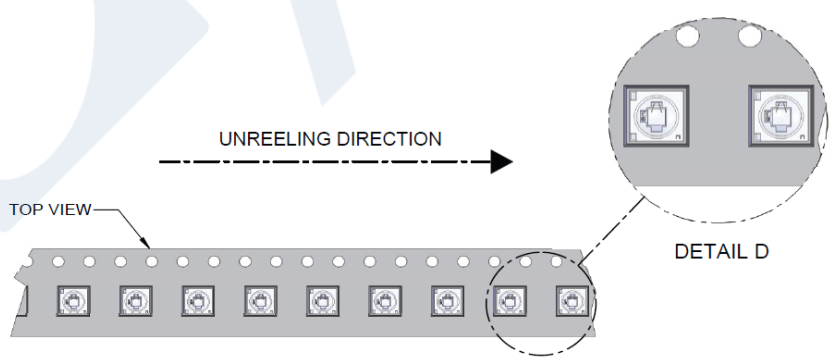
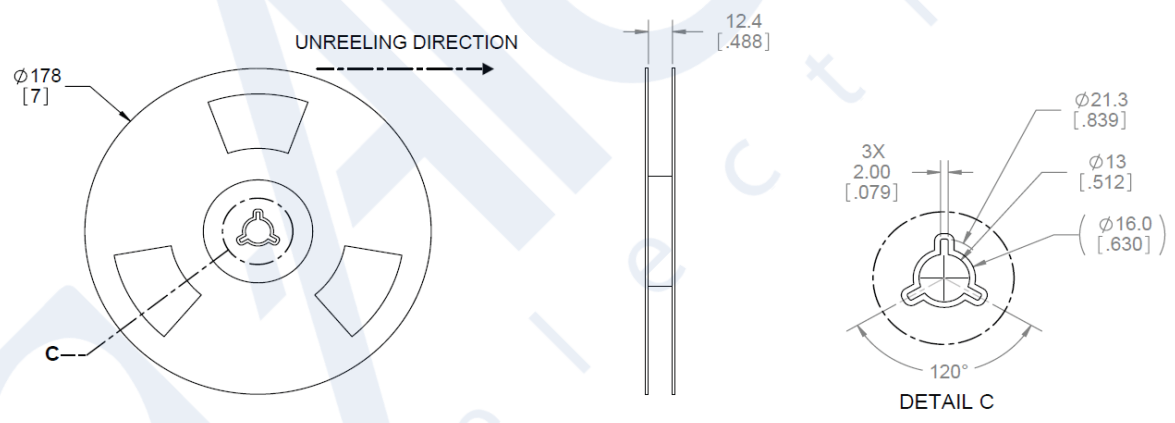

Mechanical Dimensions - B90 Package

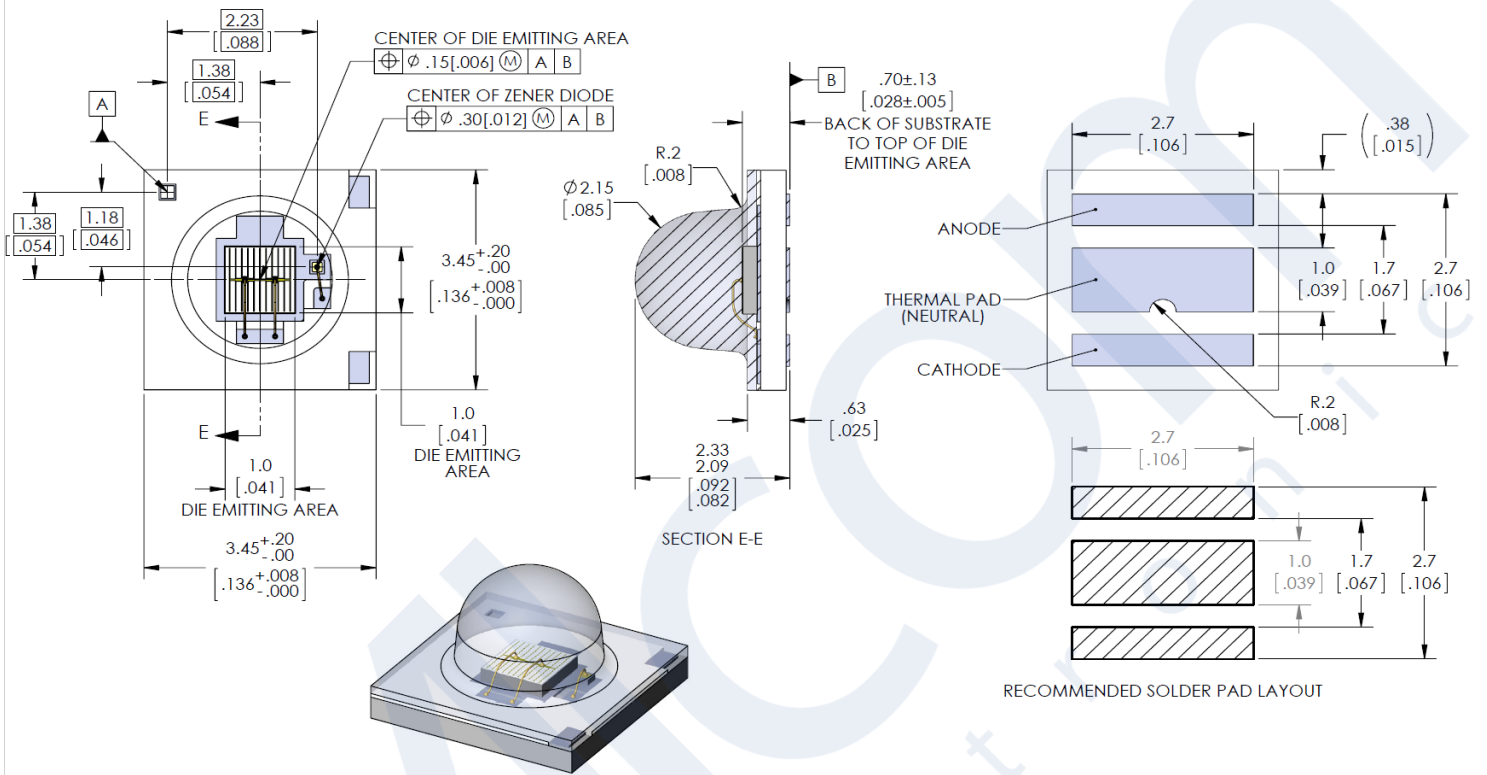

Tape and Reel - B90 Package

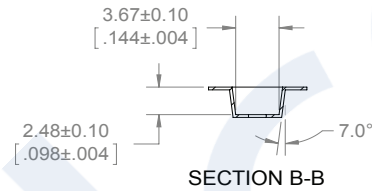
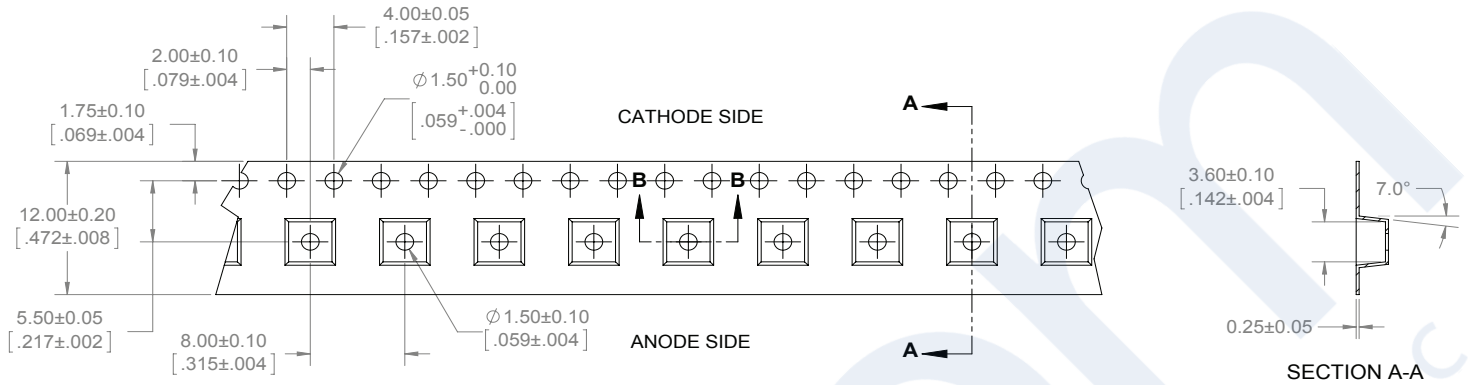

NOTES:

1. FINAL TAPE AND REEL PACKAGING MUST MEET THE REQUIREMENTS OF JEDEC-STD-033, LEVEL 2A.
2. LEAVE 304.8mm [12.00 in] OF TAPE EMPTY FOR LEAD IN (38 EMPTY POCKETS).
3. LEAVE 457.2mm [18.00 in] OF TAPE EMPTY FOR TRAILER (57 EMPTY POCKETS).
4. MUST COMPLY TO EIA-481-C-2003

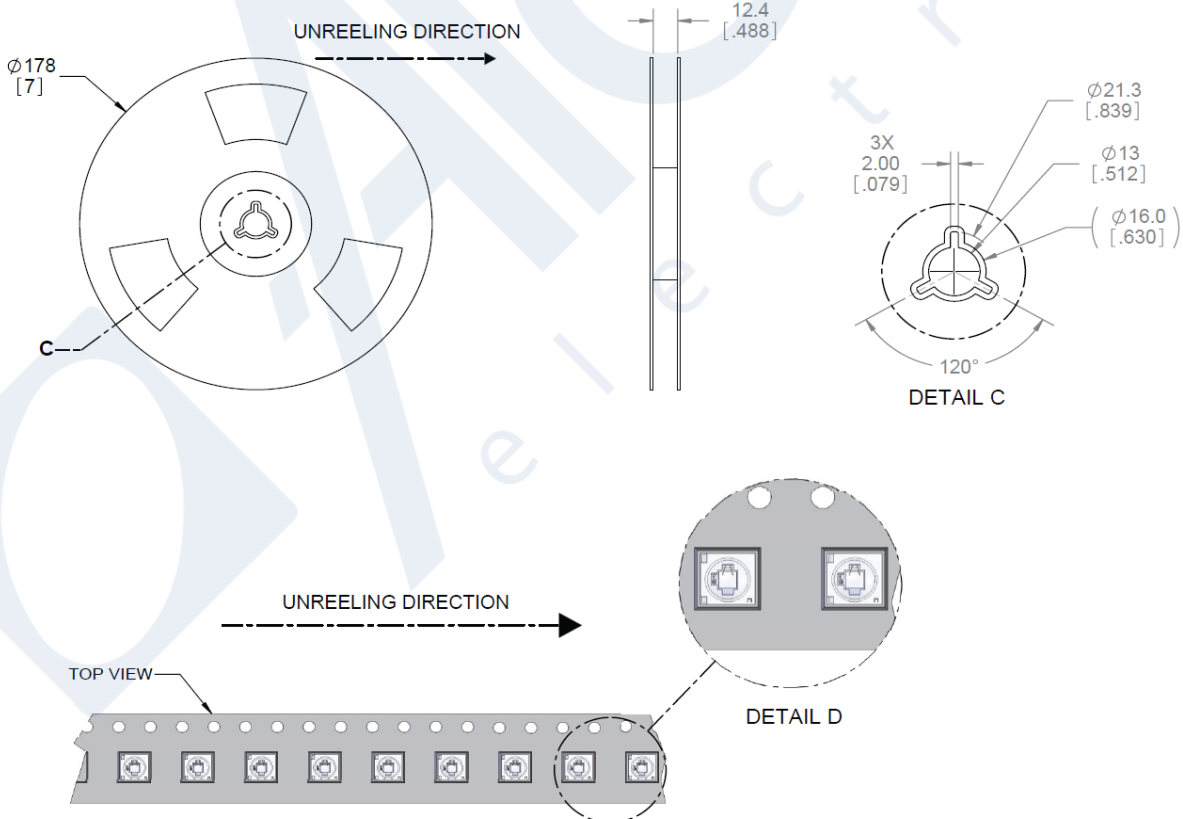

Solder Profile

Moisture Sensitivity Level			
MSL	3		
Profile Feature	Process Window	Time	Average ramp-up rate
Preheat	65°C - 200°C	120 - 250 sec	1 - 2.5°C/sec
Soak			0.4 - 1°C/sec
Reflow Spike	180°C - $T_L + 20^\circ\text{C}$	N/A	3 - 6°C/sec
Cool Down	T_p to below 150°C	N/A	3 - 7°C/sec
Liquidus Temperature (T_L)	220°C		
Time Above Liquidus	45 - 90sec		
Peak Temperature	235 - 245°C		
SMT Rework Guideline	Manual Hotplate Reflow	Hot Air Gun Reflow	
Heating Time	< 60 sec		
Hotplate Temperature	< 230°C	< 150°C	

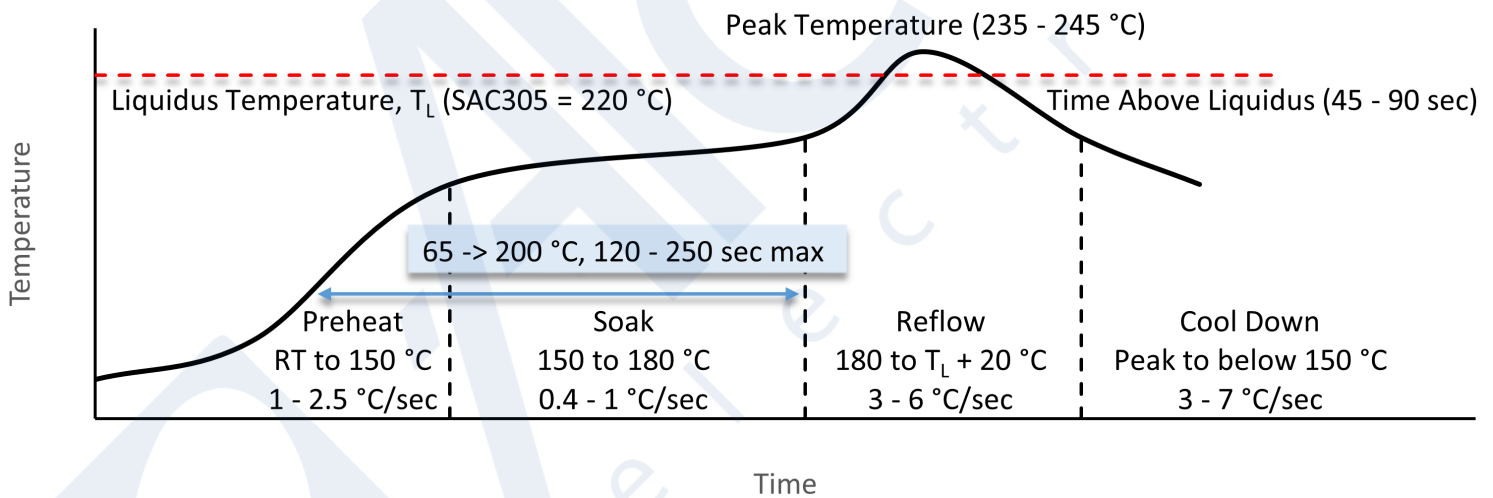

Note 1: The numbers in the table are specific to SAC305. Luminus recommends using an SAC305 solder paste with a no-clean flux for RoHS compliant products.

Note 2: During the pick and place process, axial forces on the dome (or window) should not exceed 0.5 Newtons (N).

Note 3: Use of a multi-zone IR reflow oven with a nitrogen blanket is recommended.

Note 4: Time-temperature profile of the reflow process showing the four functional profile zones are defined in IPC-7801. Temperature is referenced to the center of the PCB.

Note 5: Luminus recommends to use the solder paste data sheet information as a starting point in time-temperature process development.

Note 6 These are general guidelines. Consult the solder paste manufacturer's datasheet for guidelines specific to the alloy and flux combination used in your application. Product complies to MSL Level 3. For more information, please refer to:

<https://luminusdevices.zendesk.com/hc/en-us/articles/360060306692-How-do-I-Reflow-Solder-Luminus-SMD-Components->

Note 7: For any technical questions about soldering process, please contact Luminus at techsupport@luminus.com.

Precautions for Use

Storage:

1. Before opening the package

Unopened LEDs bags should be kept at a temperature between 15°C & 40°C and should be used within a year.

2. After opening the package

Opened LED moisture proof packages should be stored between 30 and 60% RH. The LEDs should be soldered within 168 hours (7days) after opening the package.

If unused LEDs remain on a reel, they should be stored in resealable moisture proof packages with new absorbent material (silica gel) and new moisture indicator cards, or better, in a dry box. If the moisture card indicates, or the first article run of the LEDs popcorns, an oven baking treatment should be performed using the following conditions: 60°C for 20 hours.

The LED electrodes and lead frames may incorporate a silver-plated copper alloy. These can be identified by a silver appearance (compared to a gold appearance). This silver surface may be affected by environmental contaminants, particularly sulfur containing compounds, during storage, and at the point of use. Please avoid conditions which may cause the LEDs to become corroded or discolored. Corrosion or discoloration can reduce solderability and/or affect optical characteristics.

Avoid rapid temperature transitions, especially in high humidity environments where condensation can occur.

Static Electricity:

These products are sensitive to static electricity, and care should be taken when handling them. Static electricity or surge voltage will damage the LEDs. It is recommended to wear an anti-electrostatic wristband or anti-electrostatic gloves when handling the LEDs. All devices, equipment and machinery must be properly grounded. It is recommended that measures be taken to isolate LED processing equipment from potential sources of voltage surges.

Reference: APN-002815 Electrical Stress Damage to LEDs and How to Prevent It

Corrosion Resistance:

Corrosion Test: Class 3B - Test condition: 40°C / 90% RH / 15ppm H₂S / 14 days (stricter than IEC60068 2-43)

History of Changes

Rev	Date	Description of Change
01	01/13/2016	Initial Release
02	03/28/2016	Updated Binning and Angular Distribution Data, Added 90deg Tape and Reel
03	02/08/2022	Update Solder Profile, Precaution for use & add flux bin

The products, their specifications and other information appearing in this document are subject to change by Luminus Devices without notice. Luminus Devices assumes no liability for errors that may appear in this document, and no liability otherwise arising from the application or use of the product or information contained herein. None of the information provided herein should be considered to be a representation of the fitness or suitability of the product for any particular application or as any other form of warranty. Luminus Devices' product warranties are limited to only such warranties as accompany a purchase contract or purchase order for such products. Nothing herein is to be construed as constituting an additional warranty. No information contained in this publication may be considered as a waiver by Luminus Devices of any intellectual property rights that Luminus Devices may have in such information. Big Chip LEDs™ is a registered trademark of Luminus Devices, Inc., all rights reserved.

This product is protected by U.S. Patents 6,831,302; 7,074,631; 7,083,993; 7,084,434; 7,098,589; 7,105,861; 7,138,666; 7,166,870; 7,166,871; 7,170,100; 7,196,354; 7,211,831; 7,262,550; 7,274,043; 7,301,271; 7,341,880; 7,344,903; 7,345,416; 7,348,603; 7,388,233; 7,391,059 Patents Pending in the U.S. and other countries.