

Generation 4

CIM-9 COB Arrays

White LED



Contents

Part Number Nomenclature	2
CCT, CRI & R9 Specification	.2
Chromaticity Bin Structure	.3
Ordering Part Numbers	... 4
Operating Characteristics	..6
Optical and Electrical Characteristics7
Typical Spectrum9
Radiation Pattern9
Mechanical Dimension	... 10
Shipping Container 10
Label Information 10
Technology Review 11
Test Specifications 11
Handling Notes 12

Features:

- High lumen output and efficacy typical
 - Over 825 lm, 135 LPW @ 3000K, 90CRI, $T_j = 85^\circ\text{C}$
 - Over 1,055 lm, 173 LPW @ 5000K, 70CRI, $T_j = 85^\circ\text{C}$
- CCT range 2400K, 2700K, 3000K, 3500K, 4000K, 5000K, 5700K and 6500K
- AccuWhite High Color Rendering, 97CRI Typ. Most CCTs
- 3 SDCM color binning standard, 2 SDCM binning available
- Excellent optical emission uniformity and color over angle consistency
- Exceptional long term color stability
- Superior thermal conductivity for uniform heat spreading
- Environmentally friendly: RoHS and REACH compliant
- UL recognized, file # E465703



Applications

- | | |
|---------------------------|---------------------------------|
| • Spotlights/Track Lights | • Architectural and Specialty |
| • Downlights | • Street Lighting |
| • Shop Lighting | • Parking Lot and Area Lighting |
| • Hospitality Lighting | • Tunnel Lighting |

Part Number Nomenclature

All Luminus COB products are packaged and labeled with part numbers as outlined in the table on page 4. Luminus may include any smaller chromaticity bin that is contained in the larger bin as part of the ordered part. When shipped, each package will contain only a single flux and chromaticity bin. The part number designation is as follows:

CIM	9	NN	XX	VV	QPP	FG	W
Product Family	LES ¹	CCT ²	Min. CRI ³	Typical Voltage	Package Configurator ⁴	Flux Bin	Chromaticity Bin
Chip on Board, Multi-die	9mm LES diameter	See Note 2 below	CRI See Table Below	Volts (V)	AC40	Lumens	See page 3 for bins

Notes:

1. Light Emitting Surface (LES) Diameter.
2. Correlated Color Temperature (CCT), NN nomenclature corresponds to the following:
 - 24 = 2400K
 - 27 = 2700k
 - 30 = 3000k
 - 35 = 3500K
 - 40 = 4000K
 - 50 = 5000K
 - 57 = 5700K
 - 65 = 6000K
3. Minimum Color Rendering Index (CRI).
4. AC is a standard substrate; 4 means Generation 4 COB products, 0 means a product with chromaticity on the BBL.
5. Luminus part numbers may be accompanied by prefixes or suffixes. The most common is the "Rev01" suffix indicating a part is fully released and carries a full warranty. These additional characters may appear on shipping labels, packing slips and invoices. In all cases the basic part number described above will always be included.

CCT, CRI and R9 Values

Correlated Color Temperatures	XX Value	CRI	R9
4000K, 5000K, 5700K, 6500K	70	>70	-
2700K, 3000K, 3500K, 4000K, 5000K, 5700K, 6500K	80	>80	>0
2400K, 2700K, 3000K, 3500K, 4000K, 5000K	90	>90	>50
2700K, 3000K	95	>95	>85
3500K, 4000K, 5000K			>75

Note: R9 values have a tolerance of +/- 5%

Chromaticity Bin Structure

Chromaticity Bins: 1931 CIE Color Space

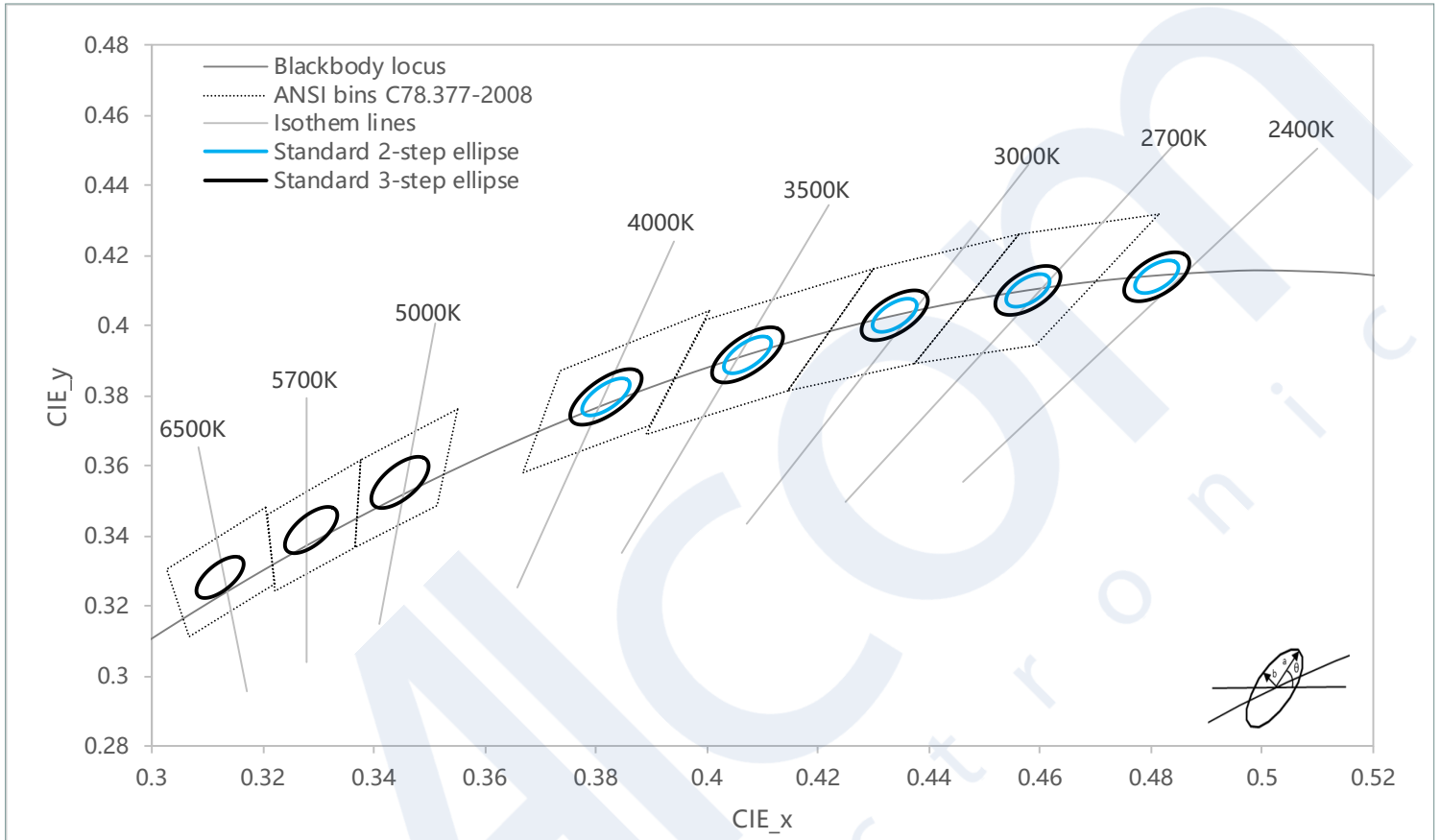

The following tables describe the chromaticity bin center points, the orientation angle for the MacAdam ellipse (θ°), and the maximum radii for the ellipses. The ANSI Bin is provided for reference.

CCT	Center Point		Angle	3-step Bin		2-step Bin	
	CIE _x	CIE _y	θ°	a	b	a	b
2400K	0.481	0.414	53.7	0.0081	0.0042	0.0054	0.0028
2700K	0.4578	0.4101	53.7	0.0081	0.0042	0.0054	0.0028
3000K	0.4338	0.403	53.2	0.00834	0.00408	0.00556	0.00272
3500K	0.4073	0.3917	54	0.00927	0.00414	0.00618	0.00276
4000K	0.3818	0.3797	53.7	0.00939	0.00402	0.00626	0.00268
5000K	0.3447	0.3553	59.6	0.00822	0.00354		
5700K	0.3287	0.3417	59.1	0.00746	0.0032		
6500K	0.3123	0.3282	58.57	0.00669	0.00285		

Note: Luminus maintains a +/- 0.005 tolerance on chromaticity (CIE_x and CIE_y) measurements

Ordering Part Numbers - 36V

The following tables describe products with typical flux and minimum flux measured at 180mA and specified at $T_j = 85^\circ\text{C}$. The values at 25°C are calculated and shown for reference only.

CCT	Output Flux (lm)			Color Rendering Index (min.)	Ordering Part Number	
	Typ. (85°C)	Min. (85°C)	Calculated Typ. (25°C)		3-step MacAdam Ellipse	2-step MacAdam Ellipse
2400K	620	575	680	90	CIM-9-24-90-36-AC40-F5-3	CIM-9-24-90-36-AC40-F5-2
2700K	985	915	1080	80	CIM-9-27-80-36-AC40-F5-3	CIM-9-27-80-36-AC40-F5-2
	790	735	870	90	CIM-9-27-90-36-AC40-F5-3	CIM-9-27-90-36-AC40-F5-2
	685	635	755	95	CIM-9-27-95-36-AC40-F5-3	CIM-9-27-95-36-AC40-F5-2
3000K	975	905	1070	80	CIM-9-30-80-36-AC40-F5-3	CIM-9-30-80-36-AC40-F5-2
	825	765	905	90	CIM-9-30-90-36-AC40-F5-3	CIM-9-30-90-36-AC40-F5-2
	710	660	780	95	CIM-9-30-95-36-AC40-F5-3	CIM-9-30-95-36-AC40-F5-2
3500K	990	920	1090	80	CIM-9-35-80-36-AC40-F5-3	CIM-9-35-80-36-AC40-F5-2
	820	760	900	90	CIM-9-35-90-36-AC40-F5-3	CIM-9-35-90-36-AC40-F5-2
	750	695	825	95	CIM-9-35-95-36-AC40-F5-3	CIM-9-35-95-36-AC40-F5-2
4000K	1030	955	1135	70	CIM-9-40-70-36-AC40-F5-3	CIM-9-40-70-36-AC40-F5-2
	980	910	1080	80	CIM-9-40-80-36-AC40-F5-3	CIM-9-40-80-36-AC40-F5-2
	870	810	955	90	CIM-9-40-90-36-AC40-F5-3	CIM-9-40-90-36-AC40-F5-2
	785	730	865	95	CIM-9-40-95-36-AC40-F5-3	CIM-9-40-95-36-AC40-F5-2
5000K	1055	980	1160	70	CIM-9-50-70-36-AC40-F5-3	
	1000	930	1100	80	CIM-9-50-80-36-AC40-F5-3	
	905	840	995	90	CIM-9-50-90-36-AC40-F5-3	
	785	730	865	95	CIM-9-50-95-36-AC40-F5-3	
5700K	1050	975	1155	70	CIM-9-57-70-36-AC40-F5-3	
	990	920	1090	80	CIM-9-57-80-36-AC40-F5-3	
6500K	980	910	1080	70	CIM-9-65-70-36-AC40-F5-3	
	955	890	1050	80	CIM-9-65-80-36-AC40-F5-3	

Note: Luminus maintains a +/- 6% tolerance on flux measurements.
Luminus maintains a +/- 2% tolerance on CRI measurements.

Ordering Part Numbers - 18V

The following tables describe products with typical flux and minimum flux measured at 360mA and specified at $T_j = 85^\circ\text{C}$. The values at 25°C are calculated and shown for reference only.

CCT	Output Flux (lm)			Color Rendering Index (min.)	Ordering Part Number	
	Typ. (85°C)	Min. (85°C)	Calculated Typ. (25°C)		3-step MacAdam Ellipse	2-step MacAdam Ellipse
2400K	620	575	680	90	CIM-9-24-90-18-AC40-F5-3	CIM-9-24-90-18-AC40-F5-2
2700K	985	915	1080	80	CIM-9-27-80-18-AC40-F5-3	CIM-9-27-80-18-AC40-F5-2
	790	735	870	90	CIM-9-27-90-18-AC40-F5-3	CIM-9-27-90-18-AC40-F5-2
	685	635	755	95	CIM-9-27-95-18-AC40-F5-3	CIM-9-27-95-18-AC40-F5-2
3000K	975	905	1070	80	CIM-9-30-80-18-AC40-F5-3	CIM-9-30-80-18-AC40-F5-2
	825	765	905	90	CIM-9-30-90-18-AC40-F5-3	CIM-9-30-90-18-AC40-F5-2
	710	660	780	95	CIM-9-30-95-18-AC40-F5-3	CIM-9-30-95-18-AC40-F5-2
3500K	990	920	1090	80	CIM-9-35-80-18-AC40-F5-3	CIM-9-35-80-18-AC40-F5-2
	820	760	900	90	CIM-9-35-90-18-AC40-F5-3	CIM-9-35-90-18-AC40-F5-2
	750	695	825	95	CIM-9-35-95-18-AC40-F5-3	CIM-9-35-95-18-AC40-F5-2
4000K	1030	955	1135	70	CIM-9-40-70-18-AC40-F5-3	CIM-9-40-70-18-AC40-F5-2
	980	910	1080	80	CIM-9-40-80-18-AC40-F5-3	CIM-9-40-80-18-AC40-F5-2
	870	810	955	90	CIM-9-40-90-18-AC40-F5-3	CIM-9-40-90-18-AC40-F5-2
	785	730	865	95	CIM-9-40-95-18-AC40-F5-3	CIM-9-40-95-18-AC40-F5-2
5000K	1055	980	1160	70	CIM-9-50-70-18-AC40-F5-3	
	1000	930	1100	80	CIM-9-50-80-18-AC40-F5-3	
	905	840	995	90	CIM-9-50-90-18-AC40-F5-3	
	785	730	865	95	CIM-9-50-95-18-AC40-F5-3	
5700K	1050	975	1155	70	CIM-9-57-70-18-AC40-F5-3	
	990	920	1090	80	CIM-9-57-80-18-AC40-F5-3	
6500K	980	910	1080	70	CIM-9-65-70-18-AC40-F5-3	
	955	890	1050	80	CIM-9-65-80-18-AC40-F5-3	

Note: Luminus maintains a +/- 6% tolerance on flux measurements.
Luminus maintains a +/- 2% tolerance on CRI measurements.

Operating Characteristics¹

Parameter - 36V	Symbol	Minimum	Typical	Maximum	Unit
Forward Current ²	I_f		180	500	mA
Forward Voltage ³	V_f	31.0	33.5	37.0	V

Parameter - 18V	Symbol	Minimum	Typical	Maximum	Unit
Forward Current ²	I_f		360	1000	mA
Forward Voltage ³	V_f	15.5	16.7	18.5	V

Parameter	Symbol	Minimum	Typical	Maximum	Unit
Power			6.1	19.8	W
Operating Case Temperature	T_c			120	°C
Light Emitting Surface Diameter	LES		9.8		mm
Thermal Resistance (junction-to-case)	Θ_{jc}		0.70		°C/W
Junction Temperature	T_j			140	°C
Viewing Angle			120		Degree

Notes:

1. Ratings are based on operation at a constant junction temperature of $T_j = 85^\circ\text{C}$.
2. To prevent damage refer to operating conditions and derating curves for appropriate maximum operating conditions
3. Voltage is rated at typical forward current. For voltage at higher drive current, refer to performance graphs.
4. Device operation not recommended at drive currents less than 10% of the typical value
5. Caution must be taken not to stare at the light emitted from these LEDs. Under special circumstances, the high intensity could damage the eye.
6. All product operating specifications are subject to change without advance notice.

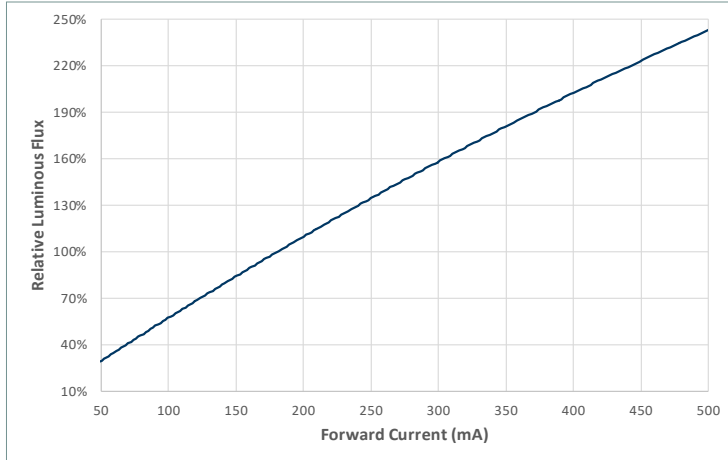
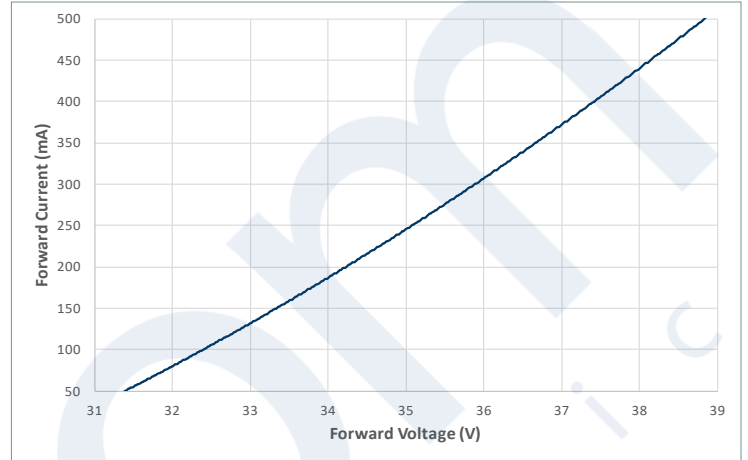
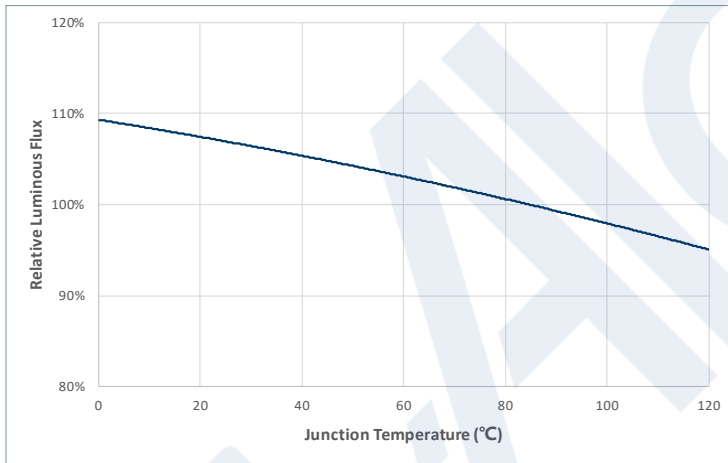
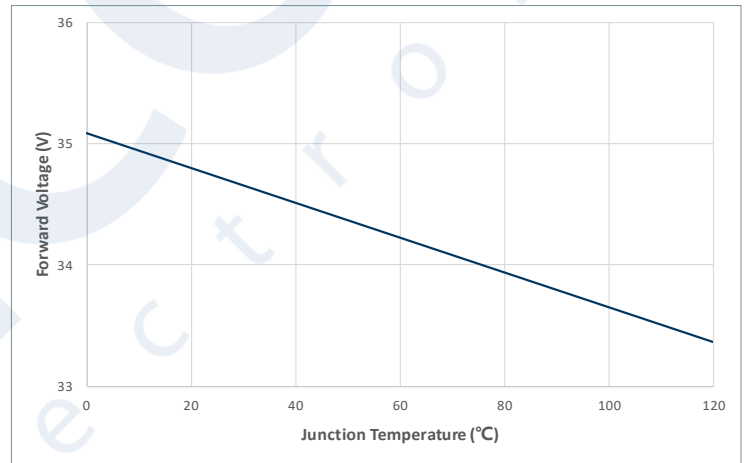
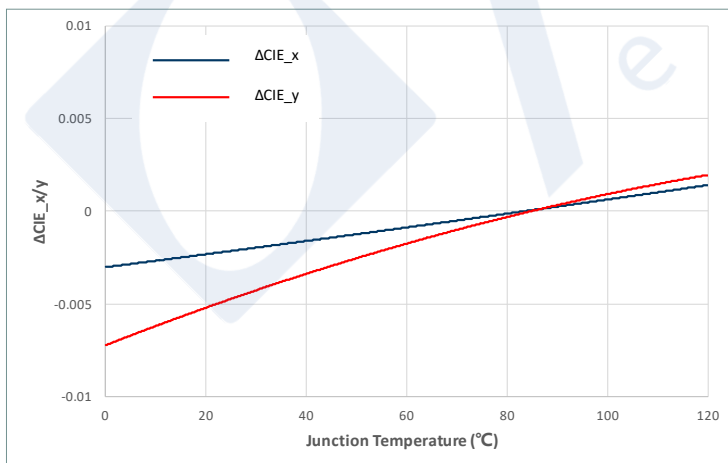
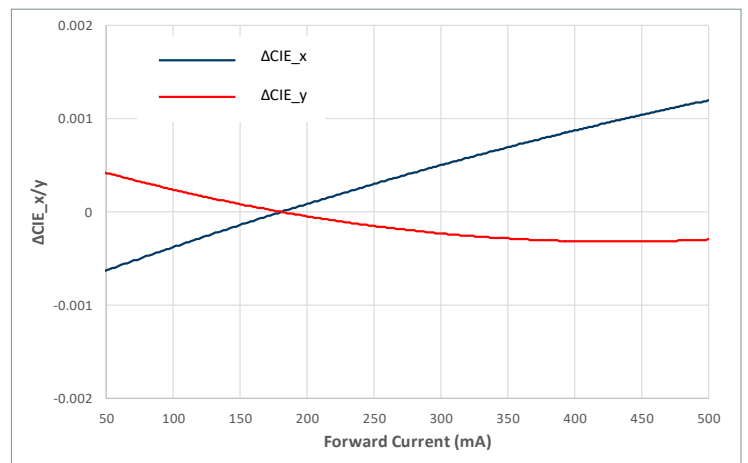
Optical & Electrical Characteristics - 36V
Relative Output Flux vs. Forward Current @ 85°C

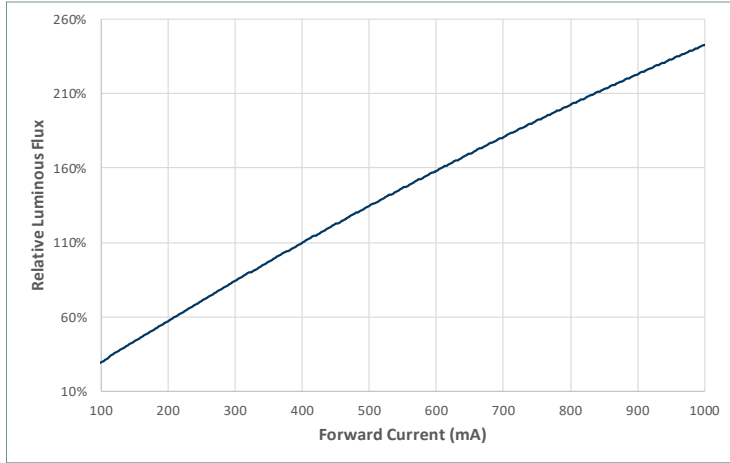
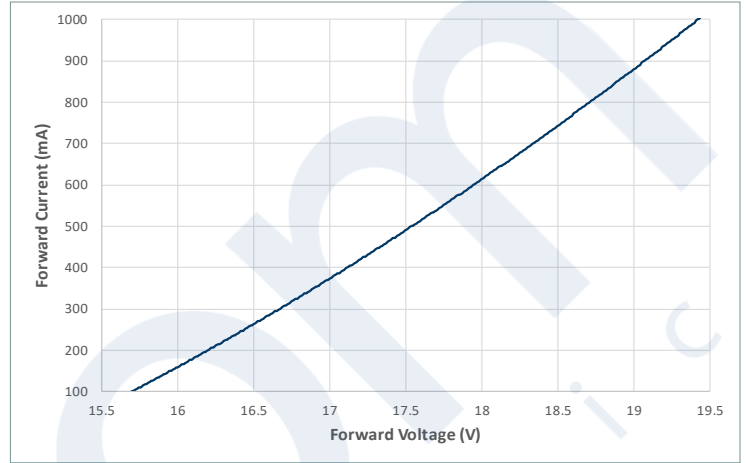
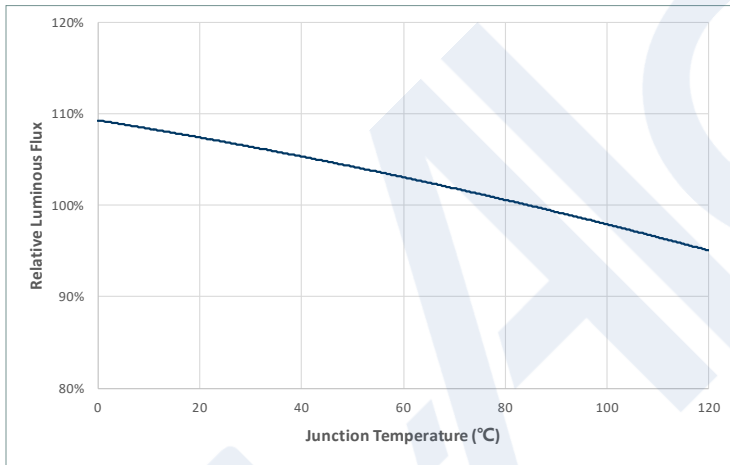
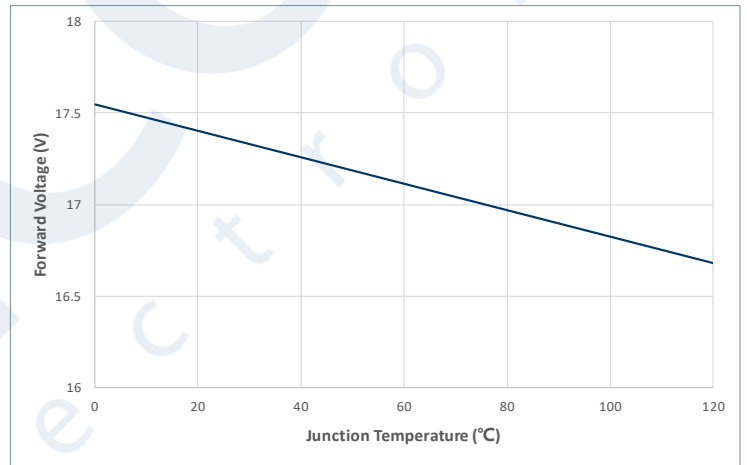
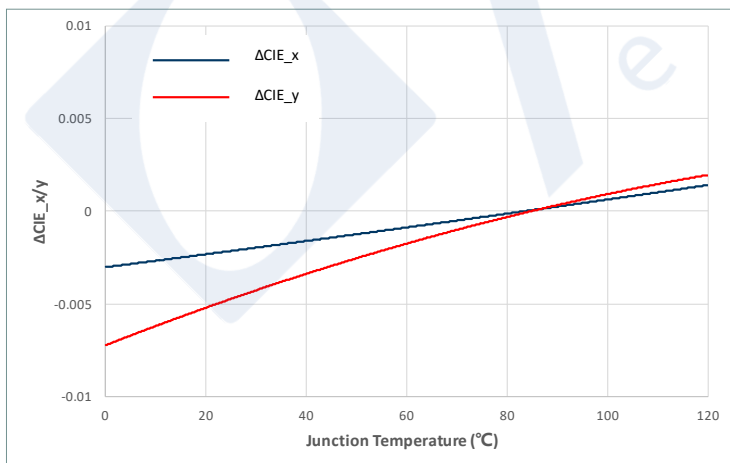
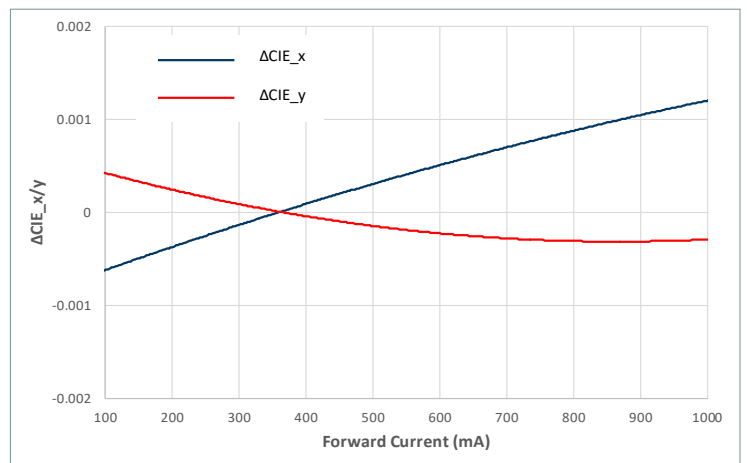
Forward Current vs. Forward Voltage @ 85°C

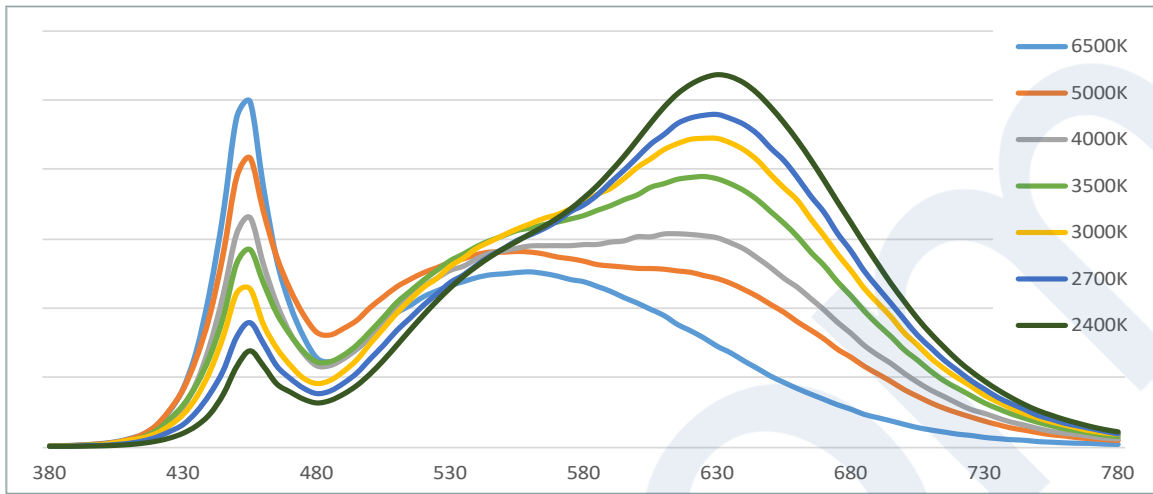
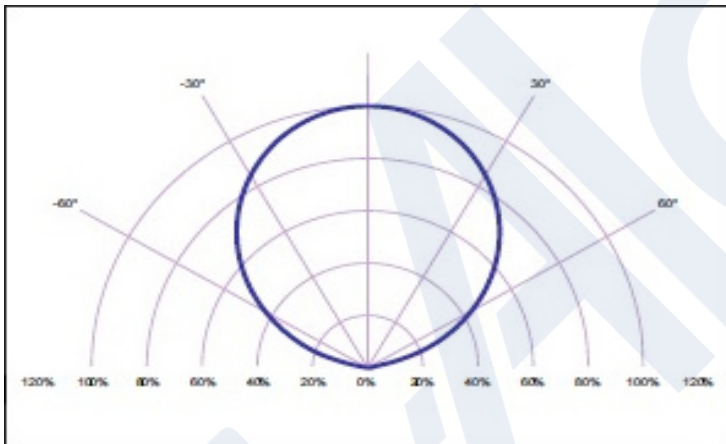
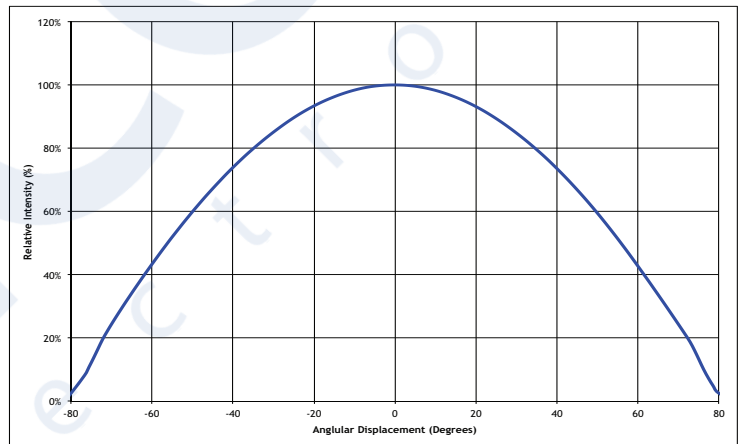
Relative Output Flux vs. Junction Temperature

Change in Voltage vs. Junction Temperature

Change in CIE_x/y vs. Junction Temp. (3000K, 90CRI)

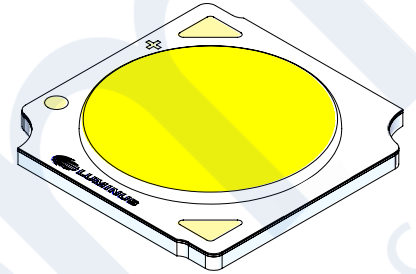
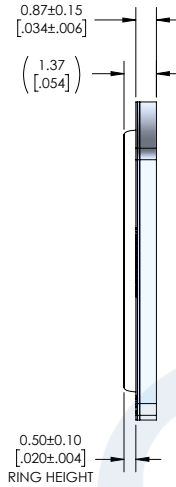
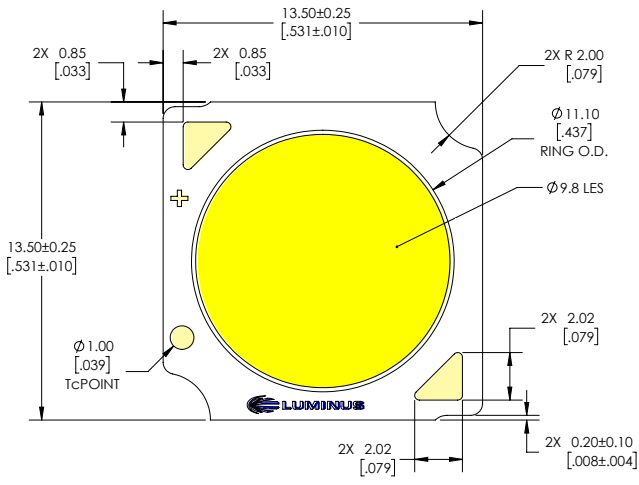
Change in CIE_x/y vs. Forward Current (3000K, 90CRI)

Optical & Electrical Characteristics - 18V
Relative Output Flux vs. Forward Current @ 85°C

Forward Current vs. Forward Voltage @ 85°C

Relative Output Flux vs. Junction Temperature

Change in Voltage vs. Junction Temperature

Change in CIE_x/y vs. Junction Temp. (3000K, 90CRI)

Change in CIE_x/y vs. Forward Current (3000K, 90CRI)

Typical Spectrum

Radiation Pattern
Typical Polar Radiation Pattern

Typical Angular Radiation Pattern

Mechanical Dimensions

Note: Unless otherwise specified, tolerance is $\pm 0.3\text{mm}$



Shipping Container



Package model -- for illumination

Note: 80 pcs per tray and 5 trays are stacked together to be sealed in an anti-static bag.



Note: The anti-static bag is boxed for easier storage, 400 pcs per box.

Label Information

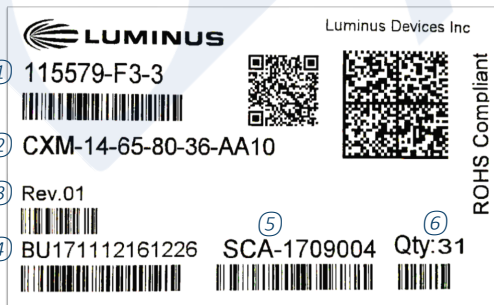

Label model -- for illumination only

Notes:

- ① Manufacture part number, flux bin and chromaticity bin
- ② Customer part number
- ③ Rev.01 indicates a fully released product
- ④ Box ID
- ⑤ Production ID
- ⑥ Total number of units in a box

Technology Overview

Luminus Chip-on-Board (COB) LED series offers a complete lighting class solution designed for high performance illumination applications. The selection covers a wide lumen range from less than 300lm to over 25,000lm, all major color temperatures and can deliver color rendering greater than 97 at 2700K and 3000K and R9 equal to 95. These breakthroughs allow illumination engineers and designers to develop lighting solutions with maximum efficacy, brightness and overall quality.

Reliability

Designed from the ground up, the Luminus COB LED is one of the most reliable light sources in the world today. Having passed a rigorous suite of environmental and mechanical stress tests, including mechanical shock, vibration, temperature cycling and humidity. Only then are the devices qualified for use in a wide range of lighting application including some of the most demanding commercial applications. Delivered with fully qualified LM80 test data and TM21 lifetime results that certify lumen maintenance at 50,000 hours or more, Luminus COB LEDs are ready for the toughest challenges.

UL Recognized Compliance

Luminus COB arrays are tested in accordance with ANSI/UL 8750 to ensure safe operation for their intended applications.

REACH & RoHS Compliance

All LED products manufactured by Luminus are REACH and RoHS compliant and free of hazardous materials, including lead and mercury

Test Specifications

Every Luminus LED is fully tested to ensure it meets the high quality standards customers have come to expect from Luminus' products.

Traceability

Each Luminus COB LED is marked with a 2D bar code that contains a unique serial number. With this serial number, Luminus has the ability to provide customers with actual test data measurements for a specific LED. In addition, the 2D bar code is linked to manufacturing date codes that enables traceability of production processes and materials.

Testing Temperature

Luminus COB products are measured at temperatures typical for the LED operating in the fixture. Each device is tested at 85°C junction temperature eliminating the need to scale data sheet specifications to real world situations.

Chromaticity Bin Range

Chromaticity binning delivers color consistency for every order. Standard products are delivered with a 3-step MacAdam ellipse. This ensures color performance matching in the application. For the most demanding application, Luminus is one of only a few companies that can provide a 2 SCDM bin distribution. These tightly controlled, small distribution bins provide customers predictable, repeatable colors.

Handling Notes

Luminus products are designed for robust performance in general lighting application. However, care must be taken when handling and assembling the LEDs into their fixtures. To avoid damaging Luminus COBs please follow these guidelines.

The following is an overview of the application notes detailing some of the practices to follow when working with these devices. More detailed information is available on the Luminus web site at www.luminus.com.

General Handling

Devices are made to be lifted or carried with tweezers on two adjacent corners opposite the contact pads. At no time should the devices be handled by or should anything come in contact with the light emitting surface (LES) area. This area includes the yellow colored circular area and the ring surrounding it. There are electrical connections under the LES which if damaged will cause the device to fail. In addition, the ring frame itself should not be used for moving, lifting or carrying the device. Also do not attach any optics or mechanical holders to the ring as it is not capable to handle the mechanical stress.

Storage Condition

Please follow the conditions below.

Before opened	Temperature 5~30 °C, relative humidity less than 60%. Note: before opened LED should be used within a year
After opened	Temperature 5~30°C, relative humidity less than 60%. Please apply soldering within one week. After opened LED should be kept in an aluminum moisture proof bag with a moisture absorbent material
Avoid corrosive gas	Avoid exposing to air with corrosive gas. If exposed, electrode surface would be damaged, which may affect soldering. Furthermore, if the device is stored in an environment which contain elements that could volatize resin material, then the volatized resin particles may stick to electrodes, which may result in connection failures.

Static Electricity

Luminus COBs are electronic devices which can be damaged by electrostatic discharge (ESD). Please use appropriate measures to assure the devices do not experience ESD during their handling and or storage. ESD protection guidelines should be used at all time when working with Luminus COBs.

Storage	Luminus products are delivered in ESD shielded bags and should be stored in these bags until used
Transporting	When transporting the devices from one assembly area to another, ESD shielded carts and carriers should be used
Assembly	Individuals handling Luminus COBs during assembly should be trained in ESD protection practices. Assemblers should maintain constant conductive contact with a path to ground by means of a wrist strap, ankle straps, mat or other ESD protection system

Chemical Compatibility

The resin material used to form the LES can get hydrocarbons from the surrounding environment. As a result, certain chemical compounds (H₂SO₄, H₂S, SO₂, NH₃, H₃PO₄ etc.) are not recommended for use with the Luminus products. Use of these compounds can cause damage to the light output of the device and may permanently damage the device. Please refer to the table below for a list of the compounds not recommended for use with the Luminus COB products.

Common Chemicals Know to Adversely Affect Luminus Devices		
Acetates	Ethers	Potassium hydroxide
Acetic acid	Cl, F or Br containing compounds	Siloxanes, fatty acids
Acrylates	Liquid hydrocarbons	Sodium Hydroxide
Aldehydes	Hydrochloric Acid	Sulfur compounds
Aldehydes	Ketones	Sulfuric Acid
Amines	Nitric Acid	Toluene
Benzene	Phosphoric acid	Xylenes
Dienes		

Thermal Interface Material (TIM)

Proper thermal management is critical for successful operation of any LED system. Excess operating temperature can reduce the light output of the device. And excessive heating can cause permanent damage to the device. Proper TIM material is a crucial component for effective heat transfer away from the LED during normal operation. Please refer to www.luminus.com for specific recommendations for TIM solutions. The compounds not recommended for use with the Luminus COB products.

Please refer to <https://www.luminus.com/resource/application-notes> for more application note information.