

V6/24

SFT-03X-CG

Projection Converted Green LED

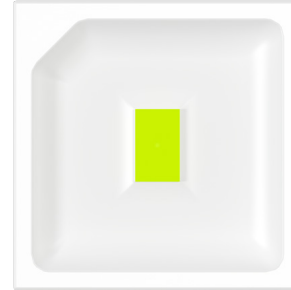

Features

- Converted Green (CG) LED with 0.35 mm² emitting area designed for high current density projection applications
- Emission area size and aspect ratio optimized for 0.16" / 0.2" micro display panels
- Compact 3030 SMT package
- Typical dominant wavelength: 555 nm
- Unencapsulated, windowless monolithic emitter allowing proximity optics, resulting in simpler and more efficient optical collection
- Matched SFM-03X-RAB Red/Blue LED for 2-channel projectors
- Large dynamic range: up to 2 A drive current



Applications

- Stand alone and embedded pico-projectors based on 0.16" and 0.2" class micro displays

Table of Contents

Ordering Information.	2
Binning Structure.	3
Absolute Maximum Ratings	4
Device Characteristics	5
Angular Distribution and Typical Spectrum.	7
Soldering Profile.	8
Mechanical Dimensions.	9
Tape and Reel Outline	10
Shipping Label.	11
Notes	12
Revision History.	13



Singel 3 | B-2550 Kontich | Belgium | Tel. +32 (0)3 458 30 33
info@alcom.be | www.alcom.be
Rivium 1e straat 52 | 2909 LE Capelle aan den IJssel | The Netherlands
Tel. +31 (0)10 288 25 00 | info@alcom.nl | www.alcom.nl



Ordering Information

Ordering Part Numbers¹

Color	Luminous Flux		Bin Kit Ordering Code	Ordering Part Number
	Min. Flux Bin	Min. Flux (lm)		
CG	2Z	85	MPZ	SFT-03X-CG-J30-MPZ
	2A	95	MPA	SFT-03X-CG-J30-MPA

Part Number Nomenclature

SFT	03X	CG	J30	<Bin kit>
Product Family	Chip Area	Color	Package Configuration	Bin Kit
SFT: Surface mount Flat Top windowless format	03: 0.35 mm ² X: Technology indicator	CG: Converted Green	J30: 3.0 mm x 3.0 mm Electrical and Thermal isolated SMT package	Refer to ordering part numbers in this document

Note:

1. Flux Bin listed is minimum bin shipped, higher bins may be included at Luminus' discretion.



Binning Structure

All SFT-03X LEDs are tested for luminous flux/dominant wavelength and placed into one of the following flux/wavelength bins. The binning structure is universally applied across each monochromatic color of the SFT-03X product line.

Flux Bins^{1,2}

Color	Flux Bin ³	Binning @ 0.25 A, T _c = 25°C	
		Min. Flux (lm)	Max. Flux (lm)
CG	2Z	85	95
	2A	95	105
	2B	105	115
	2C	115	125
	2D	125	135
	2E	135	145

Note:

1. Luminus maintains a +/- 6% tolerance on flux measurements.
2. Products are production tested then sorted and packed by bin.
3. Individual bins are not orderable. Please refer to the Product Ordering information page for a list of orderable bin kits.
4. T_c = Case temperature.



Absolute Maximum Ratings¹

	Symbol	Values	Unit
Forward Current (Single pulse 20 ms or Pulsed) ^{2,3,4}	$I_{f \min}$	0.1	A
	$I_{f \max}$	1.4	
Forward Current Pulsed ^{2,3,4} Frequency >240Hz, Duty <70%	$I_{fp \max}$	2.0	A
Forward Surge Current (Pulsed) ^{2,3,4} Frequency >240Hz, duty cycle <10% or t=1ms)	$I_{\text{surge max}}$	2.2	A
Storage Temperature	$T_{s \min}$	-40	°C
	$T_{s \max}$	100	
Junction Temperature	$T_{j \max}$	150	°C
ESD sensitivity ANSI/ESDA/JEDEC JS-001 (HBM, Class 2)	V_{ESD}	8000	V

Note:

1. All ratings are based on standard testing conditions at drive current 0.25 A, 20 ms single pulse at $T_c = 25^\circ\text{C}$.
2. In pulsed operation, rise time from 10% to 90% of forward current should be larger than 0.5 microseconds.
3. Product performance and lifetime data is specified at recommended forward drive current. Sustained operation at or near absolute minimum current may result in a reduction of device performance and device lifetime compared to recommended forward drive current.
4. Sustained operation above maximum current is not recommended and will result in a reduction of device lifetime.



Device Characteristics¹

Optical and Electrical Characteristics	Symbol	Values	Unit
Emitting Area	A_E	0.35	mm ²
Emitting Area Dimension		0.76 x 0.47	mm
Peak Luminous Flux ²	Φ_V	128	lm
Peak Radiometric Flux ²	Φ_E	0.28	W
Forward Voltage	$V_{f \min}$	2.5	V
	V_f	3.0	
	$V_{f \max}$	3.5	
Dominant Wavelength	$\lambda_{d \min}$	545	nm
	λ_d	555	
	$\lambda_{d \max}$	565	
FWHM- Spectral bandwidth at 50% of Φ_V	$\Delta\lambda_{1/2}$	100	nm
Chromaticity Coordinates ³	CIE x	0.33	
	CIE y	0.57	
Thermal Characteristics			
Real thermal resistance (junction-case)	$R_{th \text{ real (j-c)}}$	8.0	°C/W
Electrical thermal resistance ^{4,5} (junction-case)	$R_{th \text{ elec.(j-c)}}$	5.2	°C/W

Note:

- Product test condition: 0.25 A, 25°C case temperature.
- Typical flux at typical dominant wavelength.
- CIE 1931 chromaticity diagram coordinates, normalized to X+Y+Z=1.
- Thermal resistance values are based on modeled results correlated to measured $R_{th(j-c)}$ data using Forward Voltage sensitivity parametric method, compliant with JEDEC Standards JESD51-14.



Relative Luminous Flux

Forward current: $\phi_v/\phi_v(0.25\text{ A})$ Single pulse 20 ms, $T_c = 25^\circ\text{C}$

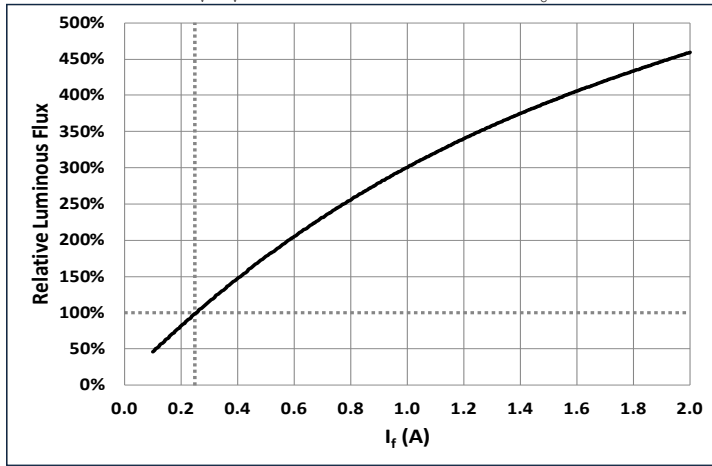

Temperature: $\phi_v/\phi_v(25^\circ\text{C})$ Single pulse 20 ms, $I_f = 0.25\text{ A}$

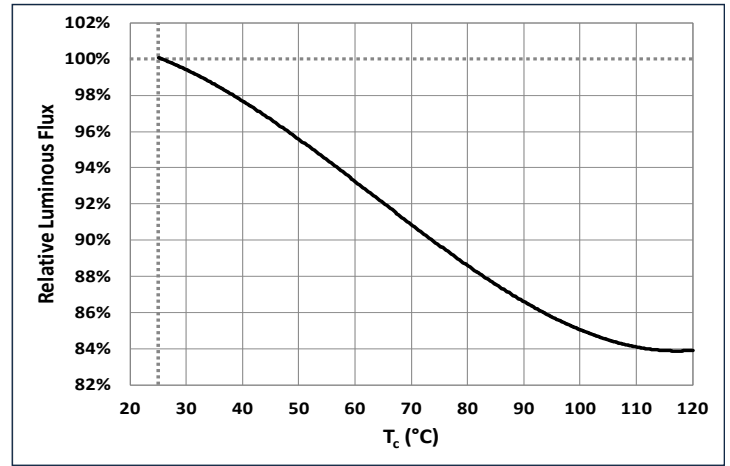

Forward Voltage Shift

Forward current: $V_f = V(I_f)$ Single pulse 20 ms, $T_c = 25^\circ\text{C}$

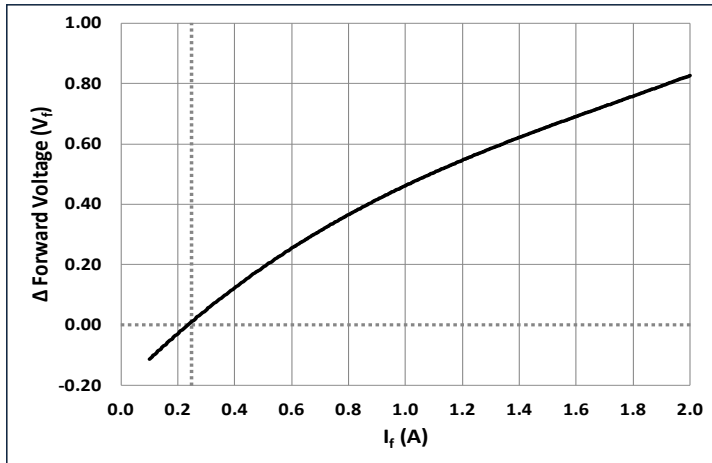

Temperature: $\Delta V_f = V(T_c) - V(25^\circ\text{C})$ Single pulse 20 ms, $I_f = 0.25\text{ A}$

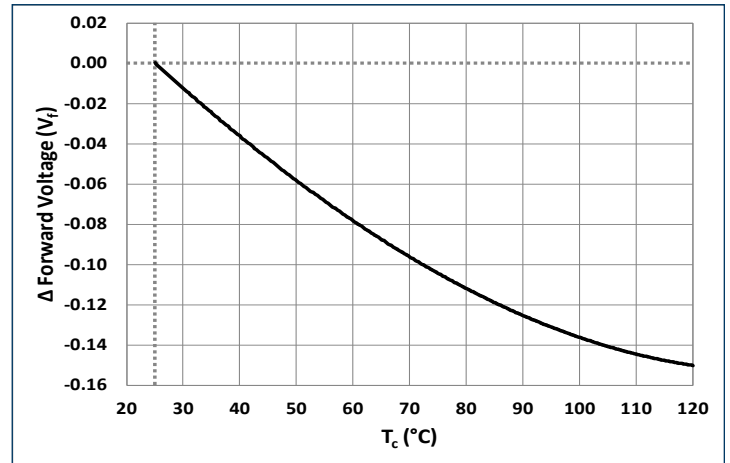

Dominant Wavelength Shift

Forward current: $\Delta\lambda_d = \lambda_d(I_f) - \lambda_d(0.25\text{ A})$ Single pulse 20 ms, $T_c = 25^\circ\text{C}$

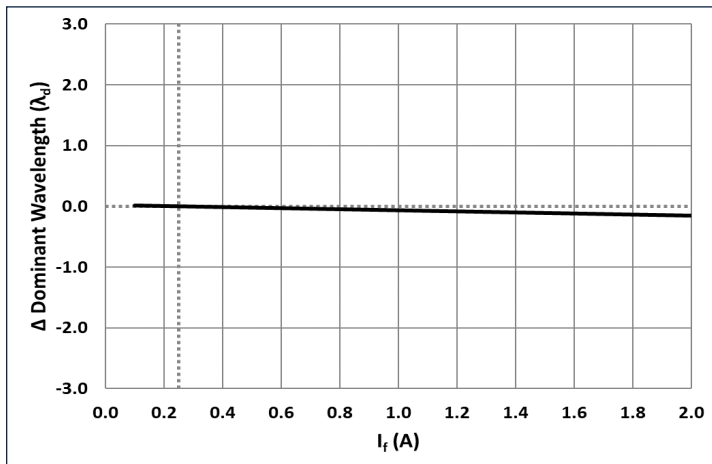

Temperature: $\Delta\lambda_d = \lambda_d(T_c) - \lambda_d(25^\circ\text{C})$ Single pulse 20 ms, $I_f = 0.25\text{ A}$

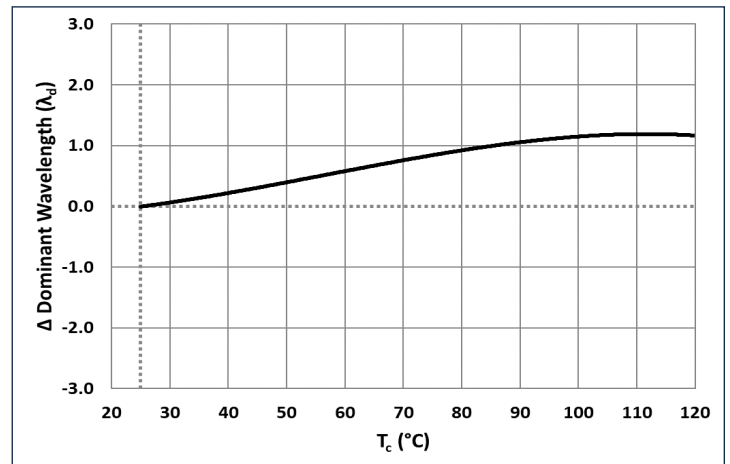



Angular Distribution and Typical Spectrum

Angular Intensity Distribution

$$I_{ref} = f(\Phi); T_c = 25^\circ\text{C}$$

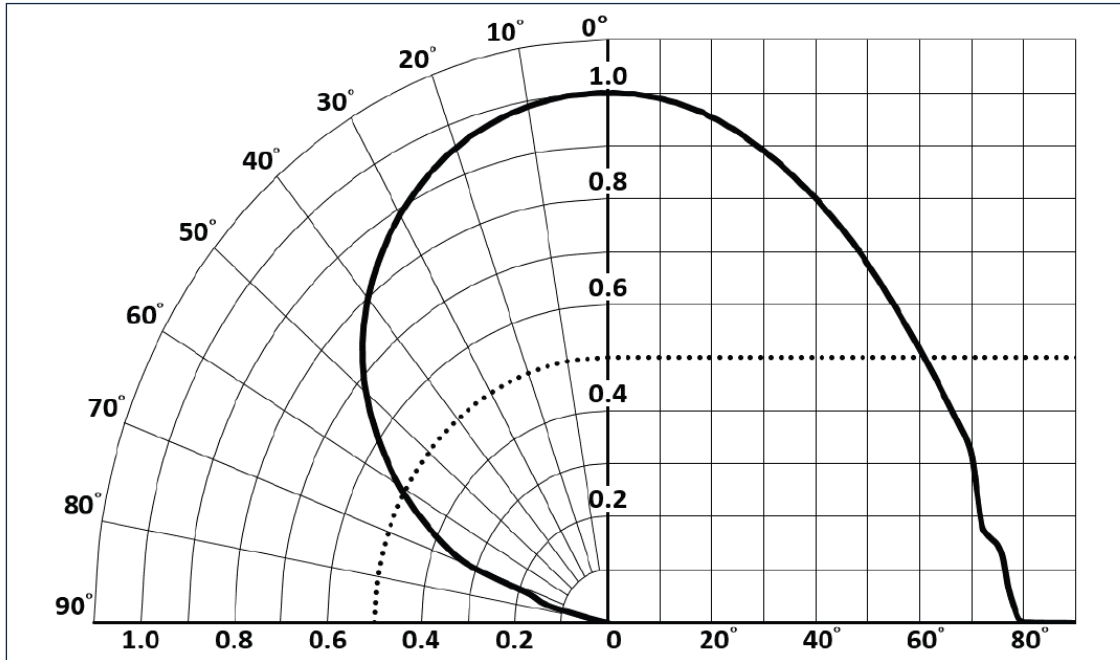

Typical Spectrum

$$\Phi_{ref} = f(\lambda); I_f = 0.25 \text{ A}; T_c = 25^\circ\text{C}$$

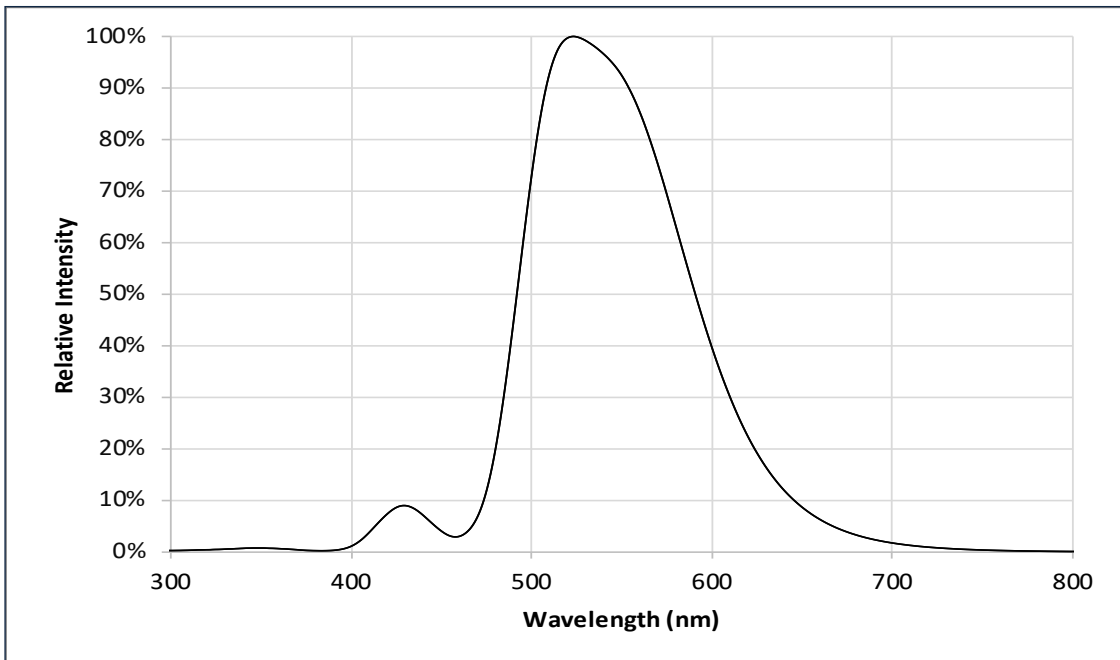



Soldering Profile

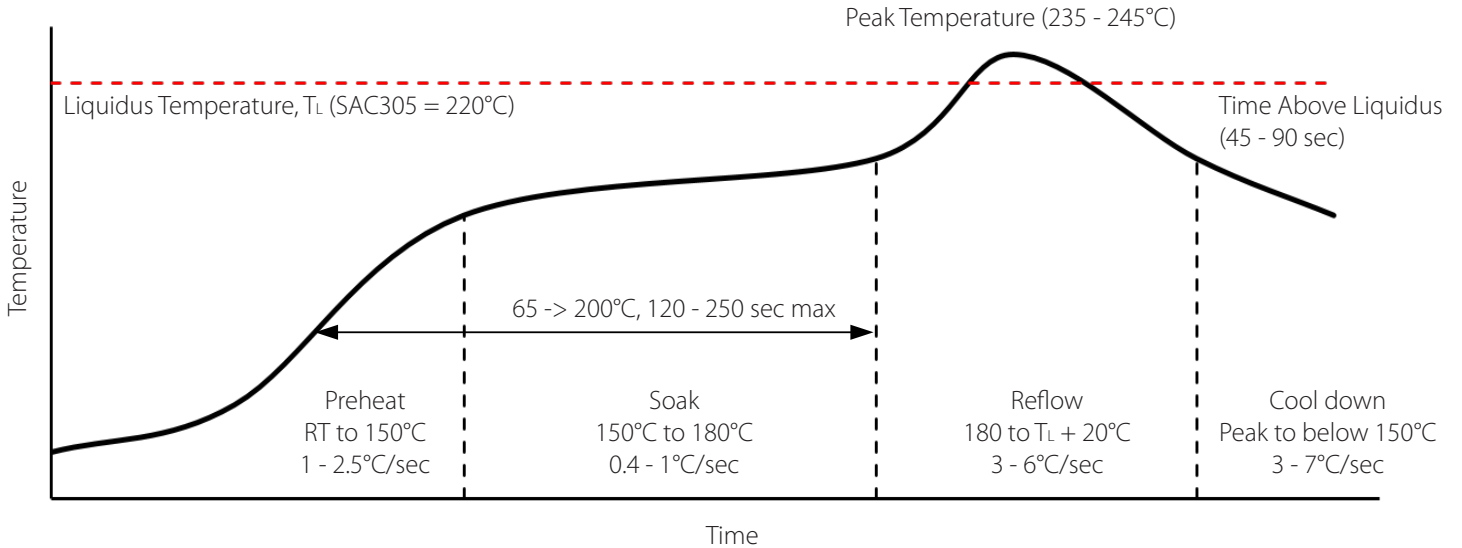

SMT Rework Guideline	Manual Hotplate Reflow	Hot Air Gun Reflow
Heating Time	< 60 sec	
Hotplate Temperature	< 245°C	< 150°C

Note:

- Product complies to Moisture Sensitivity Level 3 (MSL 3).
- The numbers in the table are specific to SAC305. Luminus recommends using an SAC305 solder paste with a no-clean flux for RoHS compliant products.
- During the pick and place process, ensure the pick-up tool does not touch any die components.
- Use of a multi-zone IR reflow oven with a nitrogen blanket is recommended.
- Time-temperature profile of the reflow process showing the four functional profile zones are defined in IPC-7801. Temperature is referenced to the center of the PCB.
- Luminus recommends to use the solder paste data sheet information as a starting point in time-temperature process development.
- These are general guidelines. Consult the solder paste manufacturer's datasheet for guidelines specific to the alloy and flux combination used in your application. For more information, please refer to:
<https://luminusdevices.zendesk.com/hc/en-us/articles/360060306692-How-do-I-Reflow-Solder-Luminus-SMD-Components->
- For any technical questions about soldering process, please contact Luminus at techsupport@luminus.com.



Mechanical Dimensions

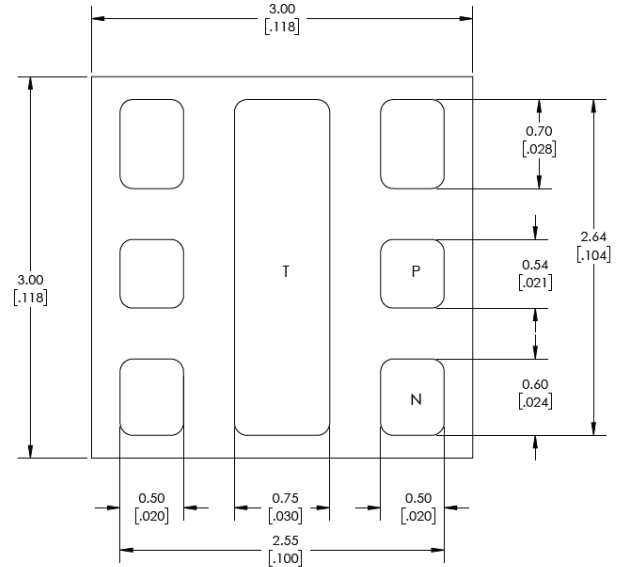
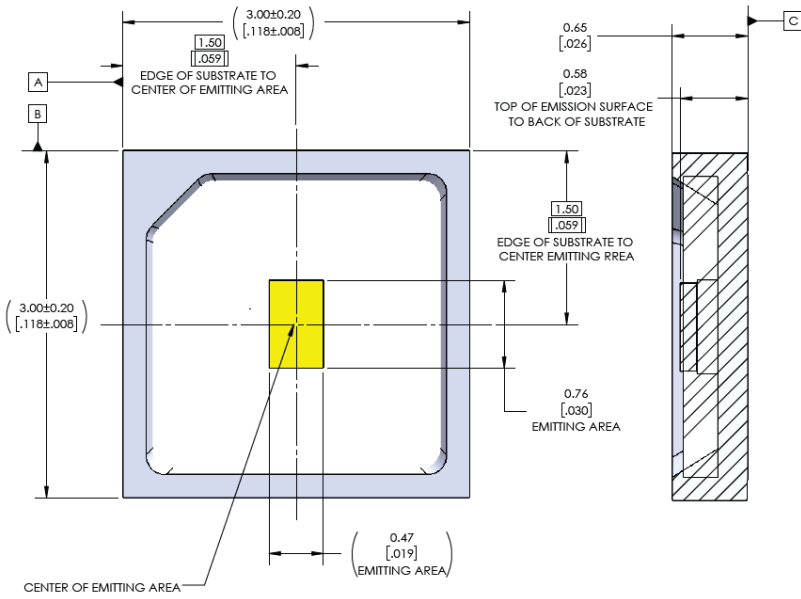

PAD ASSIGNMENTS	
P	ANODE
N	CATHODE
T	THERMAL PAD

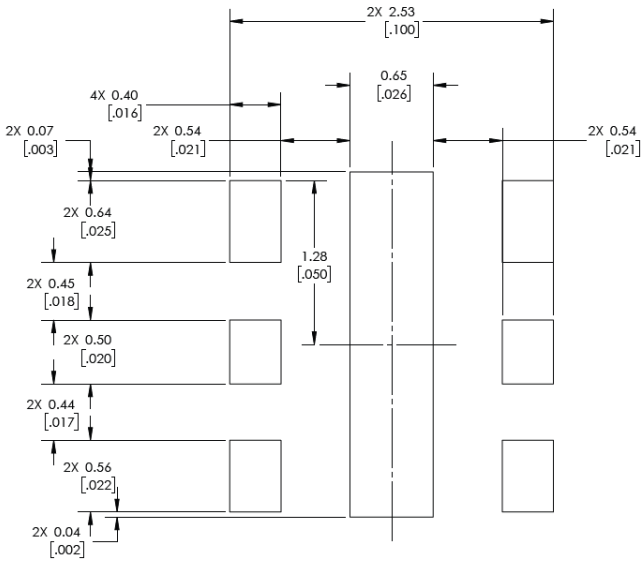

RECOMMENDED STENCIL PATTERN

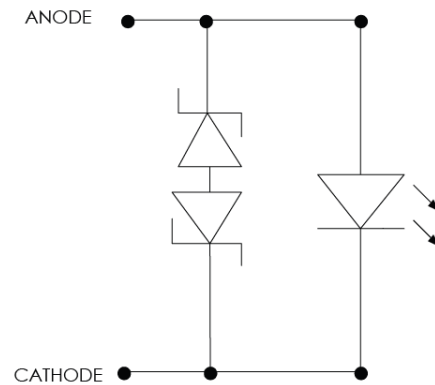

ELECTRICAL CIRCUIT



Tape and Reel Outline

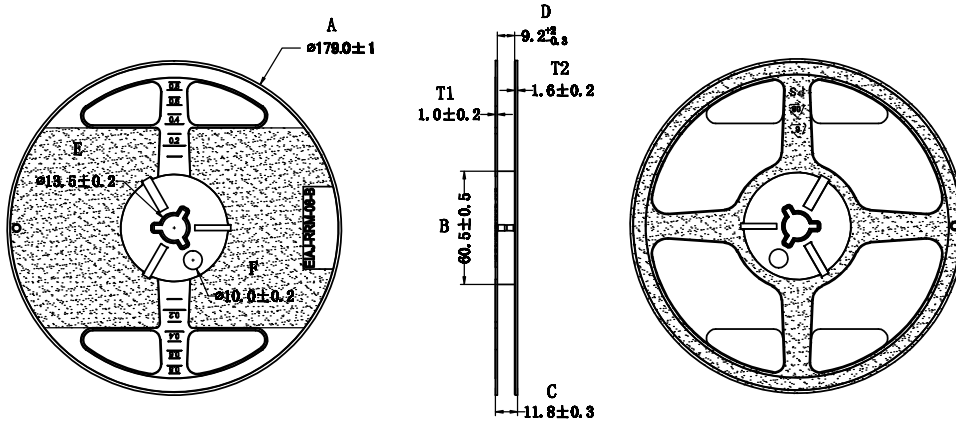

Parameter	Dimension (mm)
A	179.0+/-1.0
B	60.5+/-0.5
C	11.8+/-0.3
D	9.2+2.0 9.2-0.3
E	13.5+/-0.2
F	10.0+/-0.2
T1	1.0+/-0.2
T2	1.6+/-0.2

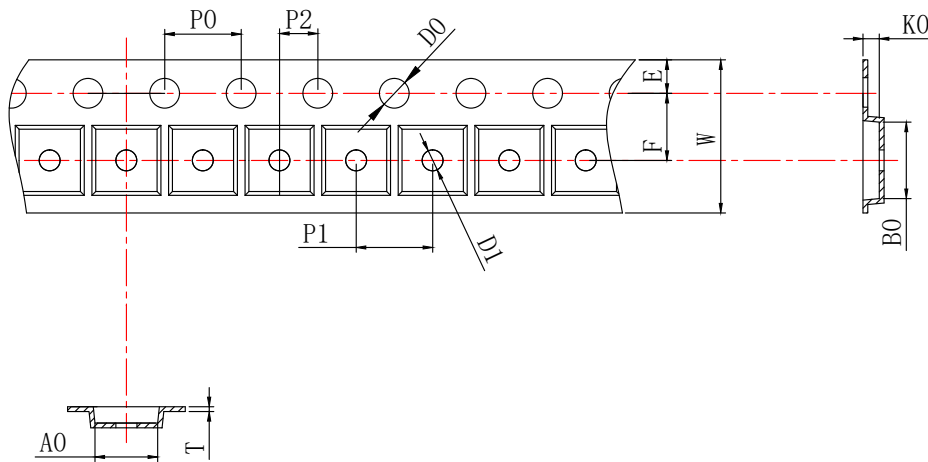

Parameter	Dimension (mm)
A0	3.20+/-0.10
B0	3.40+/-0.10
K0	0.85+/-0.10
P0	4.00+/-0.10
P1	4.00+/-0.10
P2	2.00+/-0.10
T	0.20+/-0.05
E	1.75+/-0.10
F	3.50+/-0.10
D0	1.55+/-0.05
D1	1.10+/-0.05
W	8.00+/-0.10

Note: Minimum order quantity: 500 pieces.



Shipping Label

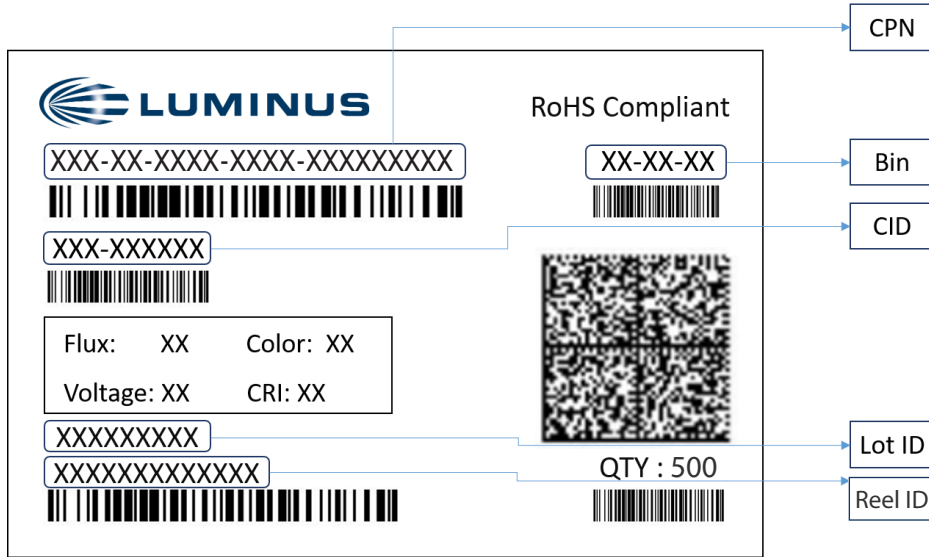

Label Fields:

- CPN: Luminus ordering part number
- CID: Customer's part number
- QTY: Quantity of devices in pack
- Flux: Bin as defined on page 3
- Voltage: NA
- Color: NA
- CRI: NA
- Lot ID: For Luminus internal use
- Reel ID: For Luminus internal use

Packing Configuration:

- Maximum of 500 devices per reel
- Partial reel may be shipped
- Each pack is enclosed in anti-static bag
- Shipping label is placed on top of each pack



Notes

Static Electricity

This product is sensitive to static electricity, and care should be taken when handling them. Static electricity or surge voltage will damage the LEDs. It is recommended to wear an anti-electrostatic wristband or anti-electrostatic gloves when handling the LEDs. All devices, equipment and machinery must be properly grounded. It is recommended that measures be taken to isolate LED processing equipment from potential sources of voltage surges.

Reference: APN-002815 Electrical Stress Damage to LEDs and How to Prevent It

Eye Safety

According to the test specification risk group IEC 62471-Non-GLS under 0.25 A, this product complies to Risk group 2 (RG2) Moderate risk.

Do not stare at operating lamp, may be harmful to the eyes.

For more information, please refer to: <https://luminusdevices.zendesk.com/hc/en-us/articles/10532958752397>



Revision History

Rev	Date	Description of Change
01	03/22/2024	Initial release



Singel 3 | B-2550 Kontich | Belgium | Tel. +32 (0)3 458 30 33
info@alcom.be | www.alcom.be
Rivium 1e straat 52 | 2909 LE Capelle aan den IJssel | The Netherlands
Tel. +31 (0)10 288 25 00 | info@alcom.nl | www.alcom.nl