



OPTICAL ENERGY DESIGN & DEVICES

INDOOR



LinkedIn

Website

WeChat

Chengdu HercuLux Photoelectric Technology Co., Ltd.

Add: Room 501-510, Comprehensive Service Building,
Innovation Industrial Park, Nanshan Cloud Valley, Nanshan District,
Shenzhen City, Guangdong P.R China, Zip code: 518055
Tel: +86 755 2640 6841 Fax: +86 755 2907 5140
Email: sales@herculux.com Website: <http://www.herculux.com/en>

HercuLux Optics is a high-tech enterprise dedicated to providing system solutions for LED lighting, UV curing, laser projection, AOI machine vision inspection and other applications. National Specialized, Specialized and New "Small Giant" High-tech Enterprises.



HercuLux Optics is a high-tech Specialized and Sophisticated SMEs dedicated to providing system solutions for applications such as LED lighting, UV curing, laser projection, and AOI machine vision inspection.

We have a R&D team with the background in the Institute of Optics and Electronics, Chinese Academy of Sciences, consisting of experts who have been working for decades in the fields of optics, precision optical molds and precision optical injection molding, fine chemicals and electronic control, as well as a highly efficient and passionate marketing team, which ensures fast product innovation, stable and reliable quality of the products, and fast and considerate service.

Since the start of our company, in order to address the secondary light distribution problems in many LED applications, the company has introduced products such as calculus anti-glare lens, nearly 100% efficiency of the adaptive colloidal street lamp lens, very small angle (less than 3 deg) outdoor spotlight lens, ultra-thin (thickness of less than 8mm) triple total reflection lens, the angle and spot shape of the optical lens module can be changed, efficiency of more than 90% of the zoom series, CCT changing COB can be matched full stroke high efficiency (greater than 80%) high center light intensity of the zoom optical module, MOS film, high temperature-resistant silicone materials and lens, anti-glare firefly series.

For the AOI machine vision inspection field, the introduction of photolithography plate plane shadowless light source, to fill the gaps in the domestic market; for the

printing curing field, the world's first introduction of full UV (A \ B \ C) LED direct contact with the large-scale printing press curing modules and systems, not only for the printing industry to save energy, but also for the printing industry to save energy, and the printing industry to save energy. system, not only for the printing industry energy saving and environmental protection to provide a perfect solution and further enhance the printing overprint accuracy and significantly reduce the odor of printed materials due to ozone.

National High tech Enterprise - Established in 2013; Obtained the national high-tech enterprise qualification in 2014; Obtaining the national high-tech enterprise qualification in 2014 was the first enterprise in Sichuan to obtain the national high-tech enterprise qualification the following year after its establishment.

Computer Software Copyright - To ensure the perfect presentation of design theoretical values on actual products, HercuLux has independently developed specialized optical conversion software and injection molding analysis precision compensation software.

Patents - The company has applied for more than 330 patents and has obtained 222 patent authorizations, including 11 authorized invention patents, 106 utility model patents, 105 appearance patents, and is currently applying for 3 PCT patents.

R & D capabilities - The R&D team of the company is composed of a team of experts with a background in the Institute of Optoelectronics, Chinese Academy of Sciences. There are 32 R&D personnel, accounting for 26.45% of the total number of employees. Among them, there are 8 full-time optical design engineers, including one senior engineer, three master's, and four undergraduate students.



KIRIN OPTICAL PLATFORM

008 DARK

048 V SERIES

014 GEMINI

054 ZOOM MODULE

020 MOONY

058 MAVIC & MAVIC PRO

074 FIREFLY-KIRIN

082 LIGHT FILTER

026 GLARELESS

062 KA PRO

078 COB HOLDER

086 LIGHT HOOD

032 PEAK

068 MOONY PRO

080 LENS HOLDER

036 FILMY

070 PEAK PRO

042 RAINBOW

072 SILICONE LENS

INDOOR

092 PHOTON

112 INFINITY

128 WARTERFALL

098 KA

118 FOCUS

130 TRANSFORMERS

144 LIGHTNING

104 CHAMELEON

122 POLAROID

134 DIAMOND

148 COMET

108 BLACK HOLE

126 SUNFLOWER

140 NEBULA

150 CUSTOMIZED SOLUTIONS

Products Code Rule





Filter Holder



Light Filter

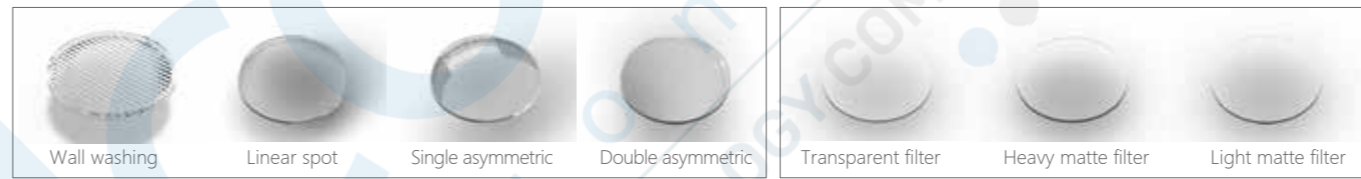

Pin-pin replacement; COB holder: Same outer diameter, Screw position is consistent, Rotating interface is consistent.

Lens



Lens Holder



COB Holder

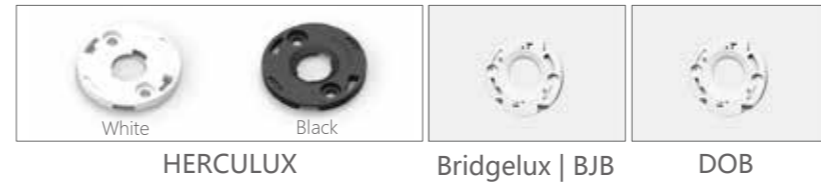

DARK SERIES

A lens for the high-efficiency spot of the hotel's deep anti-glare wall washing spotlight

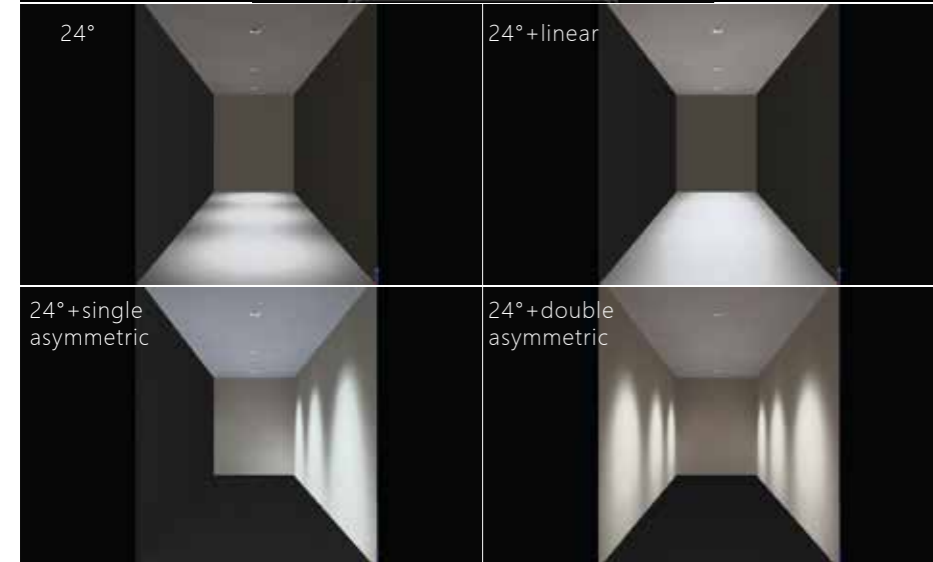
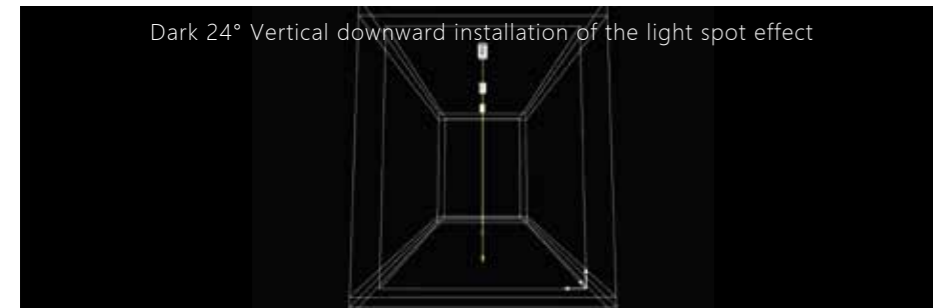

The unique optical design of the narrow beam angle makes the spot more concentrated while less glare.

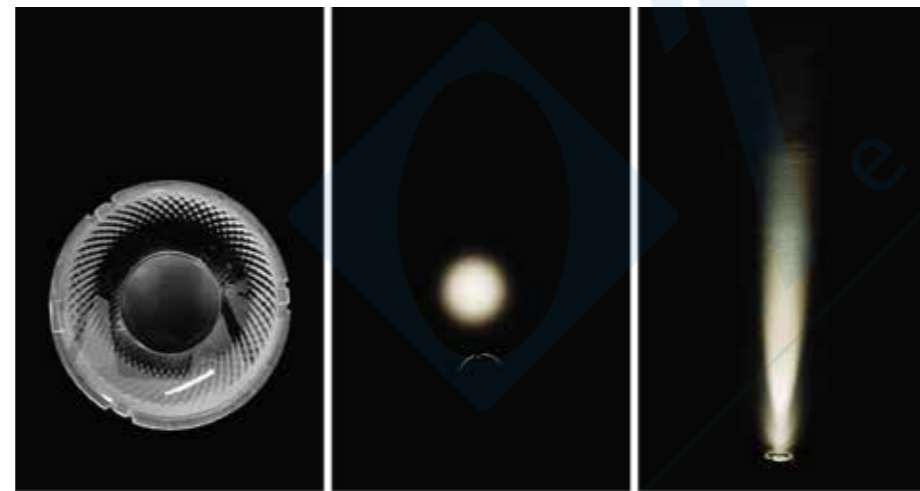

Hotel wall washer spotlight, deep anti-glare structure

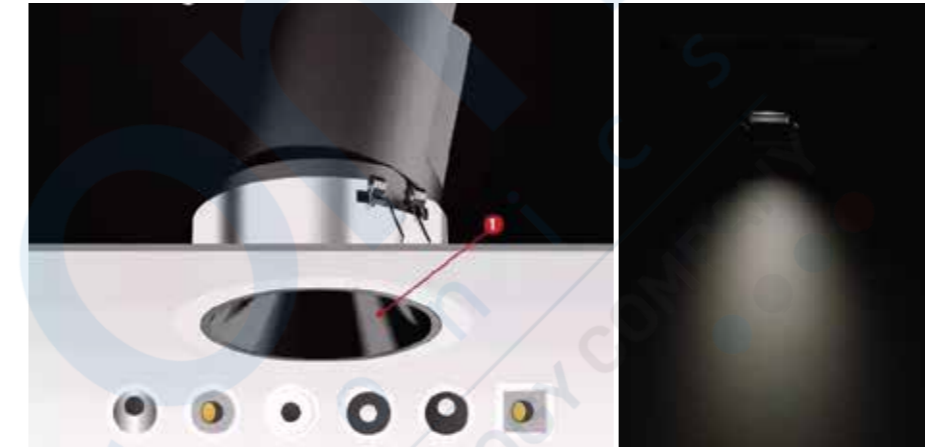

Cross-lighting for the ultimate in anti-glare

The cross-lighting design principle makes the lamps and lanterns with light holes smaller than the optical diameter, together with the small holes of the hood, hiding deeper and better control of glare, and the optical efficiency has little impact, but also to ensure that the spot effect.



Assembly size of small hole hood

Lens dia(mm)	Hood height(mm)	Hood small hole dia(mm)	Distance from hole to lens(mm)
25	13	17	6
30	16	19	8
35	16	23	9
45	21	29	12
50	24	35	14
55	25	38	19
62	30	46	20
68	32	48	22
75	35	52	25
83	40	65	29



DARK SERIES



DARK 20@11 (3030)

φ: 19mm H: 11mm
Material: PMMA
FWHM: 15°/24°/36°/50°
Efficiency: 91%



DARK 20@12 (3535)

φ: 20mm H: 12mm
Material: PMMA
FWHM: 15°/24°/36°/50°
Efficiency: 91%



DARK 25@13 (D4)

φ: 25mm H: 13mm
Material: PMMA
FWHM: 10°/15°/24°/36°/50°
Efficiency: 91%



DARK 30@16

φ: 30mm H: 16mm
Material: PMMA
FWHM: 10°/15°/24°/36°/50°
Efficiency: 91%



DARK 35@16

φ: 35mm H: 16mm
Material: PMMA
FWHM: 10°/15°/24°/36°/50°
Efficiency: 91%



DARK 45@21

φ: 45mm H: 21mm
Material: PMMA
FWHM: 10°/15°/24°/36°/50°
Efficiency: 91%



DARK 50@24

φ: 50mm H: 24mm
Material: PMMA
FWHM: 10°/15°/24°/36°/50°
Efficiency: 91%



DARK 55@25

φ: 55mm H: 25mm
Material: PMMA
FWHM: 10°/15°/24°/36°/50°
Efficiency: 91%

DARK SERIES



DARK 62@30

φ: 62mm H: 30mm
Material: PMMA
FWHM: 10°/15°/24°/36°/50°
Efficiency: 93%



DARK 68@32

φ: 68mm H: 32mm
Material: PMMA
FWHM: 10°/15°/24°/36°/50°
Efficiency: 91%



DARK 75@35

φ: 75mm H: 35mm
Material: PMMA
FWHM: 10°/15°/24°/36°/50°/70°
Efficiency: 91%



DARK 83@40

φ: 83mm H: 40mm
Material: PMMA
FWHM: 10°/15°/24°/36°/50°/70°
Efficiency: 91%



GEMINI SERIES

A reflector combines with a lens

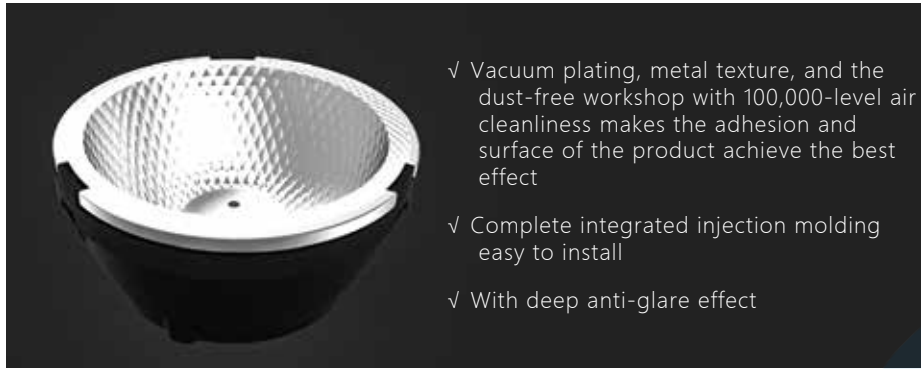

Comes with 30° anti-glare angle

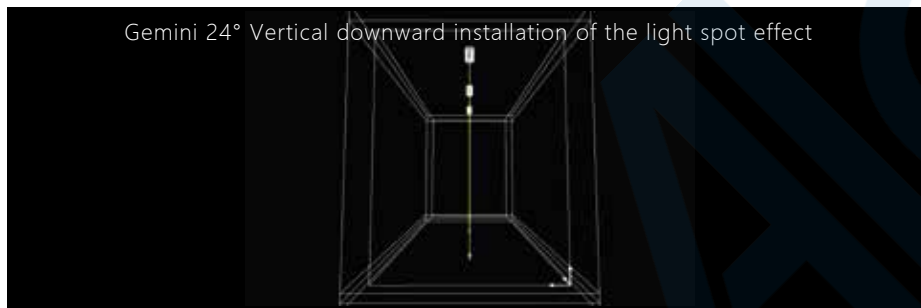
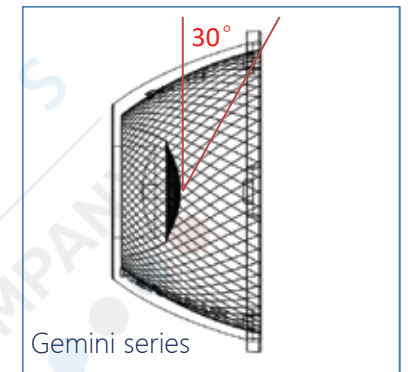
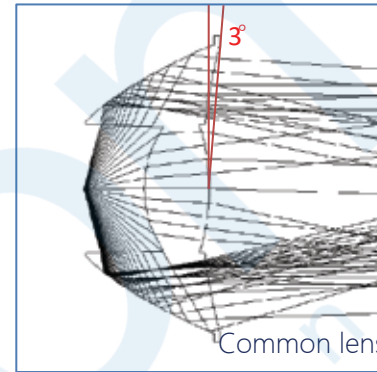

Through the cross light distribution and the control of the proportion of the intermediate light, the wall washing light spot is also relatively clean.

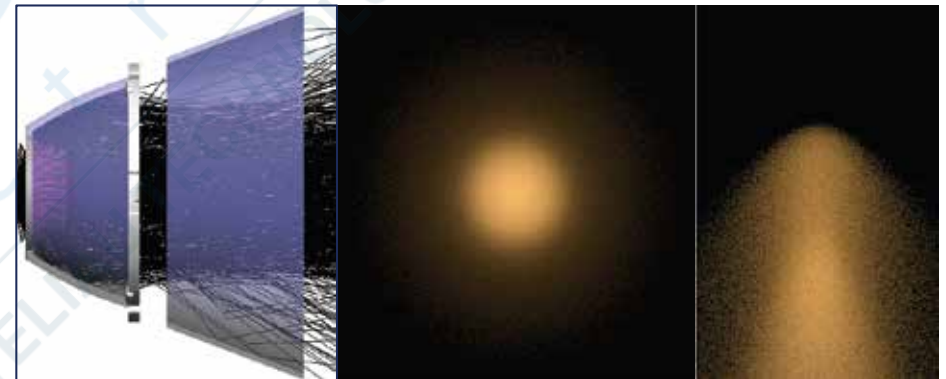
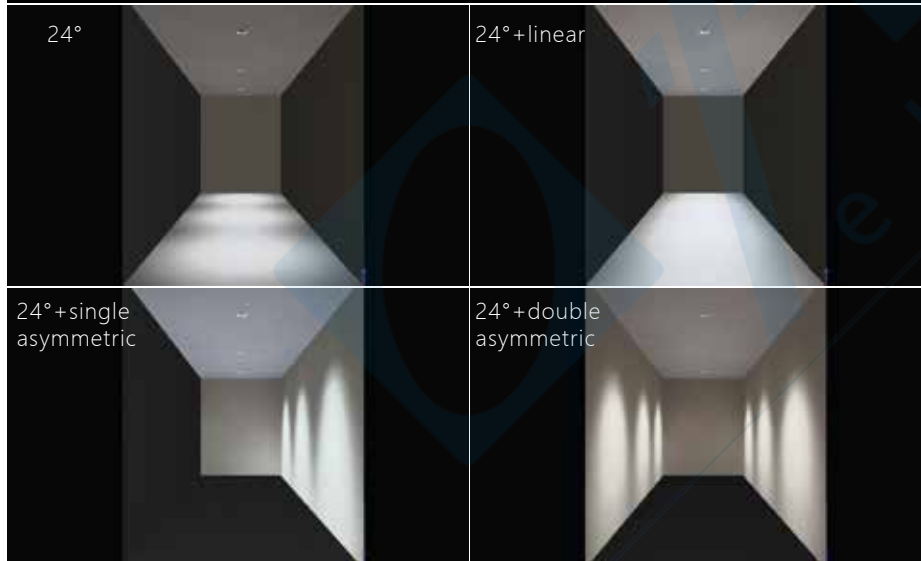

Cross light control, reasonable light control

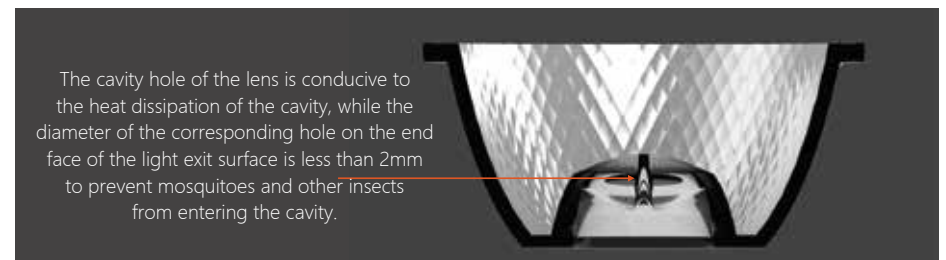

GEMINI SERIES

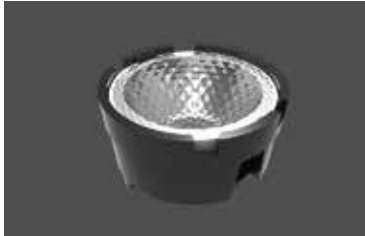

GEMINI 25@13

φ: 25mm H: 13mm
Material: Vacuum Aluminum Plating PC
FWHM: 18°/24°/36°/50°
Efficiency: 80%



GEMINI 30@16

φ: 30mm H: 16mm
Material: Vacuum Aluminum Plating PC
FWHM: 15°/24°/36°/50°
Efficiency: 80%



GEMINI 35@16

φ: 35mm H: 16mm
Material: Vacuum Aluminum Plating PC
FWHM: 15°/24°/36°/50°
Efficiency: 80%

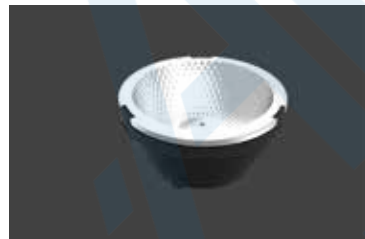

GEMINI 45@21

φ: 45mm H: 21mm
Material: Vacuum Aluminum Plating PC
FWHM: 15°/24°/36°/50°
Efficiency: 80%



GEMINI 50@24

φ: 50mm H: 24mm
Material: Vacuum Aluminum Plating PC
FWHM: 15°/24°/36°/50°
Efficiency: 80%



GEMINI 55@25

φ: 55mm H: 25mm
Material: Vacuum Aluminum Plating PC
FWHM: 15°/24°/36°/50°
Efficiency: 80%



GEMINI 62@30

φ: 62mm H: 30mm
Material: Vacuum Aluminum Plating PC
FWHM: 15°/24°/36°/50°
Efficiency: 80%

GEMINI SERIES



GEMINI 68@32

φ: 68mm H: 32mm
Material: Vacuum Aluminum Plating PC
FWHM: 15°/24°/36°/50°
Efficiency: 80%



GEMINI 75@35

φ: 75mm H: 35mm
Material: Vacuum Aluminum Plating PC
FWHM: 15°/24°/36°/50°
Efficiency: 80%



GEMINI 83@40

φ: 83mm H: 40mm
Material: Vacuum Aluminum Plating PC
FWHM: 15°/24°/36°/50°
Efficiency: 80%

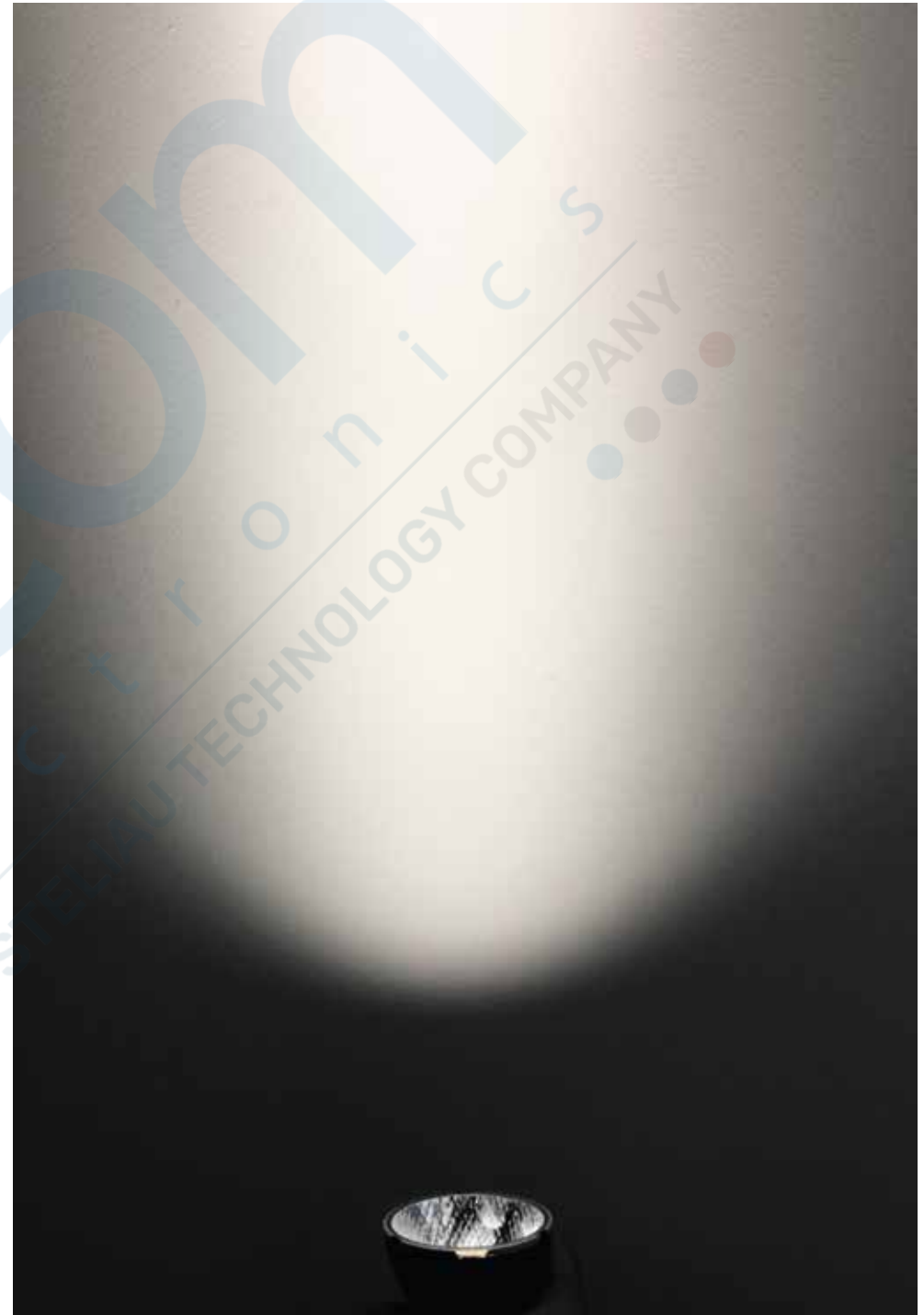

MOONY SERIES

A clean wall washer lens can match with CCT changing COB



Moony series can achieve similar wall wash effect of reflector, with clean edge cutoff, even transition and no delamination, and can also be matched with CCT changing COB for smart lighting applications.



By strengthening the light on the receiving surface of the light emitting surface, this part of the light is forcibly cut off by the anti glare cover when passing through it, resulting in a clear cut-off line when washing the wall.

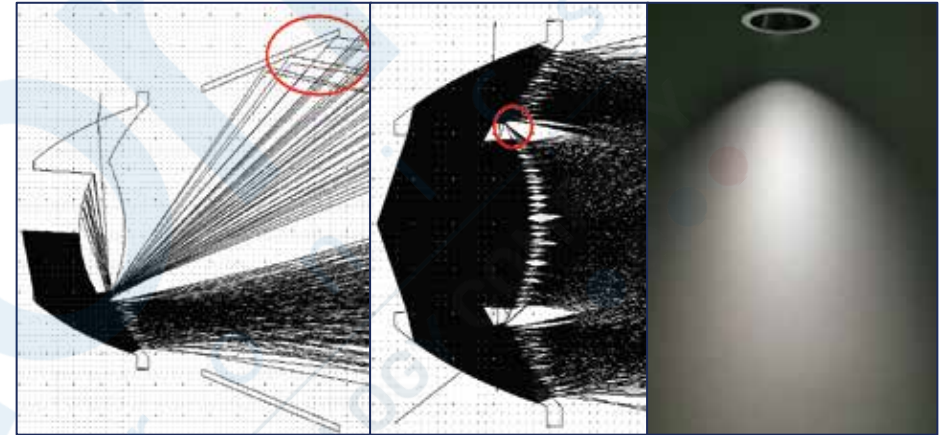

CCT changing COB can be matched

The light is split and concentrated through the microstructure of the lens, so that the color mixing of the light spot is more uniform.



MOONY SERIES

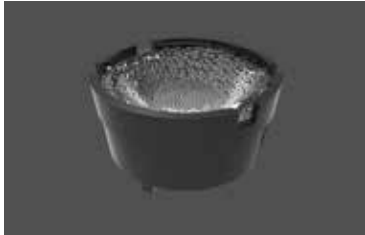

MOONY 25@13

φ: 25mm H: 13mm

Material: PC/PMMA

FWHM: 18°/24°/36°/50°

Efficiency: 88%



MOONY 35@16

φ: 35mm H: 16mm

Material: PC

FWHM: 15°/24°/36°/50°

Efficiency: 88%



MOONY 30@15

φ: 30mm H: 15mm

Material: PC

FWHM: 15°/24°/36°/50°

Efficiency: 88%

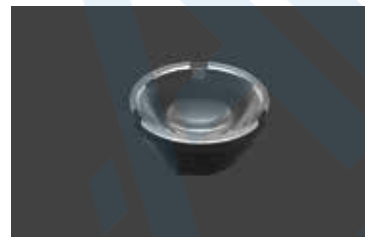

MOONY 45@21

φ: 45mm H: 21mm

Material: PC

FWHM: 15°/24°/36°/50°

Efficiency: 88%



MOONY 50@24

φ: 50mm H: 24mm

Material: PC

FWHM: 15°/24°/36°/50°

Efficiency: 88%



MOONY 55@25

φ: 55mm H: 25mm

Material: PC

FWHM: 15°/24°/36°/50°

Efficiency: 88%



MOONY 62@30

φ: 62mm H: 30mm

Material: PC

FWHM: 15°/24°/36°/50°

Efficiency: 88%

MOONY SERIES



MOONY 68@32

φ: 68mm H: 32mm
Material: PC
FWHM: 15°/24°/36°/50°
Efficiency: 88%



MOONY 75@35

φ: 75mm H: 35mm
Material: PC
FWHM: 15°/24°/36°/50°
Efficiency: 88%



MOONY 83@40

φ: 83mm H: 40mm
Material: PC
FWHM: 15°/24°/36°/50°
Efficiency: 88%

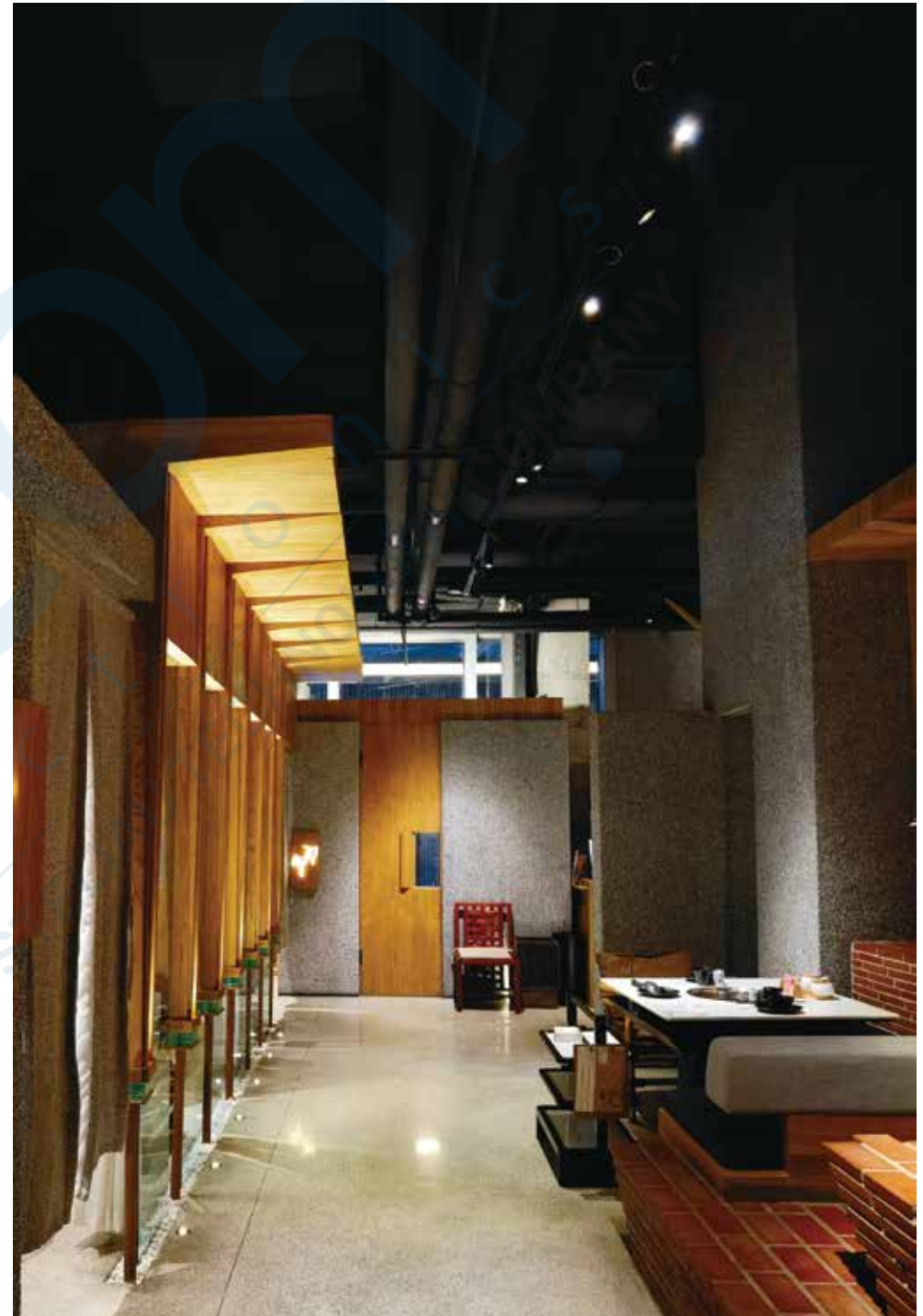

GLARELESS SERIES

A lens with anti-glare effect

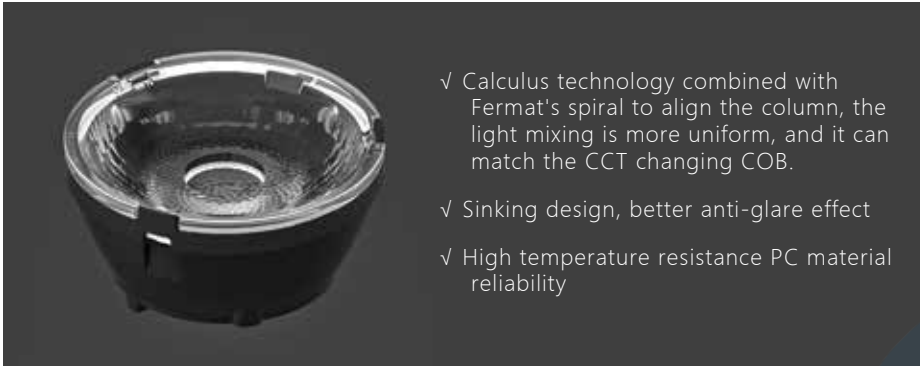

Come with 20° anti-glare angle

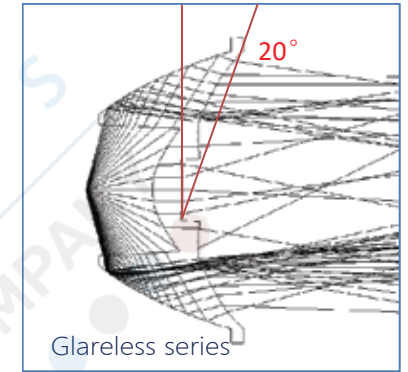
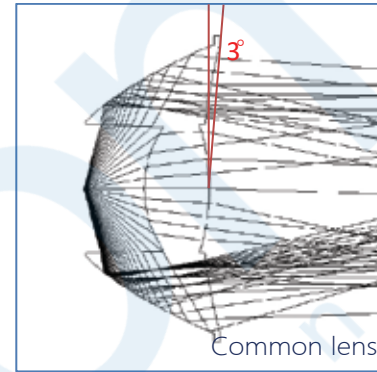

Smooth the surface, more conducive to anti-glare

The light-emitting surface is smoothly treated, and there is no matte, sun-stripe and other structures, so that the light-emitting surface is no stray light and no glare.



CCT changing COB can be matched

The reflective surface adopts calculus technology, so that the lens can match with CCT changing COB, and the spot is more uniform..

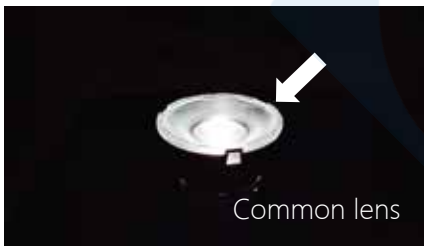

Spot effect

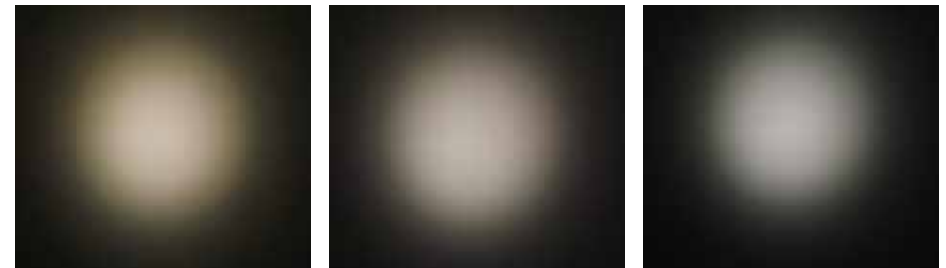

GLARELESS SERIES



GLARELESS 25@13

φ: 25mm H: 13mm
Material: PC
FWHM: 15°/24°/36°/60°
Efficiency: 88%



GLARELESS 35@16

φ: 35mm H: 16mm
Material: PC
FWHM: 15°/24°/36°/60°
Efficiency: 88%



GLARELESS 30@16

φ: 30mm H: 16mm
Material: PC
FWHM: 15°/24°/36°/60°
Efficiency: 88%



GLARELESS 45@21

φ: 45mm H: 21mm
Material: PC
FWHM: 15°/24°/36°/60°
Efficiency: 88%



GLARELESS 50@24

φ: 50mm H: 24mm
Material: PC
FWHM: 15°/24°/36°/60°
Efficiency: 88%



GLARELESS 55@25

φ: 55mm H: 25mm
Material: PC
FWHM: 15°/24°/36°/60°
Efficiency: 88%



GLARELESS 62@30

φ: 62mm H: 30mm
Material: PC
FWHM: 15°/24°/36°/60°
Efficiency: 88%

GLARELESS SERIES



GLARELESS 68@32

φ: 72mm H: 22mm
Material: PC
FWHM: 15°/24°/36°/60°
Efficiency: 88%



GLARELESS 75@35

φ: 75mm H: 35mm
Material: PC
FWHM: 15°/24°/36°/60°
Efficiency: 88%



GLARELESS 83@40

φ: 83mm H: 40mm
Material: PC
FWHM: 15°/24°/36°/60°
Efficiency: 88%



PEAK SERIES

A clean wall-washing and extremely deep anti-glare lens



Surface treatment, directional light control

Special treatment of the light in certain positions of the Peak series lens so that with the glare shield, some of the light just passes over the edge of the large opening of the glare shield, making it a more obvious cut-off line between light and dark when washing the wall.

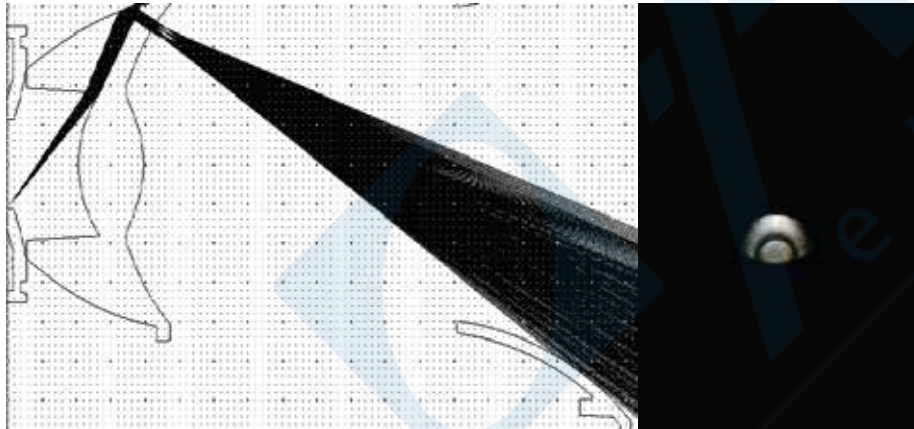

Matching with light hood to achieve ultimate anti-glare

Adding microstructure on the surface of the lens makes the light cross-mix more evenly on the surface of the lens, and with the anti-glare cover developed by our company, the light spot of the wall washing is more even.

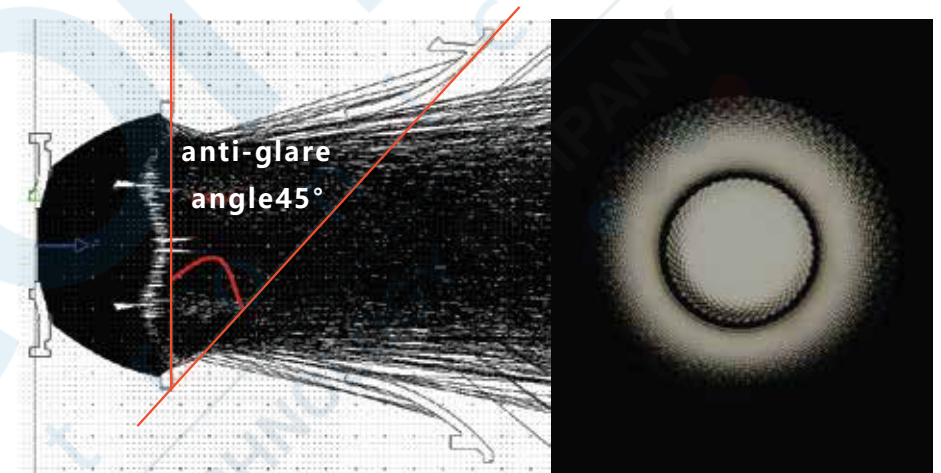

More uniform light spot

The reflective surface treatment allows some of the light to cross-mix in multiple places within the lens and then mix again at the exit surface, resulting in a more uniform overall light spot.

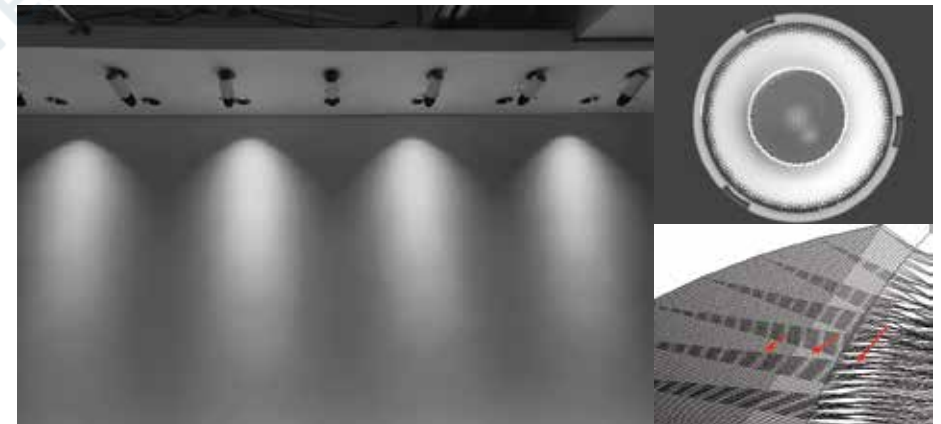

PEAK SERIES



PEAK/ PEAK V 25@13

φ: 25mm H: 13mm

Material: PMMA

FWHM: 15°/24°/36°/50°

(PEAK V no 50 °)

Efficiency: 90%



PEAK/ PEAK V 35@16

φ: 35mm H: 16mm

Material: PMMA

FWHM: 15°/24°/36°/50°

(PEAK V no 50 °)

Efficiency: 90%



PEAK 30@15

φ: 30mm H: 15mm

Material: PMMA

FWHM: 15°/24°/36°/50°

Efficiency: 90%



PEAK/ PEAK V 40@19

φ: 40mm H: 19mm

Material: PMMA

FWHM: 15°(developing)/24°/36°/50°

(PEAK V no 50 °)

Efficiency: 90%



PEAK/ PEAK V 45@21

φ: 45mm H: 21mm

Material: PMMA

FWHM: 15°/24°/36°/50°

(PEAK V no 50 °)

Efficiency: 90%

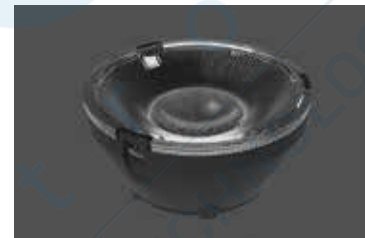

PEAK 55@25

φ: 55mm H: 25mm

Material: PMMA

FWHM: 15°/24°/36°/50°

Efficiency: 90%



PEAK 68@32

φ: 68mm H: 32mm

Material: PMMA

FWHM: 15°/24°/36°/50°

Efficiency: 90%

FILMY SERIES

A lens as thin as a cicada wing



Ultra-thin design

In the limited optical space, through triple total reflection technology, the optical path is increased to control lights effectively.

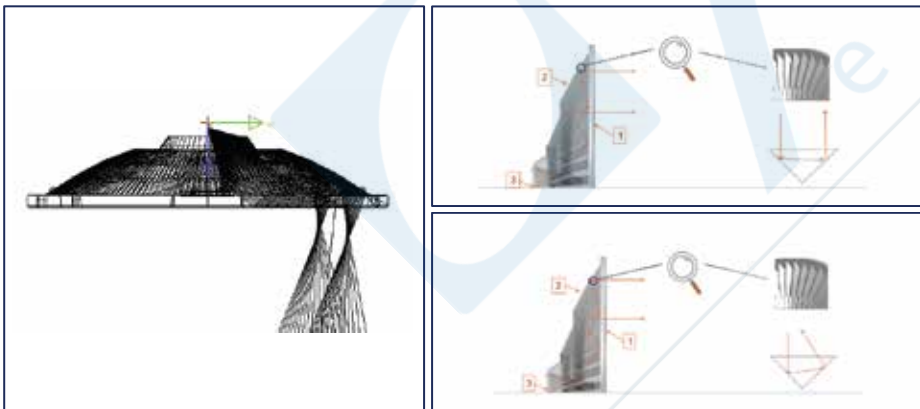

Beautiful appearance

Combining calculus with three total reflections, the lens looks like a blooming flower, which is quite exquisite as the appearance of lamps.



Triple total reflection technology: narrow angle can also match CCT changing COB

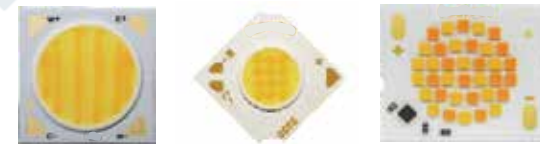

FILMY SERIES



FILMY 30@06

φ : 30mm H: 6mm
Material: PC
FWHM: 10°/15°/24°/36°/60°
Efficiency: 85%



FILMY 45@09

φ : 45mm H: 9mm
Material: PC
FWHM: 10°/15°/24°/36°/60°
Efficiency: 85%



FILMY 35@07

φ : 35mm H: 7mm
Material: PC
FWHM: 10°/15°/24°/36°/60°
Efficiency: 85%

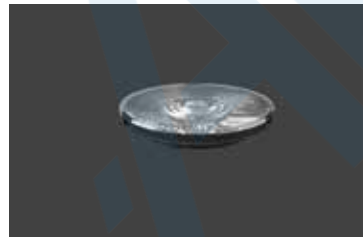

FILMY 50@10

φ : 50mm H: 10mm
Material: PC
FWHM: 10°/15°/24°/36°/60°
Efficiency: 85%



FILMY 55@11

φ : 55mm H: 11mm
Material: PC
FWHM: 10°/15°/24°/36°/60°
Efficiency: 85%



FILMY 62@13

φ : 62mm H: 13mm
Material: PC
FWHM: 10°/15°/24°/36°/60°
Efficiency: 85%



FILMY 68@13

φ : 68mm H: 13mm
Material: PC
FWHM: 10°/15°/24°/36°/60°
Efficiency: 85%

FILMY SERIES



FILMY 75@15

φ: 75mm H: 15mm
Material: PC
FWHM: 10°/15°/24°/36°/60°
Efficiency: 85%



FILMY 83@17

φ: 83mm H: 17mm
Material: PC
FWHM: 10°/15°/24°/36°/60°
Efficiency: 85%

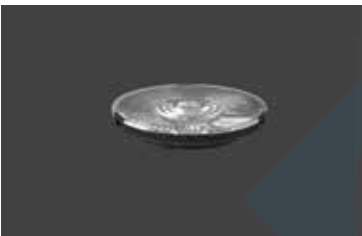

FILMY 90@18

φ: 90mm H: 18mm
Material: PC
FWHM: 10°/15°/24°/36°/60°
Efficiency: 85%



RAINBOW SERIES

A lens like an eye

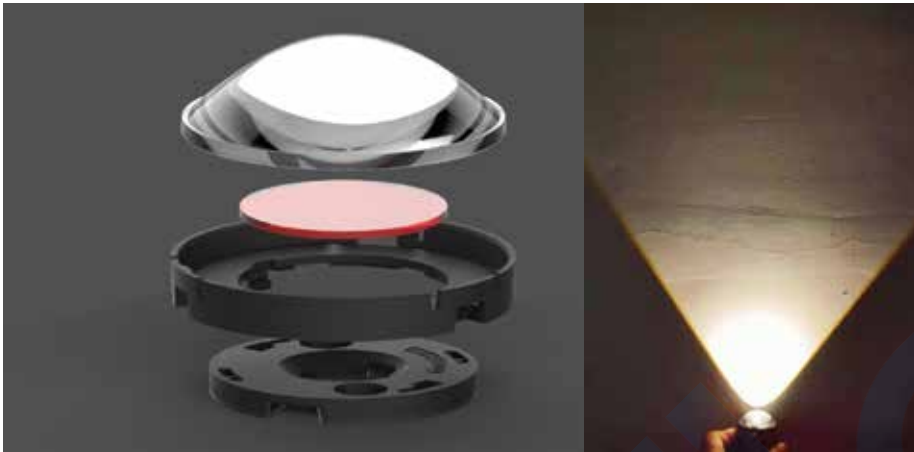

Aspherical design:

Adjust the internal structure of the convex aspherical surface to make the light spot cut-off and uniform.

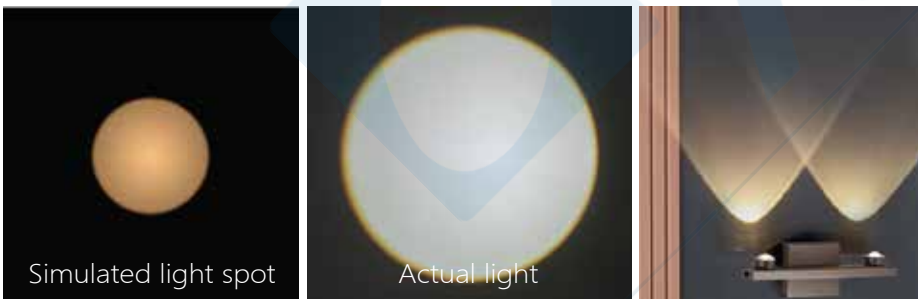

Suitable for Kirin optical platform:

The size is from 20-83mm. By using our customized lens holders, it can be assembled on our COB holders and realize a convenient replacement. It can also match with various COB brands through the corresponding COB holders.

Sunset effect:

By adding color filter, the color of the light spot can be changed to achieve different lighting effects.

There are three sizes of sunset red color-changing filters, which can be applied to sunset lights, wall lights, atmosphere lights, etc. You can also customize different colors filters according to your own needs.

The specific parameters of the color filters are as follows:

Color filter	Size	Matching optics	Matching COB holder
Ø17.8	17.8@1.1	Rainbow lens D20/D25	D24 COB holder
Ø27	27@1.1	Rainbow lens D35/D45/D50/D55/D62/D68	D35 COB holder
Ø49.8	49.8@1.1	Rainbow lens D83/D75	D50 COB holder

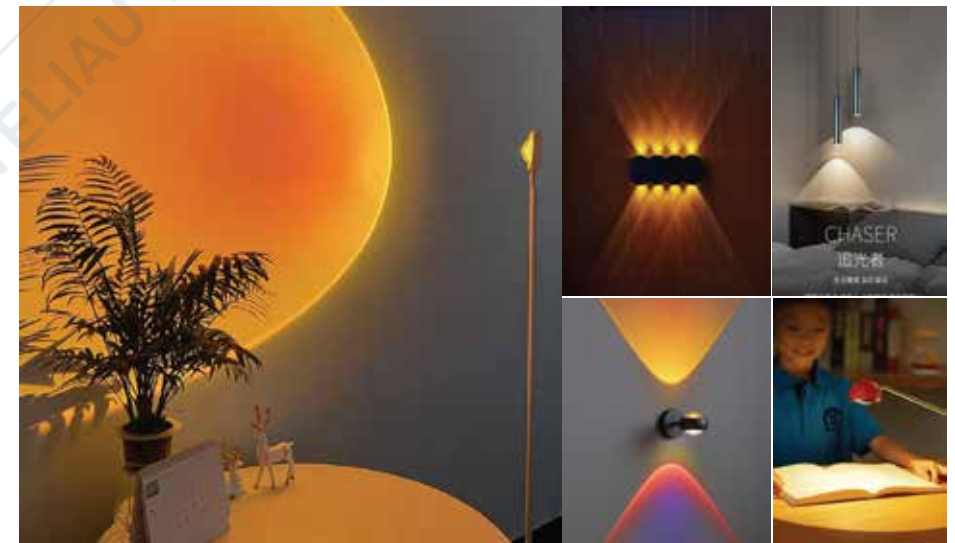

RAINBOW SERIES

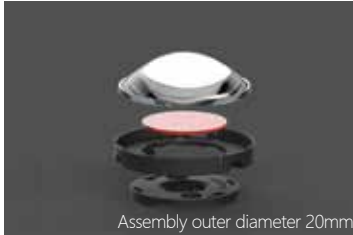

RAINBOW 18@05

φ : 18mm H: 5mm
Material: PC
FWHM: 75°
Efficiency: 88%

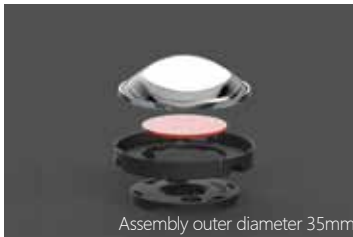

RAINBOW 32@09

φ : 32mm H: 9mm
Material: PC
FWHM: 75°
Efficiency: 88%

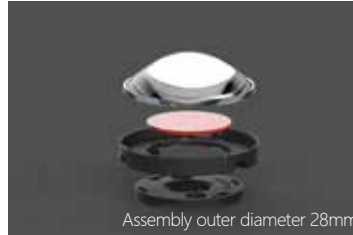

RAINBOW 25@06

φ : 25mm H: 6mm
Material: PC
FWHM: 75°
Efficiency: 88%

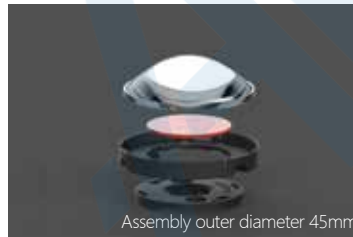

RAINBOW 42@12

φ : 42mm H: 12mm
Material: PC
FWHM: 75°
Efficiency: 88%

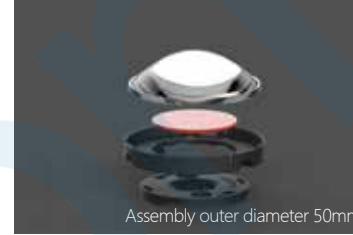

RAINBOW 47@15

φ : 47mm H: 15mm
Material: PC
FWHM: 75°
Efficiency: 88%

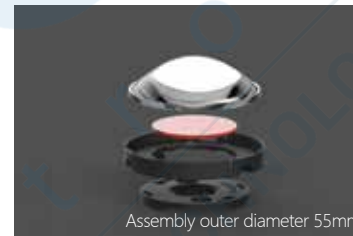

RAINBOW 52@15

φ : 52mm H: 15mm
Material: PC
FWHM: 75°
Efficiency: 88%

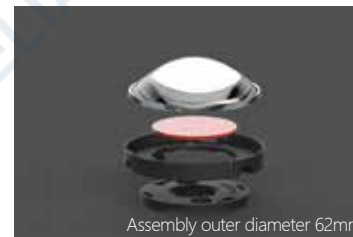

RAINBOW 58@16

φ : 58mm H: 16mm
Material: PC
FWHM: 75°/95°
Efficiency: 88%

RAINBOW SERIES

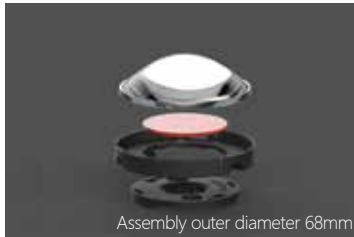

RAINBOW 64@19

φ : 64mm H: 19mm
Material: PC
FWHM: 75°
Efficiency: 88%

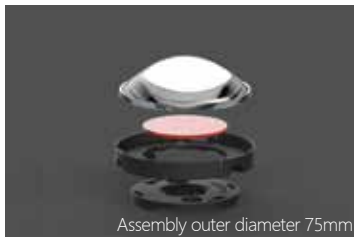

RAINBOW 71@18

φ : 71mm H: 18mm
Material: PC
FWHM: 75°
Efficiency: 88%

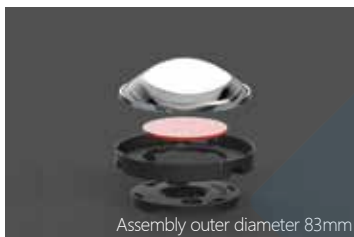

RAINBOW 79@18

φ : 79mm H: 18mm
Material: PC
FWHM: 80°
Efficiency: 88%

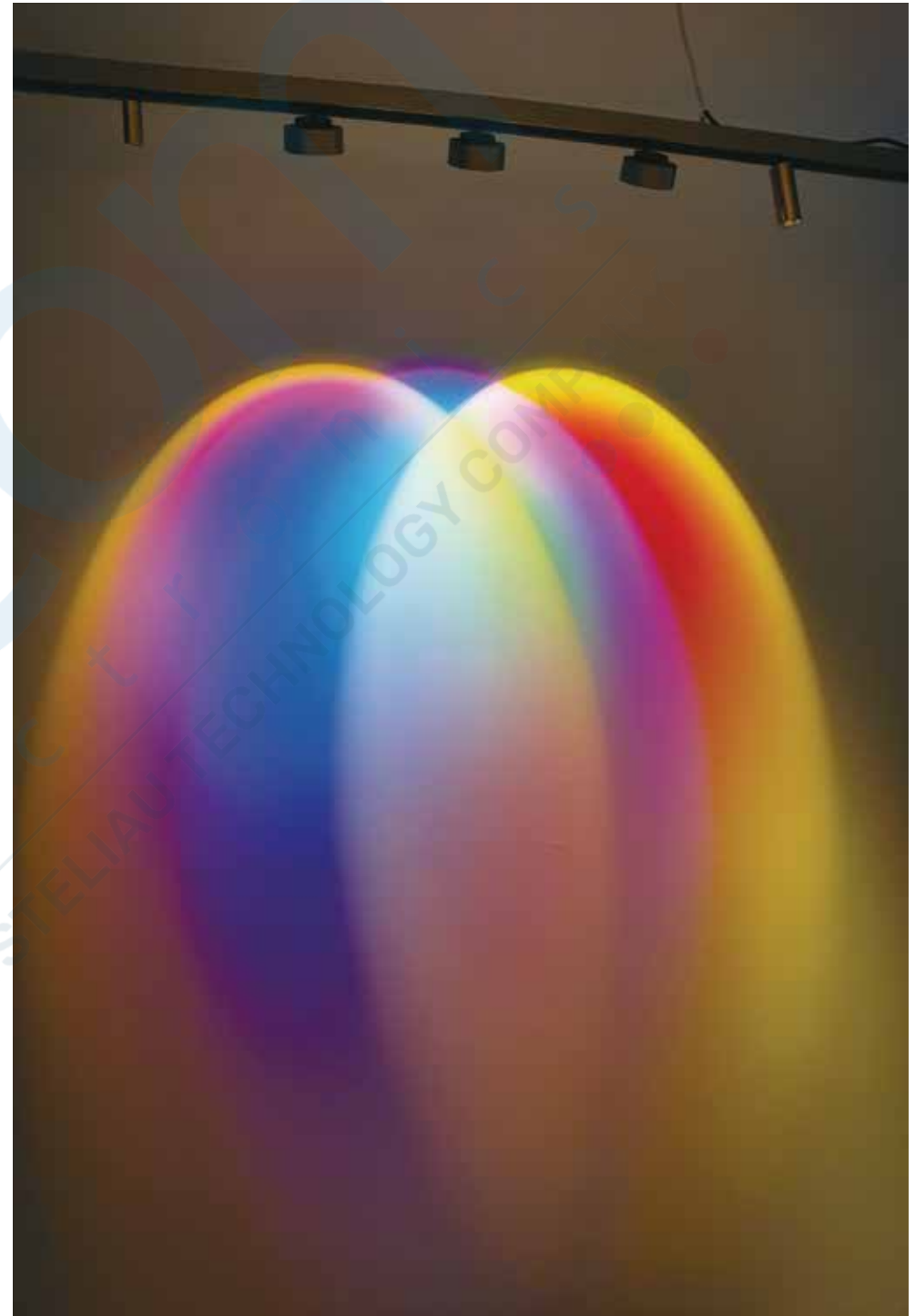

V SERIES

A reflector with anti-glare effect



- ✓ Pure reflector design, metal texture
- ✓ Develop lens holder, suitable for Kirin Optical Platform
- ✓ Light spot cut off, excessively uniform and clean

Distribute lights appropriately

In order to uniform the wall-washing lights without delamination, for reflectors of different diameters, it's necessary to accurate the reflector's height, distribute the lights appropriately, and control the lights on the reflecting surface precisely.

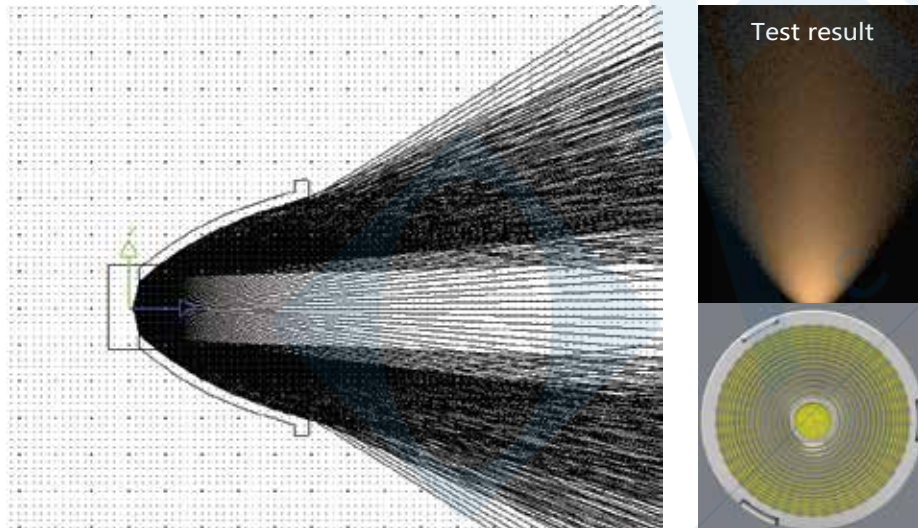

Light spot uniformity

On the basis of the reasonable distribution of the middle light and the light of the reflective surface, coupled with the reflective surface of the scaled surface differential structure, the light spot becomes more soft, and at the same time, it can be accurately controlled on the light of the reflective surface to avoid the occurrence of stratification. Dark ring and other phenomena.

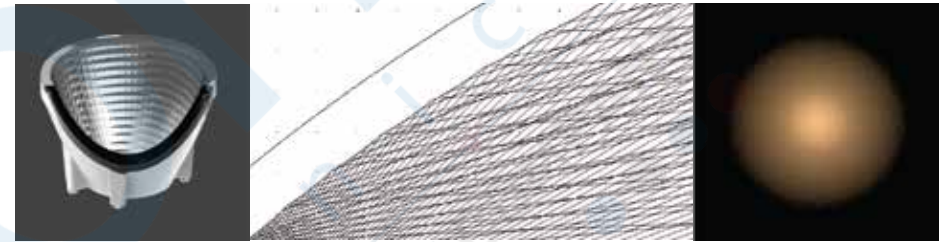

Spot contrast

Common reflector: The transition between the main spot and the side spot is uneven and there is a dark areas

HercuLux V series: The transition between the main spot and the side spot is uniform, no dark areas, and the edges are cut off

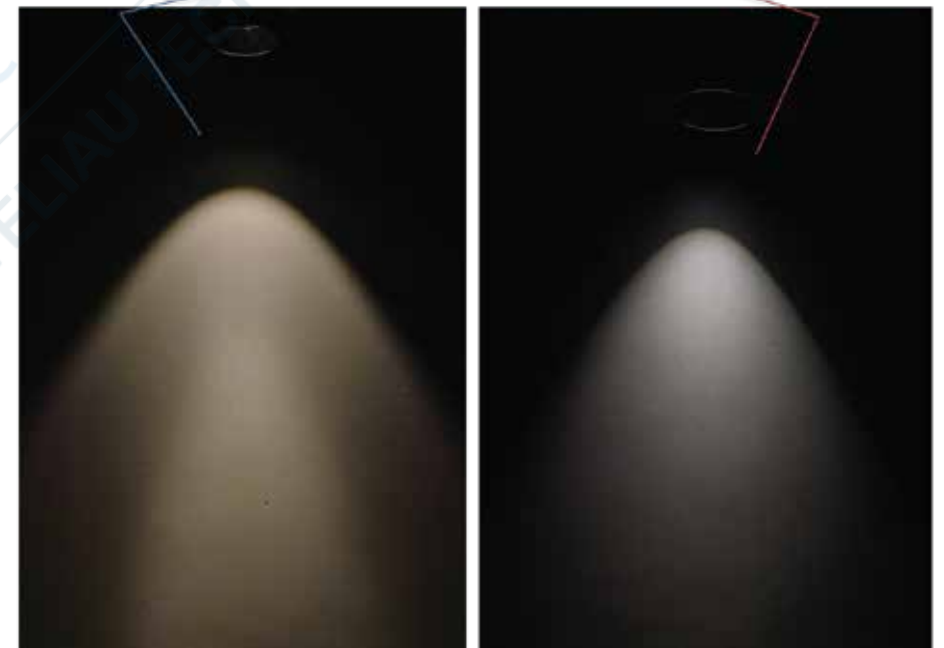

V SERIES



V 25@17

φ: 25mm H: 17mm
Material: Vaccum Aluminum Plating PC
FWHM: 15°/24°/36°/50°
Efficiency: 88%



V 30@19

φ: 30mm H: 19mm
Material: Vaccum Aluminum Plating PC
FWHM: 15°/24°/36°/50°
Efficiency: 88%



V 50@36

φ: 50mm H: 36mm
Material: Vaccum Aluminum Plating PC
FWHM: 15°/24°/36°/50°
Efficiency: 88%



V 35@23

φ: 35mm H: 23mm
Material: Vaccum Aluminum Plating PC
FWHM: 15°/24°/36°/50°
Efficiency: 88%



V 45@34

φ: 45mm H: 34mm
Material: Vaccum Aluminum Plating PC
FWHM: 15°/24°/36°/50°
Efficiency: 88%



V 55@36

φ: 55mm H: 36mm
Material: Vaccum Aluminum Plating PC
FWHM: 15°/24°/36°/50°
Efficiency: 88%



V 62@41

φ: 62mm H: 41mm
Material: Vaccum Aluminum Plating PC
FWHM: 15°/24°/36°/50°
Efficiency: 88%

V SERIES



V 68@45

φ: 68mm H: 45mm
Material: Vaccum Aluminum Plating PC
FWHM: 15°/24°/36°/50°
Efficiency: 88%



V 75@47

φ: 75mm H: 47mm
Material: Vaccum Aluminum Plating PC
FWHM: 15°/24°/36°/50°
Efficiency: 88%



V 83@60

φ: 83mm H: 60mm
Material: Vaccum Aluminum Plating PC
FWHM: 15°/24°/36°/50°
Efficiency: 88%

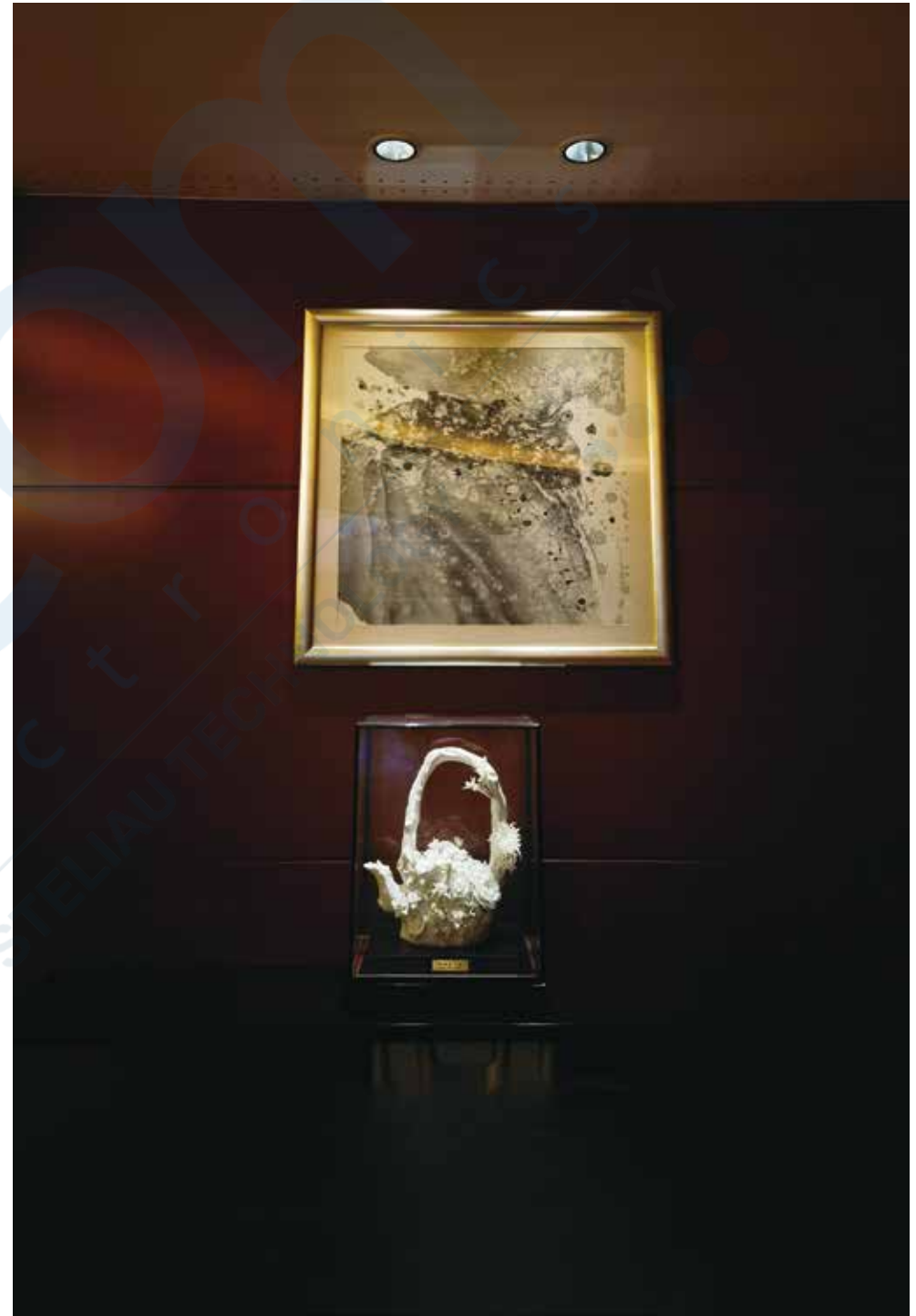

ZOOM MODULE

The main zoom product in the Kirin Optical Platform, zoom without changing sizes

The zoom module is composed of a lens, a lens holder, and a fixed holder, where in the lens holder drives the lens to move back and forth in the fixed holder to realize the change of the focal length of the lens relative to the position of the LED, thereby realizing the change of the angle. In the zoom module development plan, the outer diameter is consistent with other dimensions of the Kirin Optical Platform. The total planned outer diameters are 30, 35, 45, 50, 55, 62, 75.

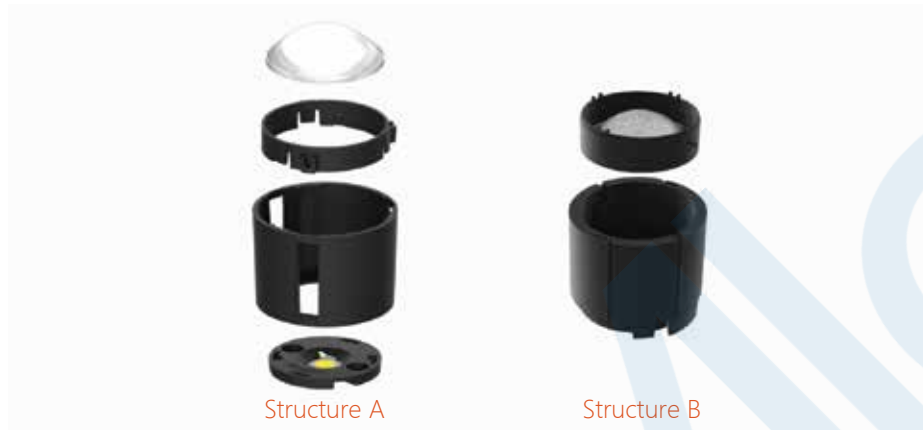

Easy install

After the customer gets the zoom module, they only need to add a zoom connection structure and fix it on the lens holder with screws, that is, the module can be rotated on the Kirin Optical Platform holder, and the front part of the lamp can be completed by adding the lamp shell, and the structure is simple.



Fermat microstructure design

The convex lens is partially designed with Fermat microstructure, which makes the overall light spot soft and cut off, and the transition light spot is more natural.

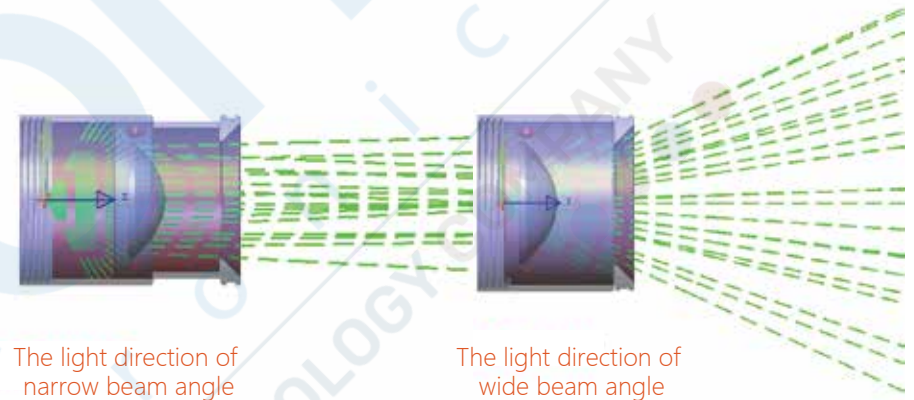

Anti-glare effect

The zoom module has an anti-glare angle of 38° itself, and the anti-glare angle remains unchanged during the entire zooming process, so that the zoom module can achieve excellent anti-glare effect at all angles. The following pictures are the real shot effect of the small, medium and large angle.



ZOOM MODULE

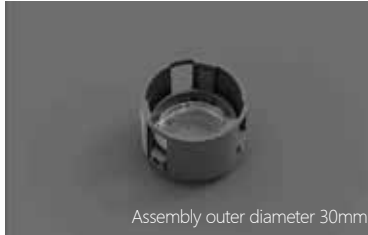

ZOOM 22@06

φ: 22mm H: 6mm
Material: PC
FWHM: 10°~45°
Efficiency: /

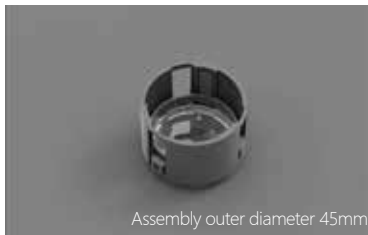

ZOOM 37@12

φ: 37mm H: 12mm
Material: PC
FWHM: 10°~45°
Efficiency: /

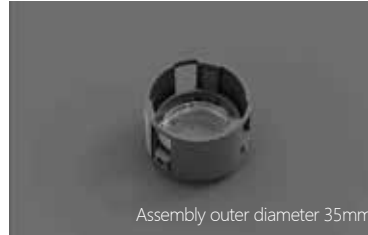

ZOOM 27@08

φ: 27mm H: 8mm
Material: PC
FWHM: 10°~45°
Efficiency: /

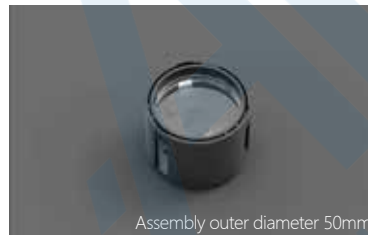

ZOOM 42@13

φ: 42mm H: 13mm
Material: PC
FWHM: 10°~45°
Efficiency: /

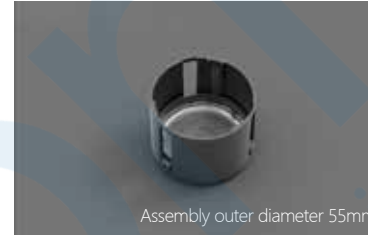

ZOOM 47@15

φ: 47mm H: 15mm
Material: PC
FWHM: 10°~45°
Efficiency: /



ZOOM 54@16

φ: 54mm H: 16mm
Material: PC
FWHM: 10°~45°
Efficiency: /



ZOOM 65@19

φ: 65mm H: 19mm
Material: PC
FWHM: 10°~45°
Efficiency: /

MAVIC & MAVIC PRO

A lens with ultra small size and clean light spot



Mavic

Mavic Pro

Same base, consistent with the screw hole position of the Qilin platform D35 light source bracket.

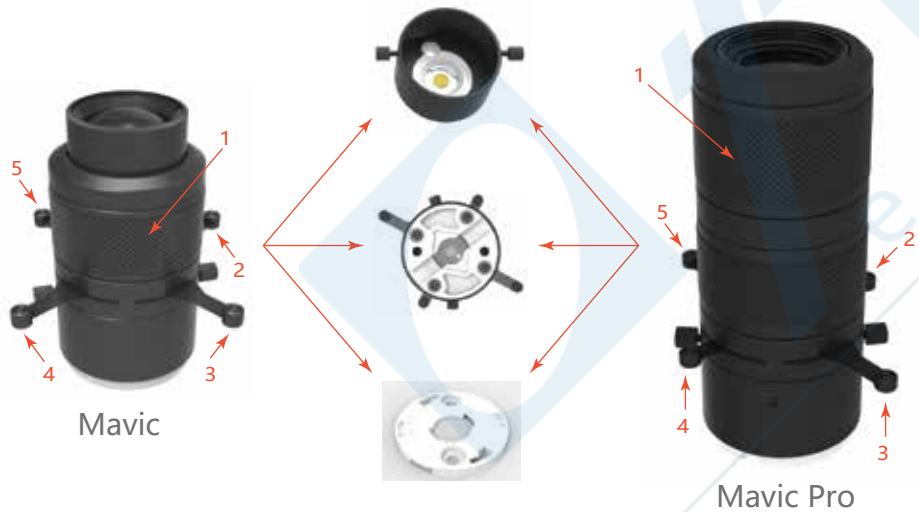

Mavic

Mavic Pro

Suitable for monochrome and bicolor light sources smaller than 6mm.



Can adjust to any shape and rotate 360 degrees.



Adjust by rotating 1

Adjust by adjusting 2/3/4/5 or rotating 1

High precision, can show more details.



MAVIC & MAVIC PRO

Easy assembly and strong compatibility

Step 1: Unscrew the screws and replace the conventional light source bracket 6.
 Step 2: Install component 7 directly onto the light source and lock the screws.
 Step: Install component 8 onto component 7, with the screws on the side of the screws.



The lens can rotate 360 degrees and can be used for logos

Loosen the hand screws 9 on both sides, and the lamp 8 can rotate 360° around accessory 7, making it flexible and adaptable to the needs of multiple views and angles. It can also be used for logo lights, and the logo sheet needs to be customized separately.

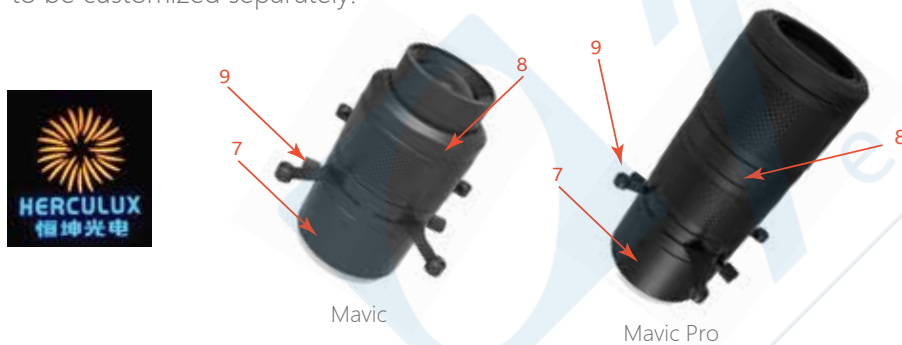

Differences: Different projection ratios

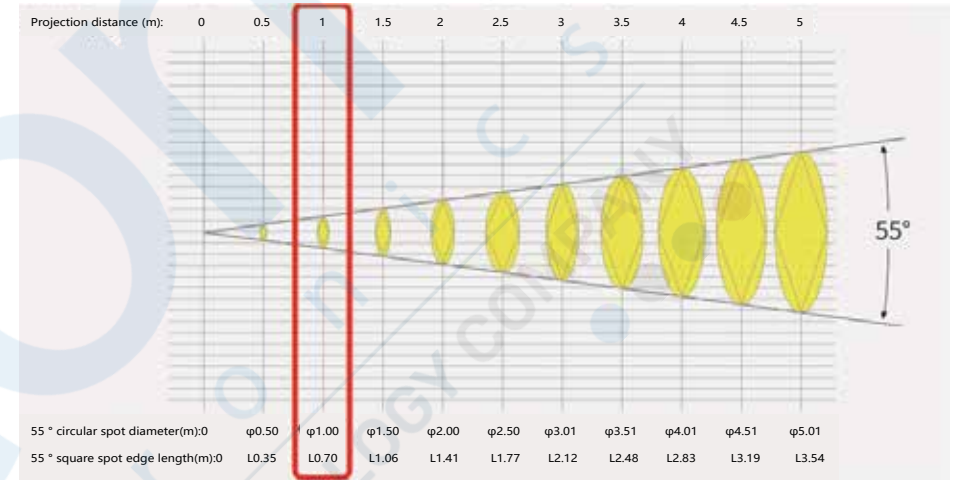

Mavic : Circular spot diameter at 1 meter: 1 meter

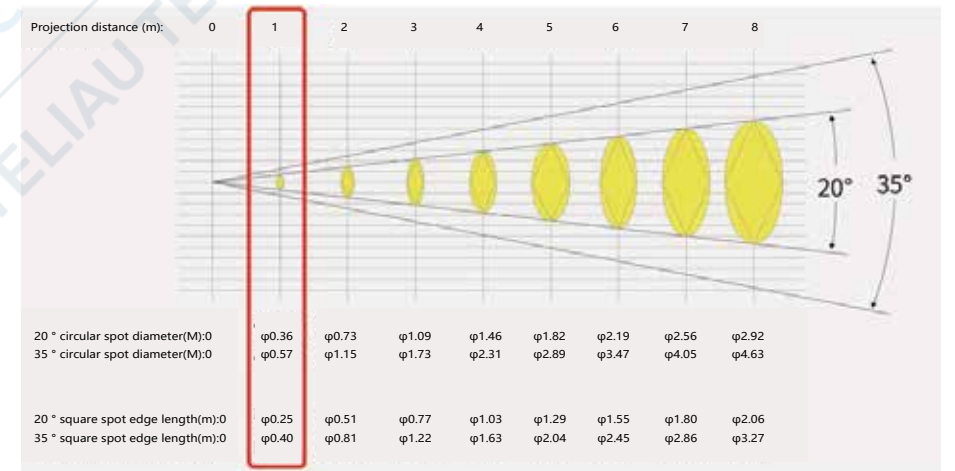

Mavic Pro : Spot diameter at 1 meter: 0.36-0,57 meters.

The spot size of Mavic Pro is adjustable

KA PRO SERIES

The KA Pro is a major upgrade based on Calculus technology. Compared to the KA series, the KA pro offers a significant increase in main center light intensity and efficiency.



KA Pro Product Features

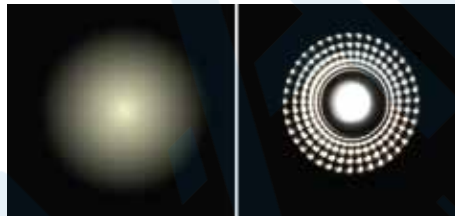
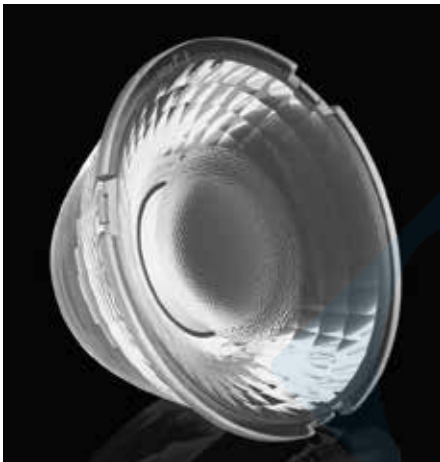

- ✓ Calculus technology with uniform spot and cut-off
- ✓ High light intensity in the main center
- ✓ Higher light efficiency
- ✓ Superior color mixing ability
- ✓ Perfectly adapted to Kirin Optical Platform

Color mixing ability:

The reflective surface adopts calculus technology, so that the lens can match with CCT changing COB, and the spot is more uniform.

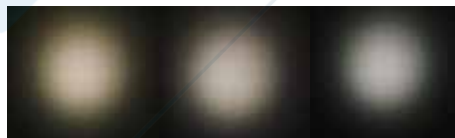

Test Situation

Series	Diameter	Height	Materials	Angle	K-value	Efficiency
KA-Pro series	50	24	PMMA	24°	5.3	93.7%
KA series				24°	4.6	92.8%
KA-Pro series				36°	3.0	94.3%
KA series				36°	2.5	91.3%

Matching filter

KA PRO series, matched with different variable filter to realize different lighting effects, single asymmetric, double asymmetric, linear, wall wash, transparent filter. Track light + wall washer, suitable for track light fixtures, no need to add deeper light hood.

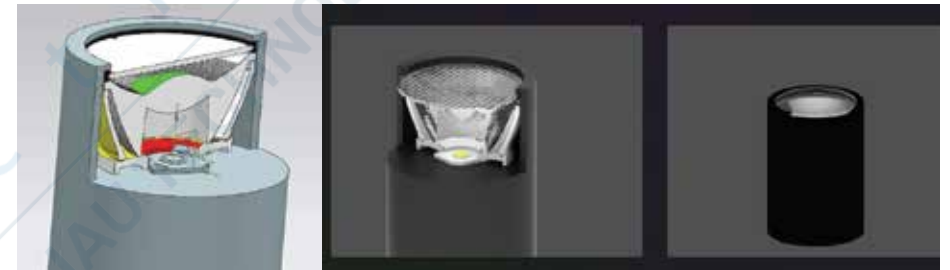

Comparison Application

Luminaire spacing	1M	1M	1M
Distance from wall	1M	1M	1M
Wall height	3.6M	3.6M	3.6M
Base lens	12°	24°	36°
Luminaire Offset Angle	35	35	35
Light distribution curve			

KA PRO SERIES



KA PRO 30@16

φ: 30mm H: 16mm
Material: PMMA
FWHM: 15°/24°/36°/50°
Efficiency: 92%



KA PRO 45@16

φ: 45mm H: 16mm
Material: PMMA
FWHM: 15°/24°/36°/60°
Efficiency: 92%



KA PRO 35@12

φ: 35mm H: 12mm
Material: PMMA
FWHM: 15°/24°/36°/60°
Efficiency: 92%

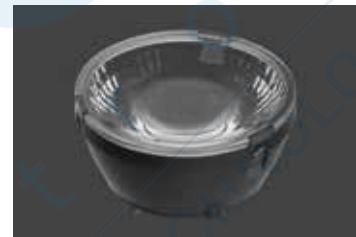

KA PRO 50@16

φ: 50mm H: 16mm
Material: PMMA
FWHM: 15°/24°/36°/60°
Efficiency: 92%



KA PRO 40@13

φ: 40mm H: 13mm
Material: PMMA
FWHM: 15°/24°/36°/60°
Efficiency: 92%



KA PRO 55@21

φ: 55mm H: 21mm
Material: PMMA
FWHM: 15°/24°/36°/60°
Efficiency: 92%

KA PRO SERIES



KA PRO 62@24

φ: 62mm H: 24mm
Material: PMMA
FWHM : 15°/24°/36°/60°
Efficiency: 92%



KA PRO 68@25

φ: 68mm H: 25mm
Material: PMMA
FWHM: 15°/24°/36°/60°
Efficiency: 92%



KA PRO 75@30

φ: 75mm H: 30mm
Material: PMMA
FWHM: 15°/24°/36°/60°
Efficiency: 92%



KA PRO 83@32

φ: 83mm H: 32 mm
Material: PMMA
FWHM: 15°/24°/36°/60°
Efficiency: 92%



MOONY PRO SERIES

Hard grazing wall

Grazing wall as a unique category (no sub-light spots, clear light and shadow, sharp spots, layered) gives users a unique experience and is loved by many users. Some users prefer hard grazing wall, but others favor soft grazing wall.

The Moony Pro Series (soft grazing wall) and Peak Pro Series (hard grazing wall) are great additions to the Kirin Optical platform, offering more beautiful designs and personalized needs for the field of home lighting without main lights.



COB Compatible

Both regular color temperatures and dual-color temperature light sources on the market can be compatible, easily controlled.

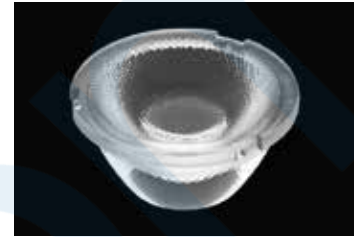
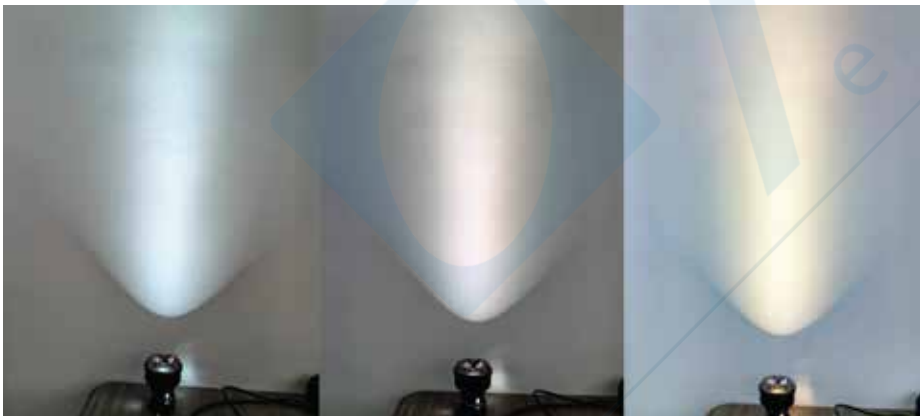

MOONY PRO 28@13

φ: 28mm H: 13mm
Material: PC
FWHM: 15°/24°/36°/50°
Efficiency: 88%

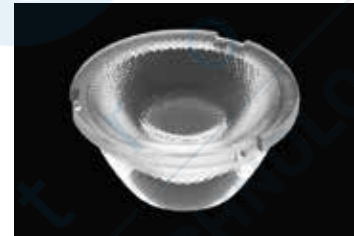

MOONY PRO 35@18

φ: 35mm H: 18mm
Material: PC
FWHM: 15°/24°/36°/50°
Efficiency: 88%

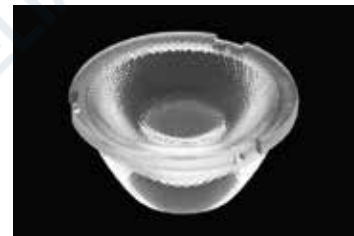

MOONY PRO 45@21

φ: 45mm H: 21mm
Material: PC
FWHM: 15°/24°/36°/50°
Efficiency: 88%

PEAK PRO SERIES

Soft grazing wall

Grazing wall as a unique category (no sub-light spots, clear light and shadow, sharp spots, layered) gives users a unique experience and is loved by many users. Some users prefer hard grazing wall, but others favor soft grazing wall.

The Moony Pro Series (soft grazing wall) and Peak Pro Series (hard grazing wall) are great additions to the Kirin Optical platform, offering more beautiful designs and personalized needs for the field of home lighting without main lights.



COB Compatible

Both regular color temperatures and dual-color temperature light sources on the market can be compatible, easily controlled.

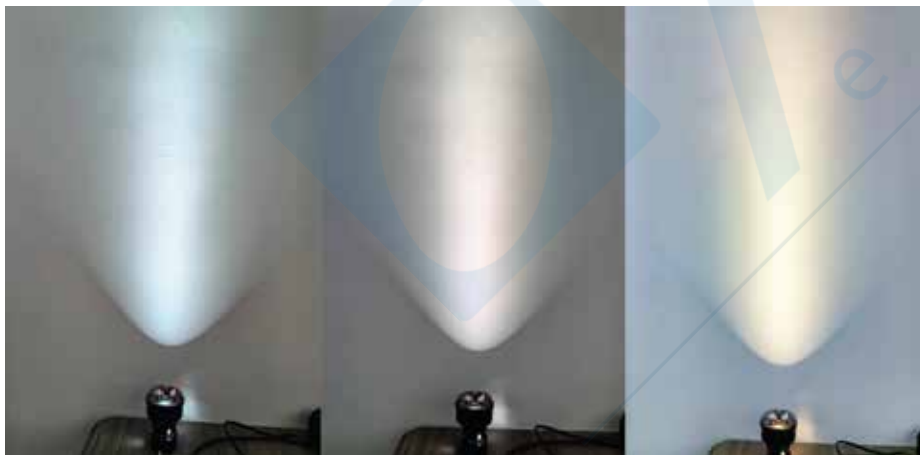

PEAK PRO 28@14

φ: 28mm H: 14mm
Material: PC
FWHM: 15°/24°/36°/50°
Efficiency: 88%



PEAK PRO 35@17

φ: 35mm H: 17mm
Material: PC
FWHM: 15°/24°/36°/50°
Efficiency: 88%



PEAK PRO 45@21

φ: 45mm H: 21mm
Material: PC
FWHM: 15°/24°/36°/50°
Efficiency: 88%

SOFTY SERIES

Advantages of silicone lens

- √ High Temp, 200°C up can be used in high-power lamps.
- √ Zero InnerStress, completely prevent stress cracking.
- √ High Molding Accuracy, molecular-level replication between the silicone and the mold, surface precision can achieve μ -level.
- √ High toughness, the material is soft and elastic, making it easy to form and unmold complex structures.
- √ High weatherability, HercuLux self-innovate silicon, high aging resistance, yellowing resistance and optical stability, long service life.
- √ Recyclable, liquid silicone can be recycled into silicone oil, environmentally friendly.
- √ Same dimensions as all Kirin platform, and can be directly interchanged.

Long service life: In the process of synthesizing Silicone, we strictly control the content of chloride ions in the silicone resin, controlling it to be less than 1 ppm, and allow the platinum salt initiator to fully react during the synthesis. So the degree of yellowing of our silicone lenses is almost negligible!

How to verify the yellowing resistance of silicone lens: leave it at 150°C for more than 240 hours to verify its anti-yellowing performance. Comparison of HercuLux silicone lens and other brands after being placed in a 150°C environment for 500 hours.

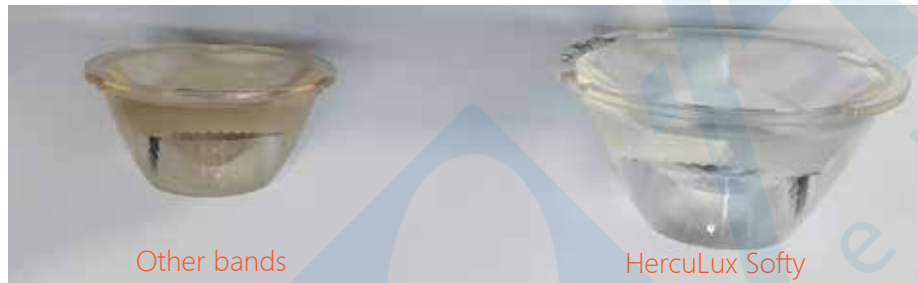

SOFTY 20@11

φ : 20mm H: 11mm
Material: Silicone
FWHM: 15°/24°/36°/50°
Efficiency: 94%

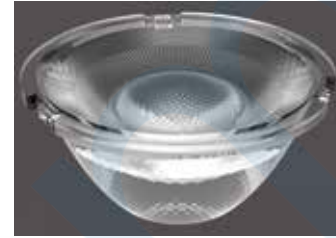

SOFTY 25@13

φ : 25mm H: 13mm
Material: Silicone
FWHM: 24°/36° (15°/50°developing)
Efficiency: 94%

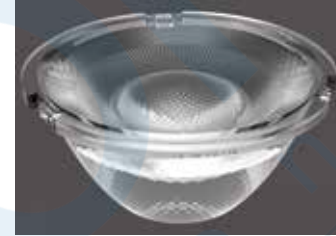

SOFTY 35@16

φ : 35mm H: 16mm
Material: Silicone
FWHM: 24° (15°/36°/50°developing)
Efficiency: 94%

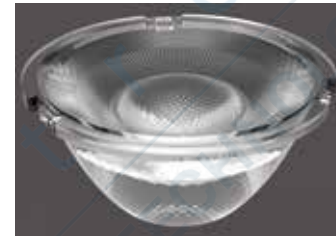

SOFTY 45@21

φ : 45mm H: 21mm
Material: Silicone
FWHM: 24°/36° (10°/15°/50°developing)
Efficiency: 94%



SOFTY 62@30

φ : 62mm H: 30mm
Material: Silicone
FWHM: 24° (15°/36°/50°developing)
Efficiency: 94%



SOFTY 83@40

φ : 83mm H: 40mm
Material: Silicone
FWHM: 24° (15°/36°/50°developing)
Efficiency: 94%

Standard products are under continuous development and can be customised.

FIREFLY-KIRIN SERIES

Development Background

At present, in commercial lighting and hotel lighting, there are very few optics with good color mixing, especially nowadays, it is difficult to guarantee the spot quality after the color COB comes out, and secondly, the spot quality is not good, and It's very harsh.

Firefly-Kirin series, using Herculux patented "Light cone correction technology" technology. Comply with Zhaga standard, super color mixing ability.

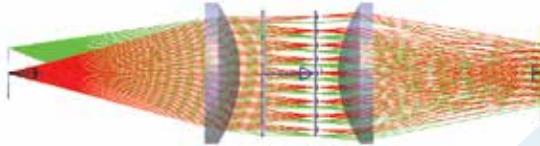

Light cone correction technology, The design concept comes from imaging optics, which combines imaging optics with energy optics. To achieve the following two objectives:
 1: Uniform irradiance on the exit surface.
 2: Expanding LEDs from point light sources to surface light sources.

Conforms to Zhaga standards:

From the time of project approval, we require the design of the whole series of products to meet the pin to pin replacement with Kirin optical platform products, fully in line with Zhaga standards.



Superb color mixing ability and ultra-high center light intensity:

Herculux's patented "light cone correction technology" achieves excellent color uniformity, high illuminance uniformity on the lens surface to achieve high CBCP, excellent light distribution angle and ultra-low glare performance.



Parameter comparison:

Test conditions	COB: 6mm Tunable CCT COB			Power:7.1W		
Product series	Angle(50%)	Angle(10%)	LM	CBCP	K value	Efficiency
Firefly-Kirin φ35-24°	23.9	42.7	564LM	2739CD	4.85	86%
Other bands φ35-24°	24.9	44.4	552LM	2251CD	4.07	84%
Firefly-Kirin φ35-36°	35.7	57	554LM	1428CD	2.57	85%
Other bands φ35-36°	35.6	60.7	541LM	1236CD	2.28	83%
Firefly-Kirin φ35-60°	59.8	78	558LM	596CD	1	85%
Other bands φ35-60°	52.9	93.6	483LM	518.8CD	1.07	74%

Spot Comparison:



FIREFLY-KIRIN SERIES



FIREFLY-KIRIN 28@19

φ: 28mm H: 19mm
Material: PMMA+Vaccum Aluminum
Plating PC
FWHM: 24°/36°/60°
Efficiency: 92%



FIREFLY-KIRIN 33@17

φ: 30mm H: 17mm
Material: PMMA+Vaccum Aluminum
Plating PC
FWHM: 24°/36°/60°
Efficiency: 92%



FIREFLY-KIRIN 35@25

φ: 35mm H: 25mm
Material: PMMA+Vaccum Aluminum
Plating PC
FWHM: 24°/36°/60°
Efficiency: 92%

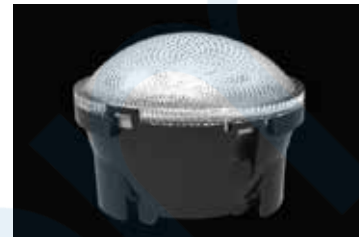

FIREFLY-KIRIN 40@30

φ: 40mm H: 30mm
Material: PMMA+Vaccum Aluminum
Plating PC
FWHM: 24°/36°/60°
Efficiency: 92%



FIREFLY-KIRIN 45@34

φ: 45mm H: 34mm
Material: PMMA+Vaccum Aluminum
Plating PC
FWHM: 24°/36°/60°
Efficiency: 92%



FIREFLY-KIRIN 50@38

φ: 50mm H: 38mm
Material: PMMA+Vaccum Aluminum
Plating PC
FWHM: 24°/36°/60°
Efficiency: 92%



FIREFLY-KIRIN 55@39



φ: 55mm H: 39mm
Material: PMMA+Vaccum Aluminum
Plating PC
FWHM: 24°/36°/60°
Efficiency: 92%

COB HOLDER

Can buckle with the lens holder; Same COB holder can match different COB Substrate size and COB brand.

	
	
D35 COB HOLDER	
Outer diameter	35mm
Hight	3.5mm
Screw holde distance	25mm
Type	18
Matchable potics	
Series	Optical diameter
Dark series	D25/D30/D35/D45/D50/D55/D62/D68
Glareless series	D25/D30/D35/D45/D50/D55/D62/D68
Gemini series	D25/D30/D35/D45/D50/D55/D62/D68
Moony series	D25/D30/D35/D45/D50/D55/D62/D68
Peak series	D30/D35/D45/D50/D55/D62/D68
Filmy series	D30/D35/D45/D50/D55/D62/D68
V series	D30/D35/D45/D50/D55/D62/D68
Rainbow series	D35/D45/D50/D55/D62/D68
Zoom Module	D35/D45/D50

Meet the assembly standards of ZHAGA. Interchangeable with solder free brackets such as BJB,with consistent outer diameter,screw positioning,and rotating interface.

	
	
D24 COB HOLDER	
Outer diameter	24mm
Hight	3.4mm
Screw holde distance	19mm
Type	6
Matchable potics	
Series	Optical diameter
Dark series	D25/D30/D35
Glareless series	D25/D30/D35
Gemini series	D25/D30/D35
Moony series	D25/D30/D35
Peak series	D25/D30/D35
Filmy series	D30
V series	D35

	
	
D50 COB HODER	
Optical diameter	50mm
Hight	5.2mm
Screw holde distance	35mm
Type	13
Matchable potics	
Series	Optical diameter
Dark series	D75/D83
Glareless series	D75/D83
Gemini series	D75/D83
Moony series	D75/D83
Peak series	D75/D83
Filmy series	D75/D83
V series	D75/D83
Rainbow series	D75/D83
Zoom Module	D75/D83

LENS HOLDER

Twisting method, can be rotated with BJB solderless holder and other ZHAGA solderless holders. Three colours, different colours, different effects.
Size: $\varphi 45/\varphi 50/\varphi 55/\varphi 62/\varphi 68/\varphi 75$

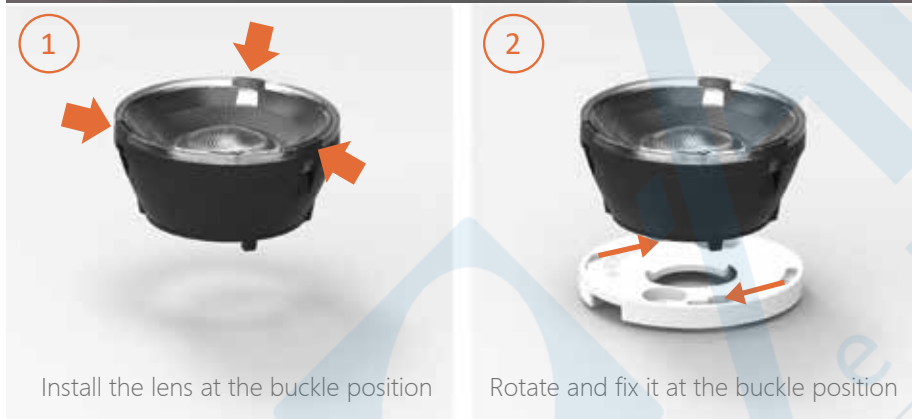

Test Comparison:

Test condition: $\varphi 45$; Test COB: $\varphi 9$

	Black	White	Crystal	Black	White	Crystal	Black	White	Crystal	Black	White	Crystal	Black	White	Crystal
Standard angle(°)	10			15			24			36			50		
Measured angle(°)	18.1	18.1	17.9	18.8	18.7	18.4	23.3	23.2	22.9	35.9	35.9	35.4	51.9	51	50.4
K value(cd/lm)	8.04	6.97	7.01	6.68	6.25	6.26	5.35	5.09	5.18	2.74	2.62	2.69	1.36	1.37	1.38
Efficiency	63.85%	74.33%	73.13%	90.61%	92.59%	91.37%	90.61%	95.63%	94.81%	88.71%	93.17%	92.32%	88.81%	94%	92.34%

UGR Comparison:



自研UGR数据对比表												自研UGR数据对比表												自研UGR数据对比表											
测试条件	测试角度	测试距离	测试高度	测试直径	测试面积	测试功率	测试流明	测试照度	测试亮度	测试眩光	测试对比度	测试色温	测试显色	测试效率	测试寿命	测试成本	测试维护	测试应用	测试备注	测试日期	测试人员														
UGR 14.4	10°	1.0m	1.5m	45mm	1590mm²	10W	1000lm	6.3cd/m²	18.1°	14.4	1.0	2700K	90	90%	50000h	0.5元	简单	工业照明	测试通过	2023-10-27	张三														
UGR 8.5	10°	1.0m	1.5m	45mm	1590mm²	10W	1000lm	6.3cd/m²	8.5°	8.5	1.0	2700K	90	90%	50000h	0.5元	简单	工业照明	测试通过	2023-10-27	张三														
UGR 5	10°	1.0m	1.5m	45mm	1590mm²	10W	1000lm	6.3cd/m²	5°	5	1.0	2700K	90	90%	50000h	0.5元	简单	工业照明	测试通过	2023-10-27	张三														

Glare Comparison:

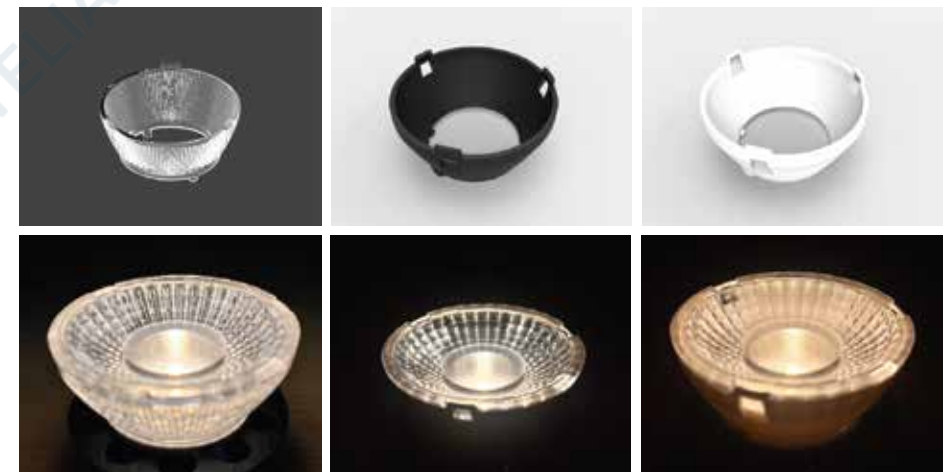

LIGHT FILTER

6 types of Filter for the Kirin platform

Linear/ Single Asymmetric/ Double Asymmetric/ Wall Washing/ Transparent / Heavy/Light Matte

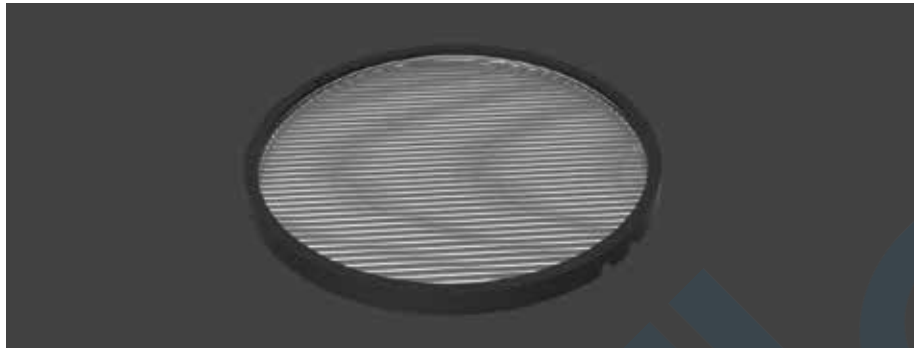

Identification of Filter

Filter can be identified by the naked eye. Transparent: has a smooth and shiny surface on both sides. Light /Heavy Matte: while the soft has a smooth and shiny surface on both sides. Single Asymmetric: has the words "SA-UP" marked on the surface. Double Asymmetric: the double polarizer has the words "DA-UP" marked on the surface. Linear: has the words "60XX-UP" marked on the surface. Wall washing: has the words "XQ" marked on the surface.

transparent surface	Matte surface	SA-UP	DA-UP	60XX-UP	XQ
Transparent	Light Matte	Single Asymmetric	Double Asymmetric	Linear	Wall washing

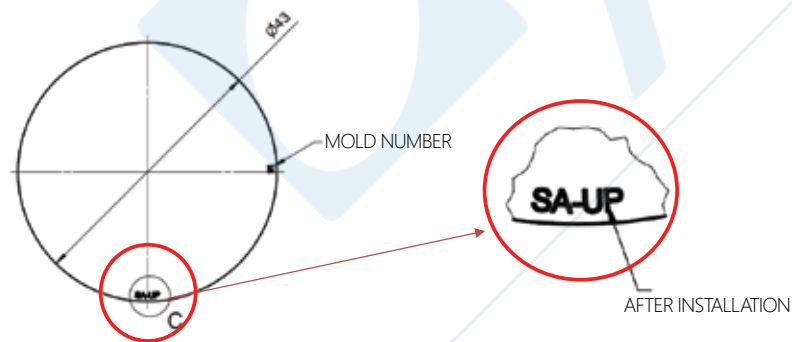

Installation method

The transparent and light&heavy matte without optical structure can be installed directly, while Linear, Asymmetric, double Asymmetric, and wall washing filter with optical structure need to be installed with the smooth surface facing up, and the direction with the words SA-UP/DA-UP/60XX-UP-/XQ is the direction of the light spot .

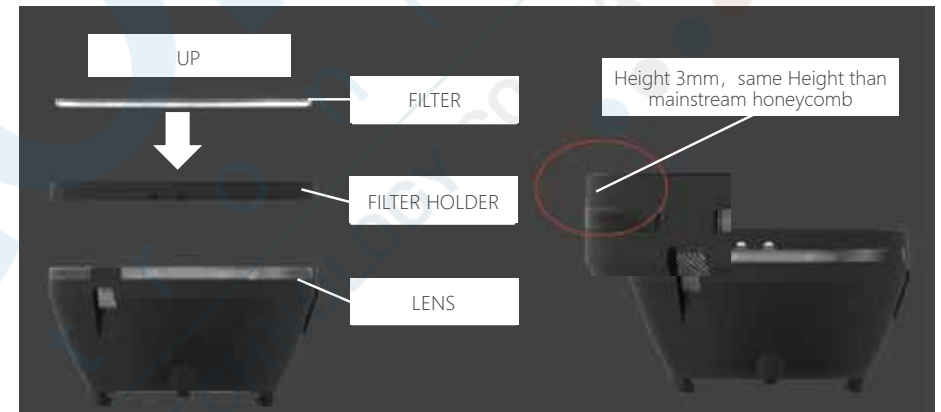

Application

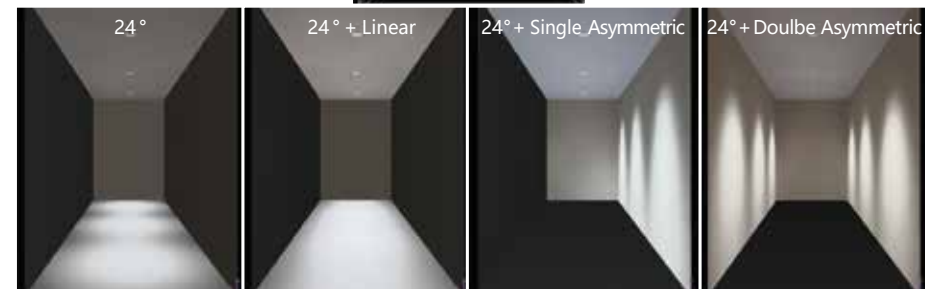
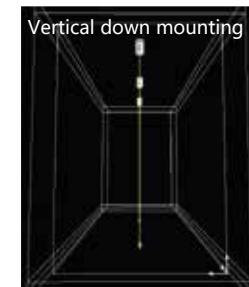

LIGHT FILTER

Different filters with different lenses will get different spot effects.

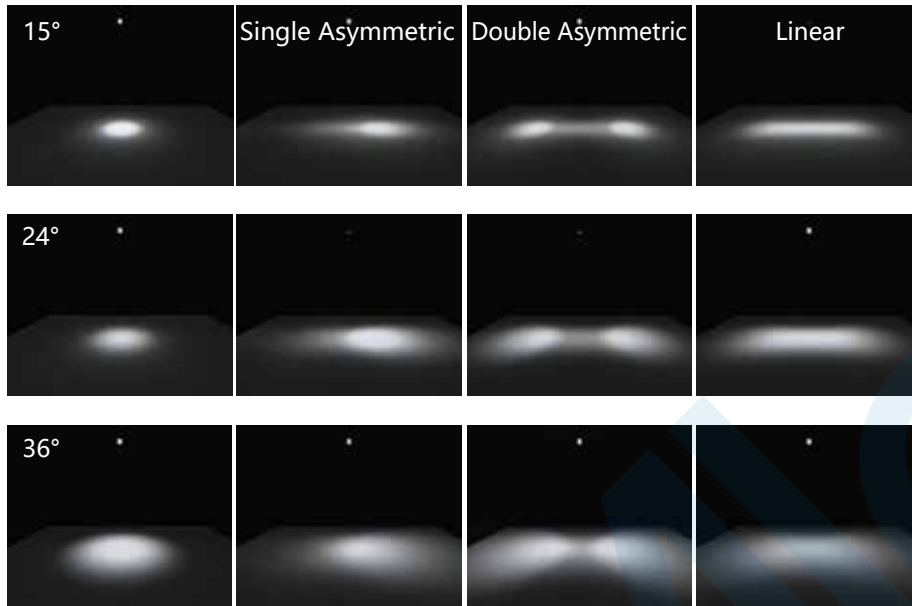

Wall washing filter

Suitable for track lighting fixtures without deepened anti-glare louver.



Lens Effects

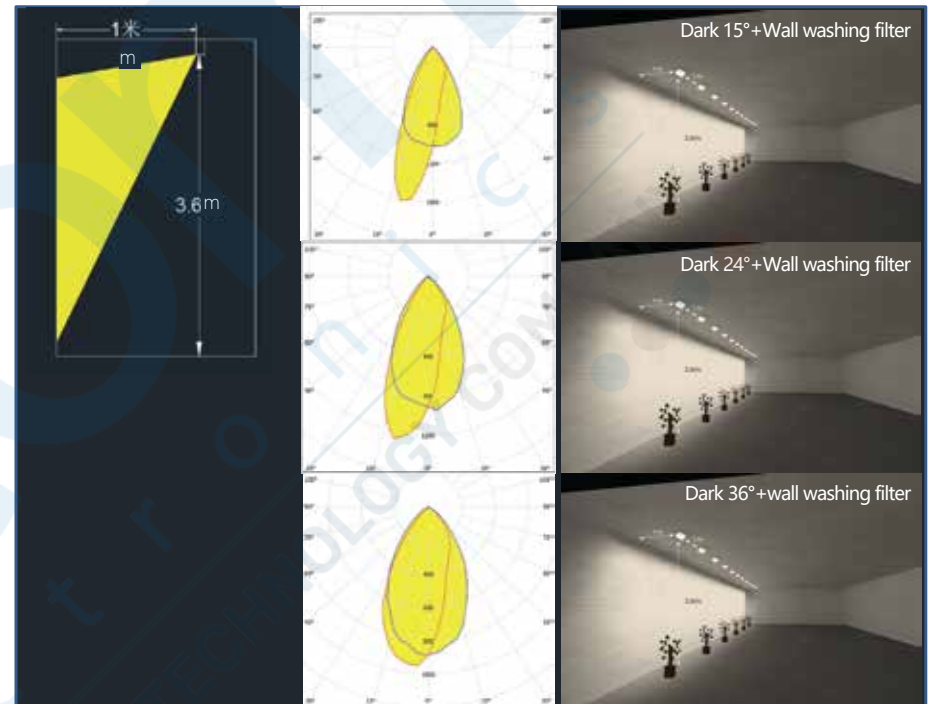

Size

For the Kirin Optical Platform series products, corresponding size-variable lenses have been developed. Specific sizes include: $\varnothing 25$, $\varnothing 30$, $\varnothing 35$, $\varnothing 45$, $\varnothing 50$, $\varnothing 55$, $\varnothing 62$, $\varnothing 68$, $\varnothing 75$, and $\varnothing 83$, with support for customized development. The embedded ring height for variable lenses of different sizes is 3mm. The actual diameter and height of the variable lenses are slightly smaller than the corresponding embedded ring sizes.



LIGHT HOOD

Various types are choosable

Small hole hood, oblique hole hood, flat hood, wall washing hood Various forms of hoods, switch at will. The installation method is the same, can be switched at will.

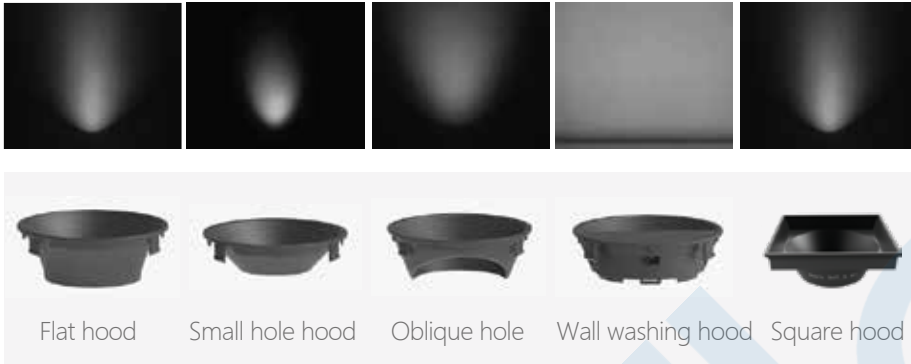

Multiple colors available and customizable

There are currently four colors available: bright black, bright gold, bright silver, and matte black. Customization of other colors is also acceptable.



Small hole hood

The cross-light design principle makes the light output hole of the lamp smaller than the optical diameter. With the small hole hood, it can be hidden deeper, the glare can be better controlled, and the optical efficiency has little effect, and the light spot effect can be guaranteed. The small hole hood perfectly solves the phenomenon of butterfly spots when deflecting the wall and washing the wall.

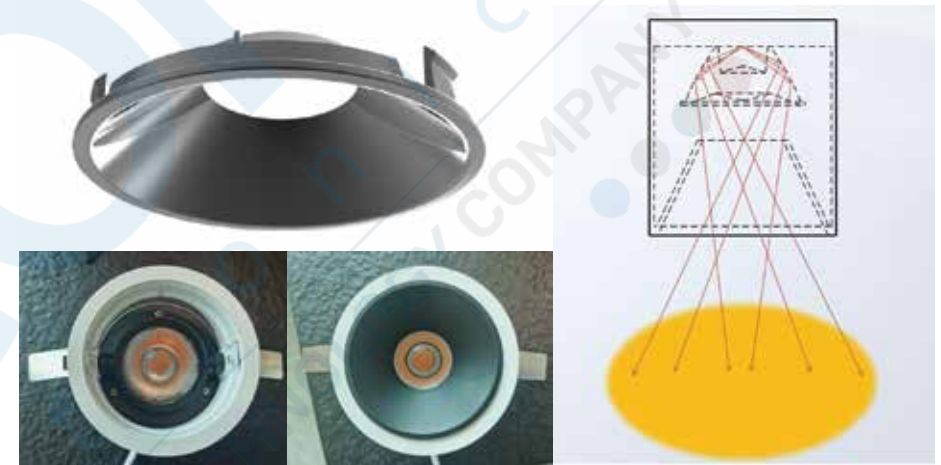

Types & Color	Size	Distance between light-hood & lens	Small hole Diameter	Adaptable lens	Adaptable filter	
Oblique: Matte Black/ Bright Black/ Bright Gold/ Bright Silver	D: 33.5mm H: 10.68mm	h: 5.2mm	/	Dark25/Gemini25/ Moony25/Peak25	Single asymmetric/ Double asymmetric/ Linear spot/ Matte filter	
	D: 50mm H: 9.65mm	h: 12mm	/	Dark30/Gemini30/ Moony30/Peak30		
	D: 50mm H: 17.89mm	h: 5.2mm	/	Dark35/Gemini35/ Moony35/Peak35		
	D: 68mm H: 23.45mm	h: 5mm	/	Dark35/Gemini35/ Moony35/Peak35		
	D: 68mm H: 25mm	h: 5.17mm	/	Dark45/Gemini45/ Moony45/Peak45		
	D: 70mm H: 28mm	h: 5.2mm	/	Dark50/Gemini50/ Moony50/Peak50		
	D: 100mm H: 36.3mm	h: 7mm	/	Dark55/Gemini55/ Moony55/Peak55		
	D: 100mm H: 37mm	h: 8mm	/	Dark62/Gemini62/ Moony62/Peak62		
	D: 145mm H: 50.9mm	h: 8mm	/	Dark68/Gemini68/ Moony68/Peak68		
	D: 145mm H: 52.07mm	h: 10mm	/	Dark75/Gemini75/ Moony75/Peak75		
	Small hole: Matte Black/ Bright Black/ Bright Gold/ Bright Silver	D: 68mm H: 20.77mm	h: 9mm	d: 23mm		Dark35/Gemini35/ Moony35/Peak35
		D: 68mm H: 17.77mm	h: 12.4mm	d: 29mm		Dark45/Gemini45/ Moony45/Peak45

LIGHT HOOD

Peak series lens & Flat hood

Kirin Optical Platform Peak series lens with flat hood Wall washing is clean, without delamination, and the light spot is uniform.



Dark series lens & Small hole hood

Kirin Optical Platform Dark series lens with small hole hood Uniform light spot, deeper anti-glare.

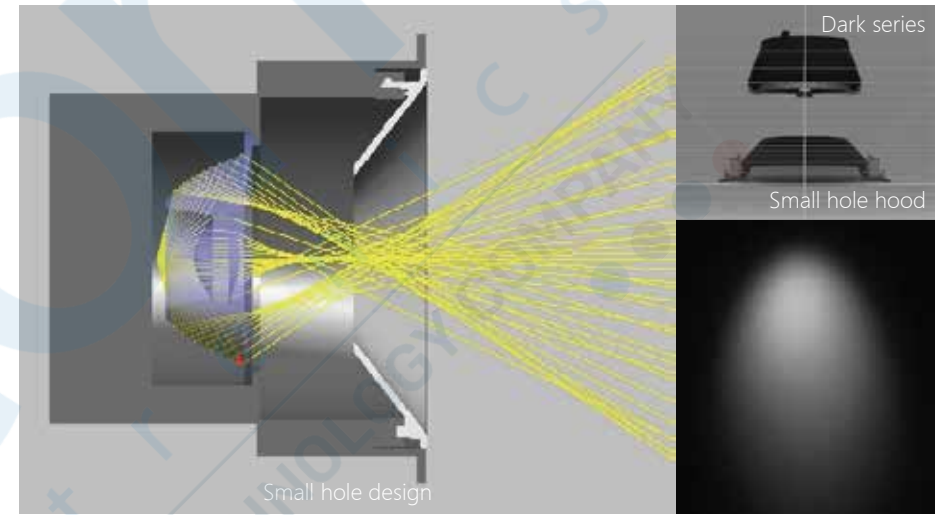

Flat hood matching information sheet



MN	1.07.23184	1.07.23141	1.07.23142	1.07.23190	1.07.23161	1.07.23217	1.07.23083
Flat Hood Diameter	33.5	50	50	50	68	68	68
Peak Diameter	PEAK 20@10	PEAK 25@13	PEAR 30@15	PEAK 35@16		PEAK 40@19	PEAK 45@21
15°				1.01.23222			1.01.23307(D6)
24°	1.01.23154	1.01.13050	1.01.13021	1.01.12962	1.01.23216		1.01.12657(D6) 1.01.23096(D9)
36°	1.01.23163	1.01.23143	1.01.23139	1.01.13016			1.01.23067(D6) 1.01.23137(D9)
50°				1.01.23212			1.01.23319(D6) 1.01.23319(D9)

Small hole hood matching information sheet



Hood Diameter	33.5	50	50	68	68	68	70	100	90	100	145
Hood MN	1.07.12752	1.07.12663	1.07.12745	1.07.02471	1.07.92058 (D6)	1.07.12764 (D9)	1.07.23079	1.07.12670	1.07.12813	1.07.12665	1.07.12731
Matching Dark Diameter	25	30	35	35	45	45	50	55	62	62	68

LIGHT HOOD

Dark/Moony & Oblique hood

Kirin Optical Platform Moony/Dark series lenses with oblique hole hood, The edge of the spot is cut off cleanly and the transition is even.

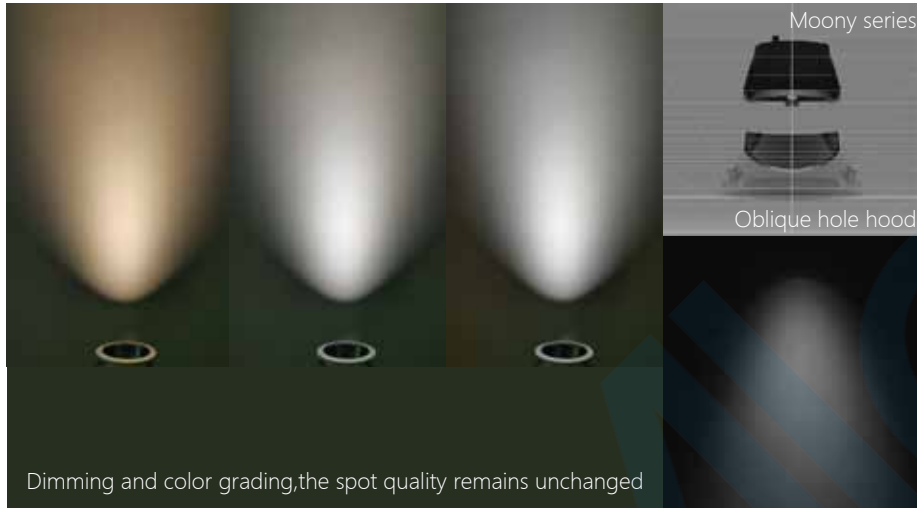

Oblique hole hood matching information sheet

Hood Diameter	50	68	68	70	100	100	145	145
Hood MN	1.07.92096	1.07.02440	1.07.02335	1.07.92097	1.07.92135	1.07.92104	1.07.92118	1.07.92102
Matching Dark/Moony diameter	35	35	45	50	55	62	68	75

Dark series lens & Wall washing hood solution

Kirin Optical Platform Dark series lenses with wall washing hood, The entire wall has uniform brightness and the skyline is clear.



Recommended wall washing hood solution

	35 Opening scheme	55 Opening scheme	75 Opening scheme	95 Opening scheme
Wall Washing Hood MN	1.07.23206 /1.07.23206	1.07.23295_A /1.07.23295_B	1.07.23130	1.01.23310
Recommended optics	Dark D25-15° 1.01.92131	Dark D35-15° 1.01.91997	Dark D45-15° 1.01.91887	Dark D50-15° 1.01.92006

Principle

Photon Lens designed by one refracting surface and several fully reflecting surfaces, can control the light distribution well by lower lens height.

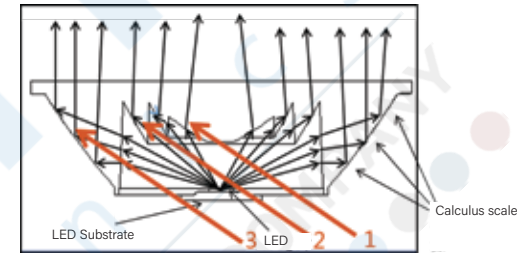

Why can make the light distribution well by lower lens height?

Area 1 is refracting surface, control the light from the middle of the LED, to control the small beam angle; Area 2 are fully reflecting surfaces, little far away from the COB, control some long lights to be small beam angle; Area 3 are periphery fully reflecting surfaces, control the outermost lights also the best lights, can make smaller beam angle and make a clear edge light spot

To sum up, the lens of the Photon series divides the light of the light source into several parts, and then optimizes each part. In the case of light spot cut-off, the central light intensity is high.

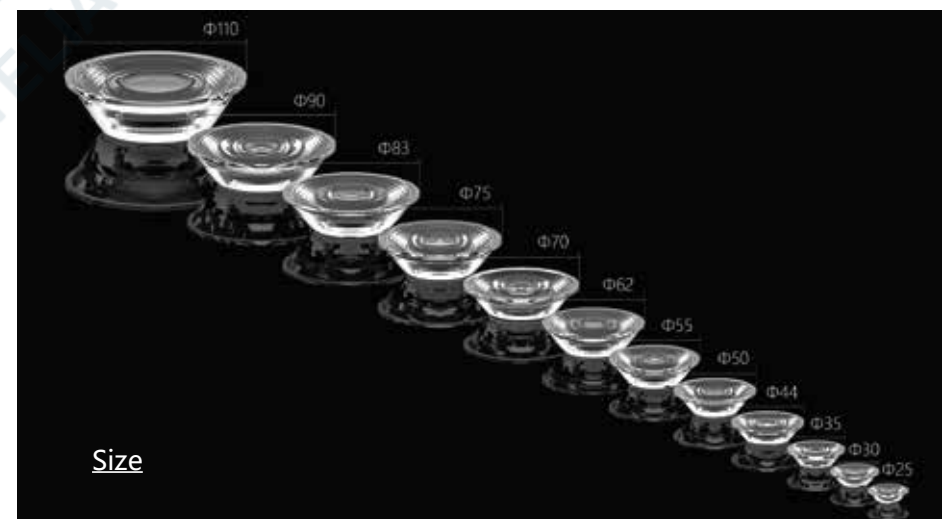
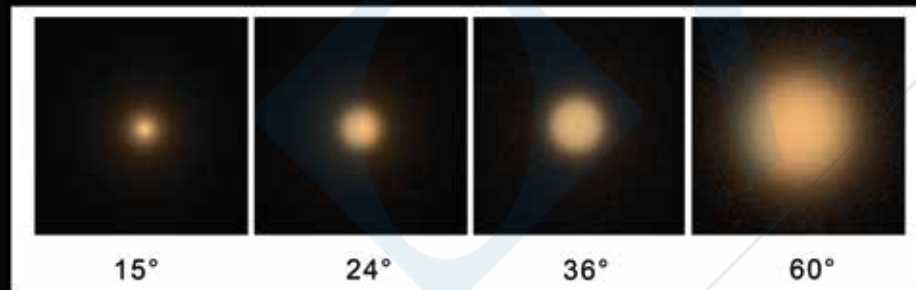



PHOTON 25@07

φ: 25mm H: 6.7mm
Material: PC
FWHM: 15°/24°/36°/60°
Wall wash: 15°/24°/36°/60°
Efficiency: 85%



PHOTON 30@08

φ: 30mm H: 8mm
Material: PC
FWHM: 15°/24°/36°/60°
Efficiency: 85%



PHOTON 35@10

φ: 35mm
Material: PC
FWHM: 15°/24°/36°/60°
Wall wash: 15°/24°/36°/60°
Color mixing: 15°/24°/36°/60°
Efficiency: 85%



PHOTON 44@11

φ: 44mm H: 11.3mm
Material: PC
FWHM: 15°/24°/36°/60°
Wall wash: 15°/24°/36°/60°
Color mixing: 15°/24°/36°/60°
Efficiency: 85%

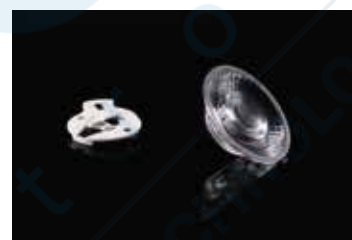

PHOTON 50@14

φ: 50mm H: 14mm
Material: PC
FWHM: 15°/24°/36°/60°
Color mixing: 15°/24°/36°/60°
Efficiency: 85%



PHOTON 55@15

φ: 55mm
Material: PC
FWHM: 15°/24°/36°/60°
Efficiency: 85%



PHOTON 62@18

φ : 62mm H: 17.5mm
Material: PC
FWHM: 15°/24°/36°/60°
Efficiency: 85%



PHOTON 83@22

φ : 83mm H: 22mm
Material: PC
FWHM: 15°/24°/36°/60°
Efficiency: 85%



PHOTON 70@19

φ : 70mm H: 18.5mm
Material: PC
FWHM: 15°/24°/36°/60°
Efficiency: 85%

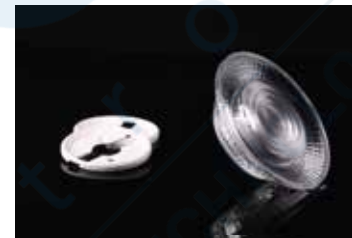

PHOTON 90@22

φ : 90mm H: 23.2mm
Material: PC
FWHM: 15°/24°/36°/60°
Efficiency: 85%

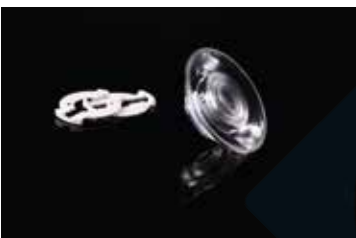

PHOTON 75@21

φ : 75mm H: 21.5mm
Material: PC
FWHM: 15°/24°/36°/60°
Efficiency: 85%



PHOTON 110@32

φ : 110mm H: 32mm
Material: PC
FWHM: 15°/24°/36°/60°
Efficiency: 85%



Facula shape



Commercial lighting application





KA 35@16

φ: 35mm H: 16mm
 Material: PC/PMMA
 FWHM: 10°/15°/24°/36°/50°
 Efficiency: 90%



KA 43@19

φ: 43mm H: 19mm
 Material: PC/PMMA
 FWHM: 10°/15°/24°/36°/60°
 Efficiency: 90%



KA 40@20

φ: 40mm H: 20mm
 Material: PC/PMMA
 FWHM: 15°/24°/36°/60°
 Efficiency: 90%



KA 45@21

φ: 45mm H: 21mm
 Material: PMMA
 FWHM: 15°/24°/36°/60°
 Efficiency: 90%



KA 50@25

φ: 50mm H: 25mm
 Material: PMMA
 FWHM: 12°/15°/24°/36°/45°/60°
 Efficiency: 90%



KA 55@24

φ: 55mm H: 24mm
 Material: PMMA
 FWHM: 15°/24°/36°/60°
 Efficiency: 90%



KA 62@31

φ: 62mm H: 31mm
 Material: PMMA
 FWHM: 15°/24°/36°/45°/60°
 Efficiency: 90%



KA 66@36

φ: 66mm H: 36mm
 Material: PMMA
 FWHM: 15°/24°/36°/60°
 Efficiency: 90%



KA 69@30

φ: 69mm H: 30mm
 Material: PMMA
 FWHM: 15°/24°/36°/60°
 Efficiency: 90%



KA 72@33

φ: 72mm H: 33mm
 Material: PMMA
 FWHM: 12°/15°/20°/24°/36°/60°
 Efficiency: 90%



KA 75@31

φ: 75mm H: 31mm
 Material: PMMA
 FWHM: 10°/15°/24°/36°/60°
 Efficiency: 92%



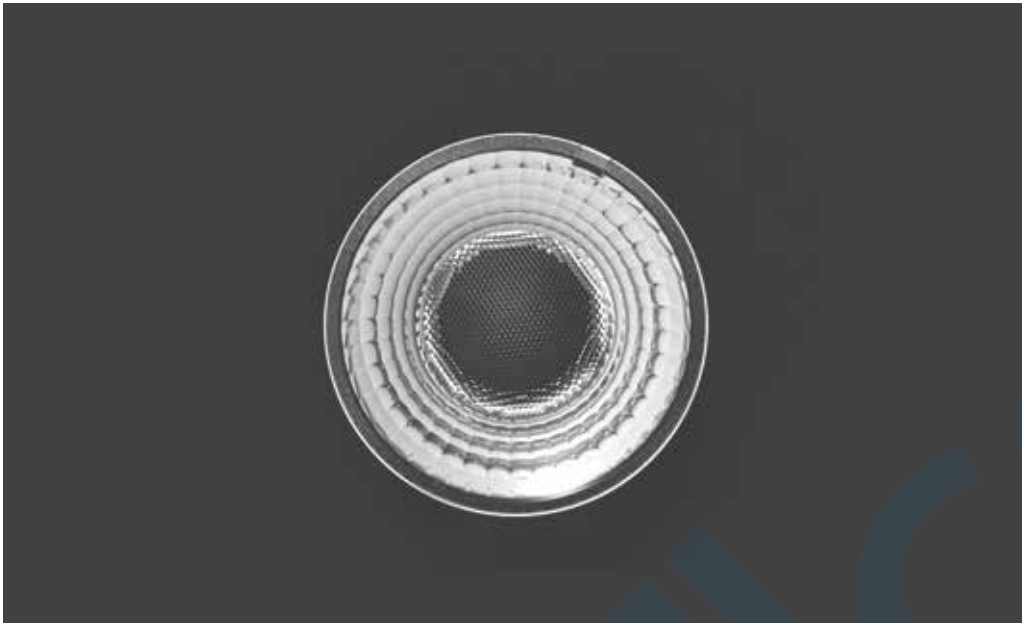

Product Characteristics

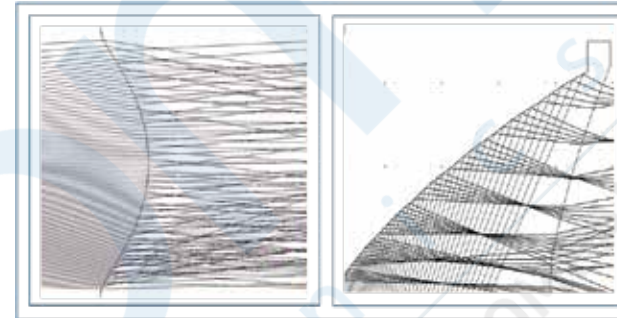

Using calculus total reflection combined with local directional differential technology, while the color temperature and brightness of the light source change, the angle and color of the light spot are not affected.

Using the principle of calculus lens, the reflected light is differentiated to effectively mix light. Add a surface differential structure to the incident and exit convex surfaces, so that the transmitted light is evenly distributed, and the color is uniform.

Principle of Design

The reflecting surface of the lens uses the principle of differential and integration. The light emitted by the light source is differentiated by a large number of scales, and the light source is divided into several sub-light sources (differential). Each sub-light source is presented separately on the illumination light field, and by rearranging and overlapping the centers, rotating and superimposing (integration), the light of different color temperatures is cross-distributed to achieve a mixed light effect. Differential redistribution of the light source not only makes the light more finely distributed and achieves a good light mixing effect, but also the brightness of the light emitting surface is uniform and even. The area reduces the glare of the lens.

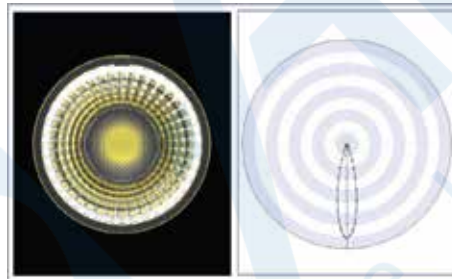

The transmission surface of the lens is arranged in a microstructure and a function array to control the intermediate light reasonably, and then the light from the light source is differentiated and superimposed in an orderly manner, thereby solving the problem of uneven mixing of light transmitted through the lens.

Chameleon Series, Size: 55@21, 24° Lens Spot



CHAMELEON



CHAMELEON 35@16

φ: 35mm H: 16mm
Material: PC/PMMA
FWHM: 24°/36°/60°
Efficiency: 90%



CHAMELEON 43@19

φ: 43mm H: 19mm
Material: PC/PMMA
FWHM: 24°/36°/60°
Efficiency: 90%



CHAMELEON 55@24

φ: 55mm H: 24mm
Material: PMMA
FWHM: 24°/36°/60°
Efficiency: 90%



CHAMELEON 62@31

φ: 62mm H: 31mm
Material: PMMA
FWHM: 24°/36°/60°
Efficiency: 90%



CHAMELEON 44@20

φ: 44mm H: 20mm
Material: PC
FWHM: 24°/36°/60°
Efficiency: 90%



CHAMELEON 55@21

φ: 55mm H: 21mm
Material: PMMA
FWHM: 24°/36°/60°
Efficiency: 90%



CHAMELEON 72@33

φ: 72mm H: 33mm
Material: PMMA
FWHM: 24°/36°/60°
Efficiency: 90%



CHAMELEON 75@31

φ: 75mm H: 31mm
Material: PMMA
FWHM: 24°/36°/60°
Efficiency: 90%

Introduction

The Max shielding angle of the LED lamp is 46°, can avoid the glare effectively. The most accepted shielding angle of the human visual area always more than 30°, the other light in this area will occur the glare. So when the shielding angle of the LED lamp more than 30°, will control the light out the area to decrease glare.

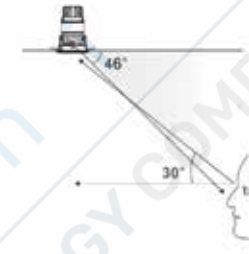

The polarized light wash wall lamp should have the drift angle, normally have the problem of stratified facula because of the antiglare visor interfered the facula. Herculux Black Hole family special designed for the hotel, considered the effect of the front ring of the antiglare visor before designing, can distribute the light effectively, even when the customer replacing the front ring, the facula will transit uniformly.

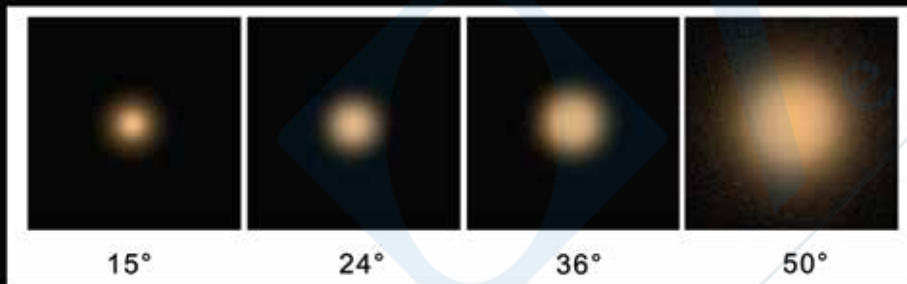
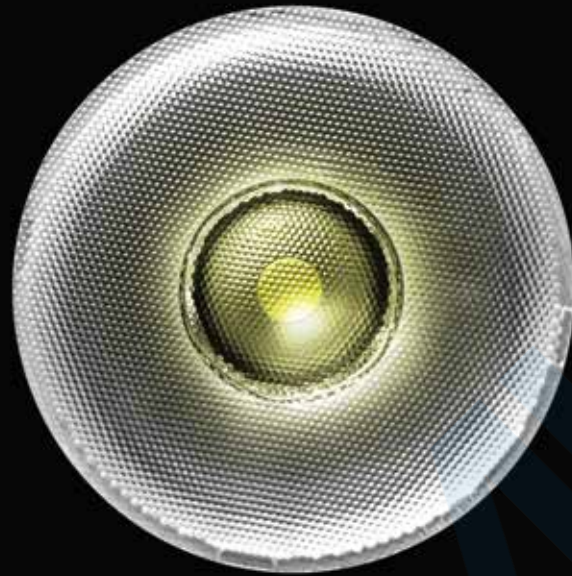
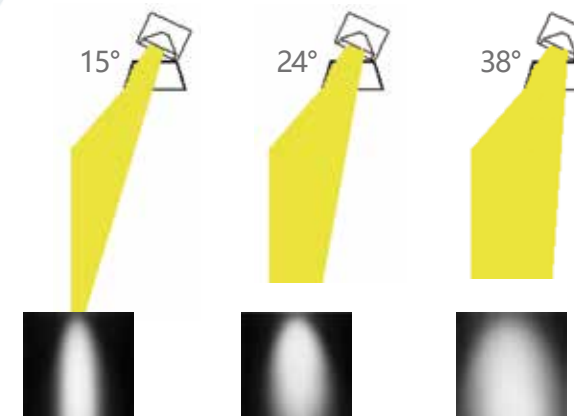

BLACK HOLE

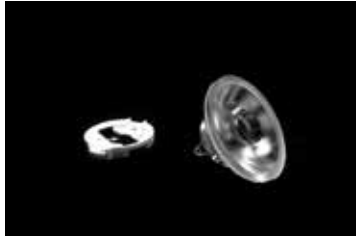

BLACK HOLE 28@14

φ: 28mm H: 14mm
Material: PC
FWHM: 15°/24°/36°/50°
Efficiency: 85%

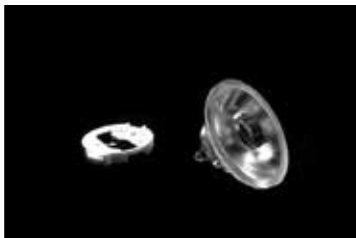

BLACK HOLE 30@15

φ: 30mm H: 15mm
Material: PC
FWHM: 15°/24°/36°/50°
Efficiency: 85%

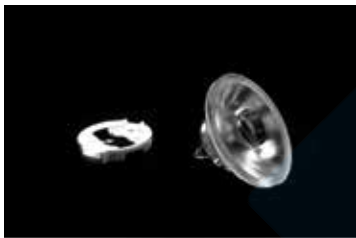

BLACK HOLE 35@18

φ: 35mm H: 18mm
Material: PC
FWHM: 15°/24°/36°/50°
Efficiency: 85%

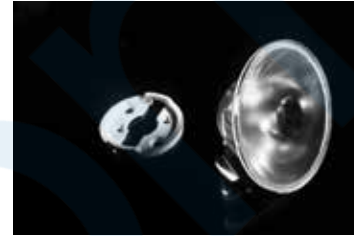

BLACK HOLE 45@24

φ: 45mm H: 24mm
Material: PC
FWHM: 7°/10°/24°/34°/50°
Efficiency: 85%



BLACK HOLE 50@24

φ: 50mm H: 24mm
Material: PC
FWHM: 15°/24°/36°/50°
Efficiency: 85%



BLACK HOLE 62@24

φ: 62mm H: 24mm
Material: PC
FWHM: 15°/24°/36°/50°
Efficiency: 85%

High efficiency (90%)

Zooming is achieved by properly distributing the ratio of reflected and refracted light during zooming, rather than actively losing light to achieve it, thereby achieving high efficiency.

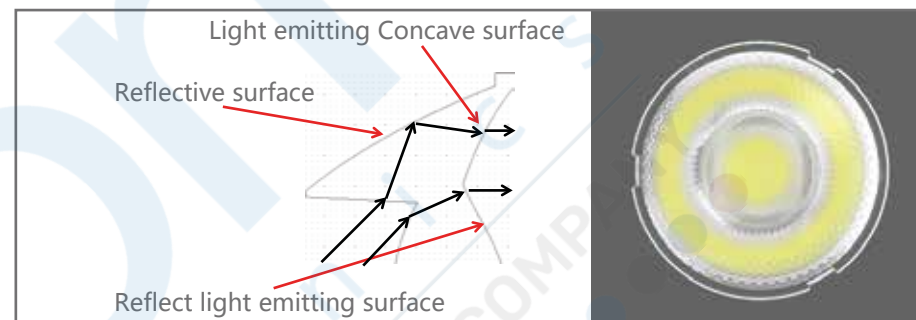

Short stroke

Beam angle of the intermediate refracted light is designed larger in a shorter stroke so that the Min and Max beam angles stroke difference are in a shorter range.



Nice cutoff and fulfilled spot center (strong zoom capability):

The spot cutoff is generated by the intermediate refracted light; considering the overall zooming effect, the cutoff is made moderate by adding an appropriate compound eye to optimize the spot edge on the refracting light exit surface.

Innovatively adding a two-dimensional uniform light microstructure to the surface of the lens, so that the light intensity is softened, the central light intensity can be guaranteed; Especially for the wide beam angle central spot, it has a certain compensation effect, making the center of the wide beam angle spot full.

Better anti-glare effect

In the process of zooming, the main light of the narrow beam angle is emitted along the optical axis direction, while the main light is deflected away from the hood at a wide beam angle, only very little light reaches the hood regardless of the beam angles. So the new lens can be matched with a deeper anti-glare cover to achieve a better anti-glare effect comparing to conventional KA.

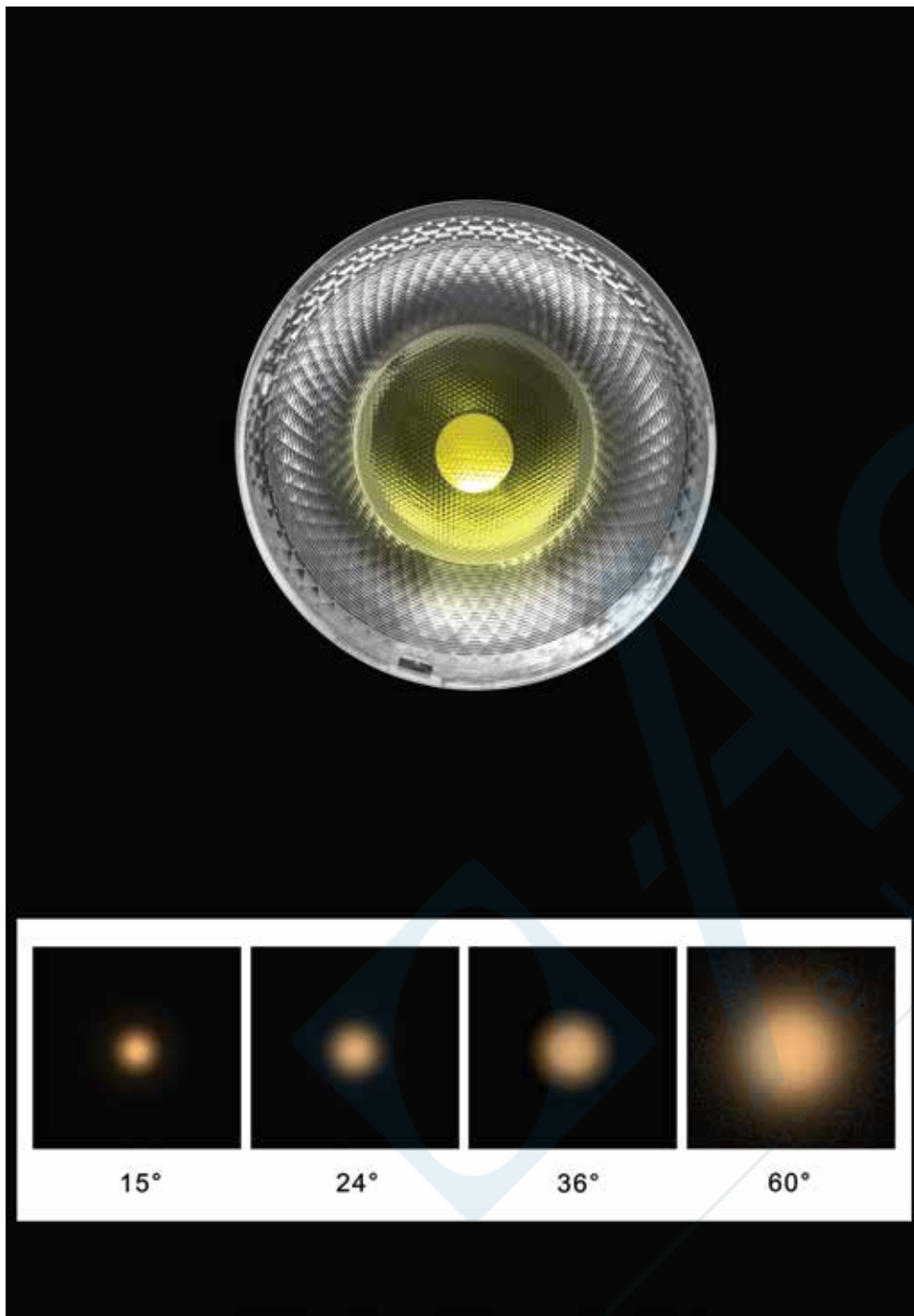
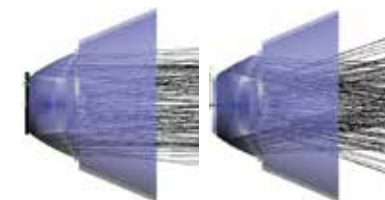



INFINITY 35@15-15_36

φ: 35mm H: 15mm
Material: PMMA
FWHM: 15°~36°
Efficiency: 90%~92%



INFINITY 35@14-35_60

φ: 35mm H: 14mm
Material: PMMA
FWHM: 35°~60°
Efficiency: 90%~92%



INFINITY 55@25-15_36

φ: 55mm H: 25mm
Material: PMMA
FWHM: 15°~36°
Efficiency: 90%~92%



INFINITY 55@23-35_60

φ: 55mm H: 23mm
Material: PMMA
FWHM: 35°~60°
Efficiency: 90%~92%



INFINITY 45@20-15_36

φ: 45mm H: 20mm
Material: PMMA
FWHM: 15°~36°
Efficiency: 90%~92%



INFINITY 45@18-35_60

φ: 45mm H: 18mm
Material: PMMA
FWHM: 35°~60°
Efficiency: 90%~92%



INFINITY 62@28-15_36

φ: 62mm H: 28mm
Material: PMMA
FWHM: 15°~36°
Efficiency: 90%~92%



INFINITY 62@26-35_60

φ: 62mm H: 26mm
Material: PMMA
FWHM: 35°~60°
Efficiency: 90%~92%

INFINITY



INFINITY 72@33-15_36

φ: 72mm H: 33mm
Material: PMMA
FWHM: 15°~36°
Efficiency: 90%~92%



INFINITY 72@29-35_60

φ: 72mm H: 29mm
Material: PMMA
FWHM: 35°~60°
Efficiency: 90%~92%



INFINITY 75@34-15_36

φ: 75mm H: 34mm
Material: PMMA
FWHM: 15°~36°
Efficiency: 90%~92%



INFINITY 75@30-36_60

φ: 75mm H: 30mm
Material: PMMA
FWHM: 35°~60°
Efficiency: 90%~92%



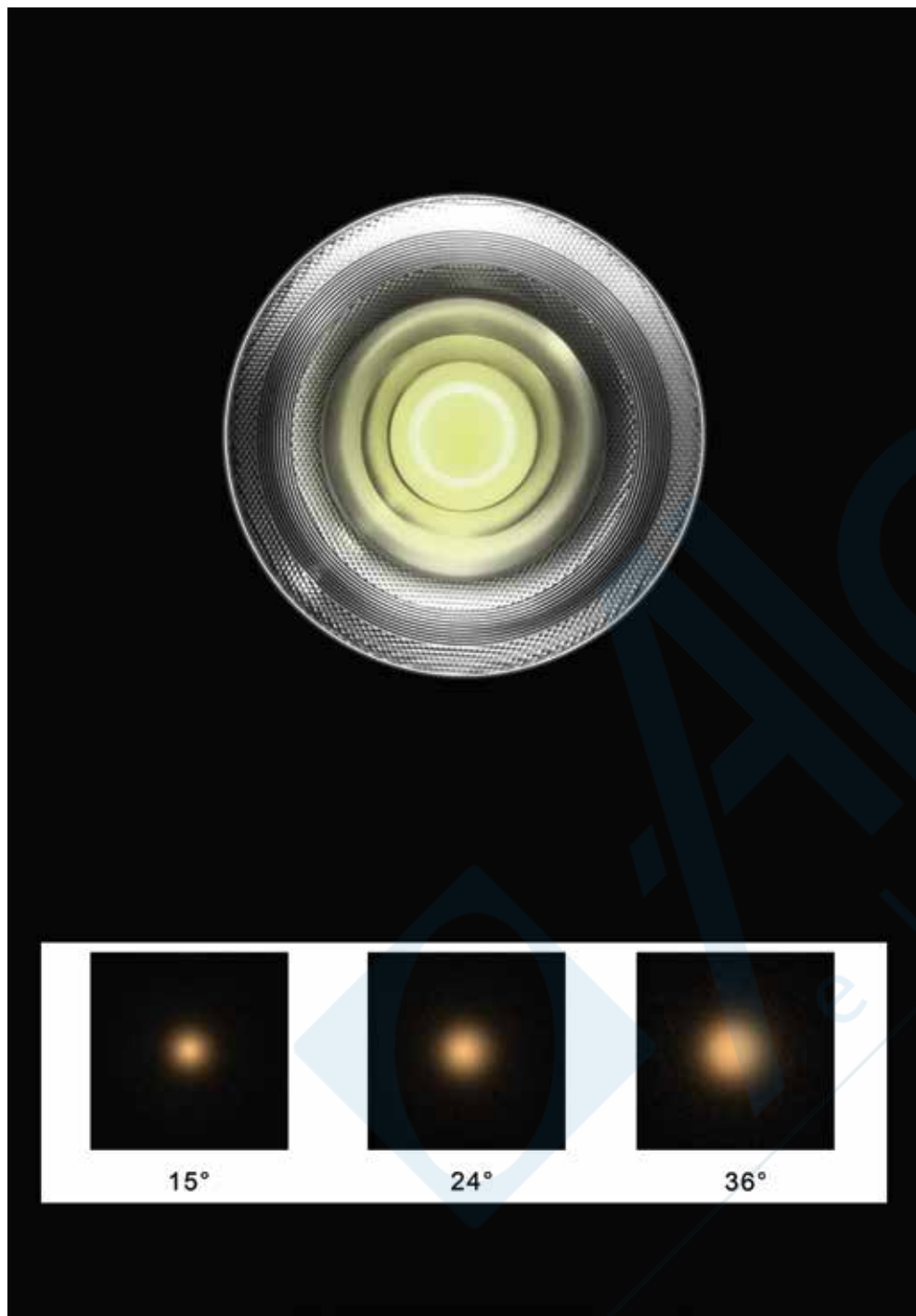

Introduction

Different with the traditional convex lens, the focus family can keep the same efficiency when zooming. By the special optical designing, each reflection surfaces have the same uniform energy to achieve good uniformity without the dark in the middle.

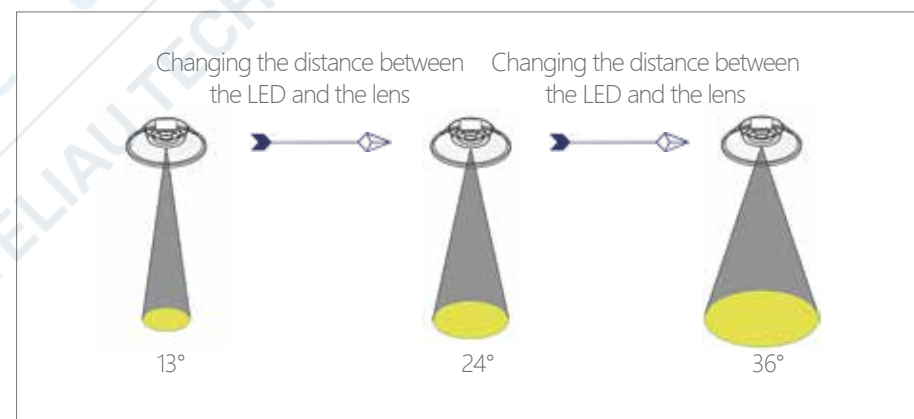
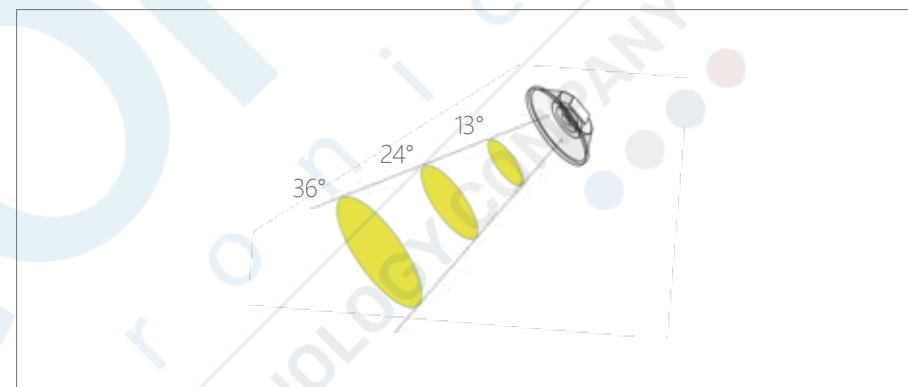

Product characteristics

Fresnel lens has unique optical properties, which can change the optical angle and the size of the spot by changing the distance between light source and lens.

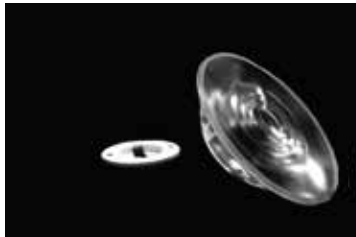

FOCUS 35@10

φ : 35mm H: 10mm
Material: PC
FWHM: 13°~36°
Efficiency: 85%

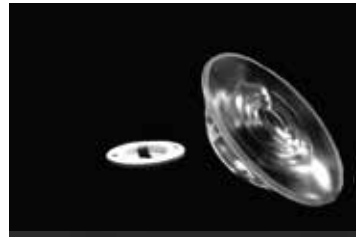

FOCUS 44@13

φ : 44mm H: 13mm
Material: PC
FWHM: 13°~36°
Efficiency: 85%

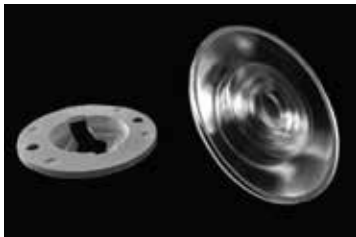

FOCUS 50@14

φ : 50mm H: 14mm
Material: PC
FWHM: 13°~38°
Efficiency: 85%



FOCUS 62@17

φ : 62mm H: 17mm
Material: PC
FWHM: 13°~36°
Efficiency: 85%



FOCUS 72@20

φ : 72mm H: 20mm
Material: PC
FWHM: 13°~36°
Efficiency: 85%



FOCUS 75@19

φ : 75mm H: 19mm
Material: PC
FWHM: 13°~38°
Efficiency: 85%



FOCUS 90@24

φ : 90mm H: 24mm
Material: PC
FWHM: 13°~38°
Efficiency: 85%

POLAROID

Lens front view

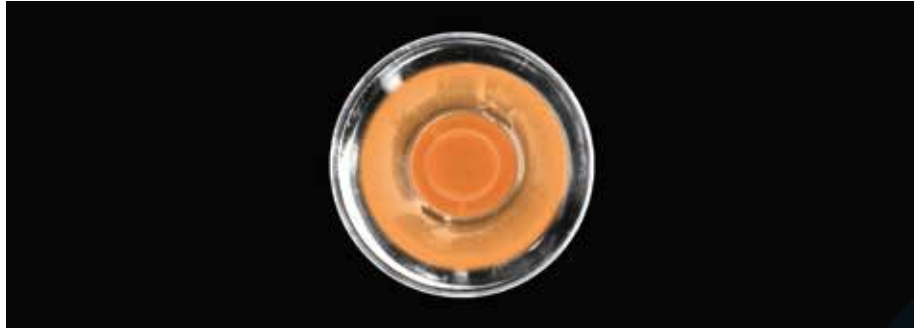

Facula shape

Polaroid Filter A:
25°

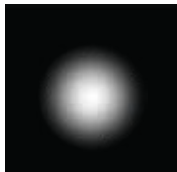

Polaroid Filter B:
36°

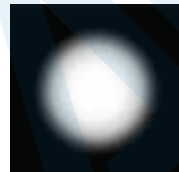

Polaroid Filter C:
25°×25°

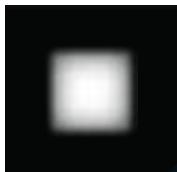

Polaroid Filter D:
36°×36°



Polaroid Filter E:
25°×36°



Polaroid Filter F:
10°×25°



Polaroid Filter G:
10°×36°

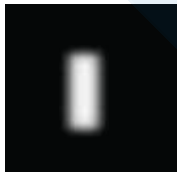

Polaroid Filter H:
4°×36°



Introduction

Polaroid means using the normally narrow beam angle circle optics to achieve different beam angle, different shape of the facula. Main application is the partial lighting in the art exhibition, not only can achieve different facula requirements, but also can decrease the cost effectively.

Principle

Redistributing the collimating light by each tiny structures to achieve different beam angle and different shape optics, then mixed to achieve different target facula.

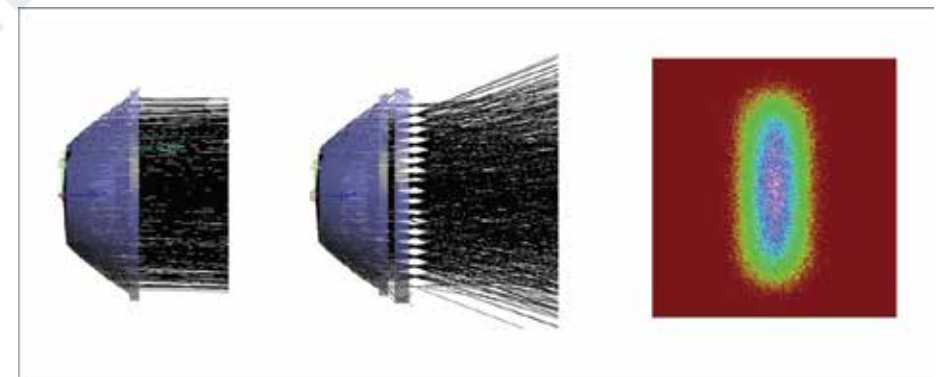
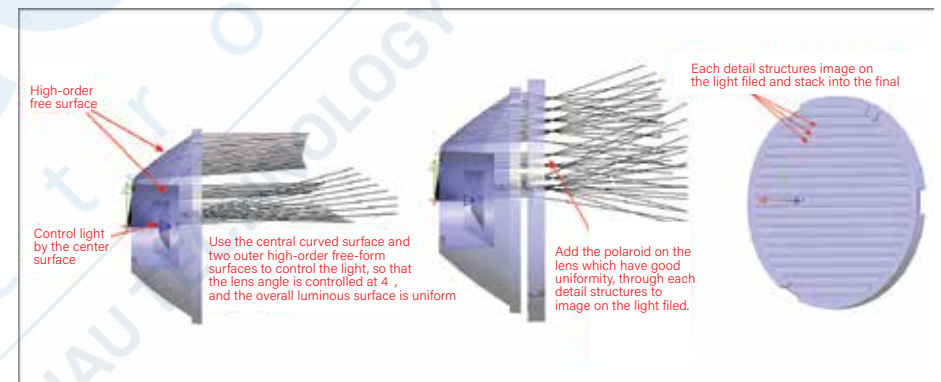

POLAROID



POLAROID 30@11

φ: 30mm H: 11mm
Material: PC
FWHM: 6°
Efficiency: 90%



POLAROID 35@21

φ: 35mm H: 21mm
Material: PC
FWHM: 7°
Efficiency: 90%

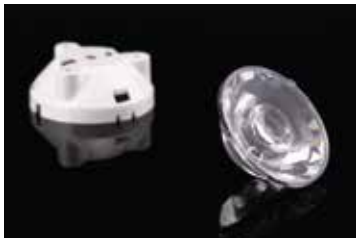

POLAROID 40@15

φ: 40mm H: 15mm
Material: PC
FWHM: 4° / 6.9°
Efficiency: 90%



POLAROID 50@18

φ: 50mm H: 18mm
Material: PC
FWHM: 3°
Efficiency: 90%

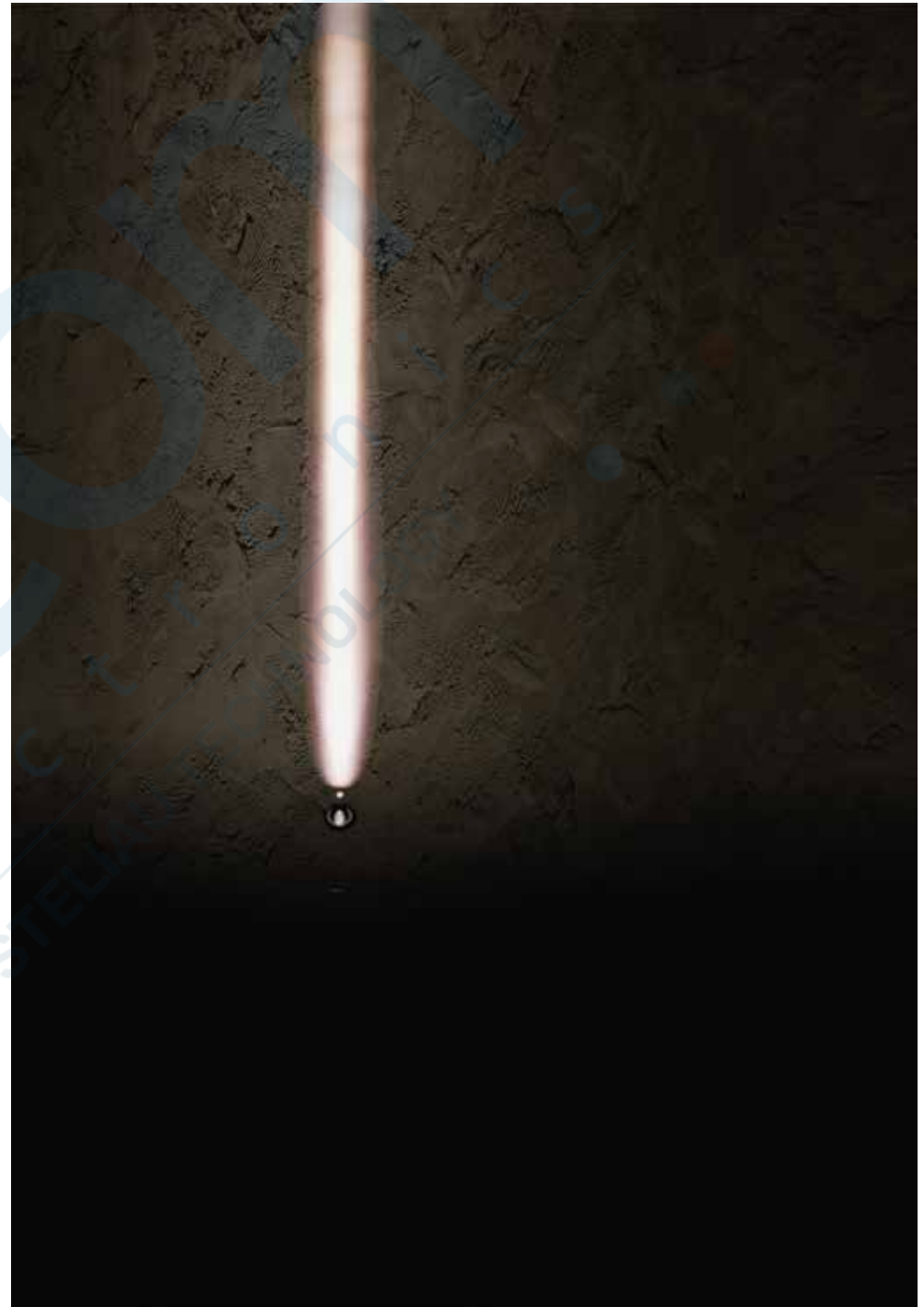

Design Principle

Triple-Reflection technology is a great innovation based on Calculus technology, greatly reduced the lens height compare with the original calculus lens, let the light reflect three times inside the lens, make sure get good light distribution with lower height lens.

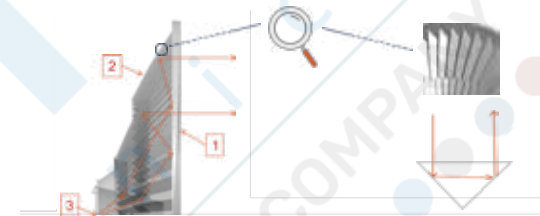

Graphic 1 is a fully reflecting surface and a optical emitting surface, light from graphic 3(LED) fully reflected to graphic 2(included angle) by the surface 1, then totally reflect two times in the included angle, at last all lights emit out from surface 1 by total three times reflection.

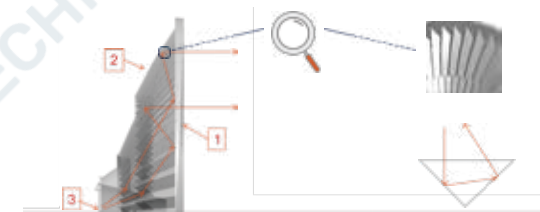

The reflect surfaces of included angle 2 are all fully reflecting surface, control the lens angle by adjust the surface shape. Ultrathin thickness 8mm, thinner than thinner, save more space for designer. Application: MR16/GU10/Downlight/Par20.

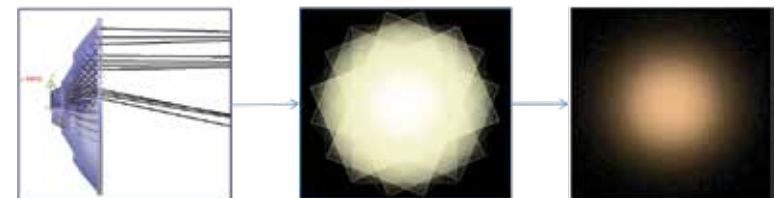

SUNFLOWER: HK-45@08-XX-7070-20-1g-1

φ: 45mm H: 8mm Material: PC Efficiency: 88% FWHM: 15°/24°/36°/60°

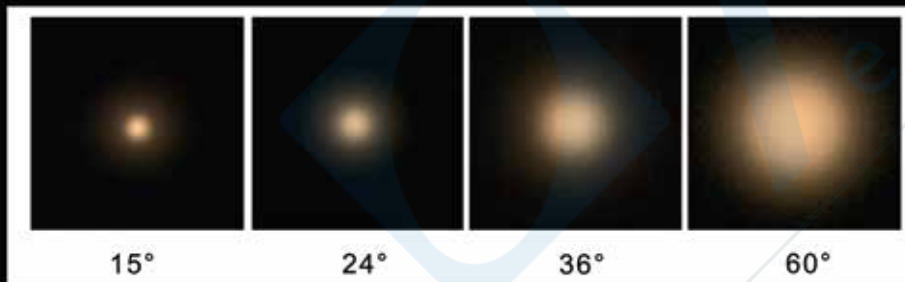

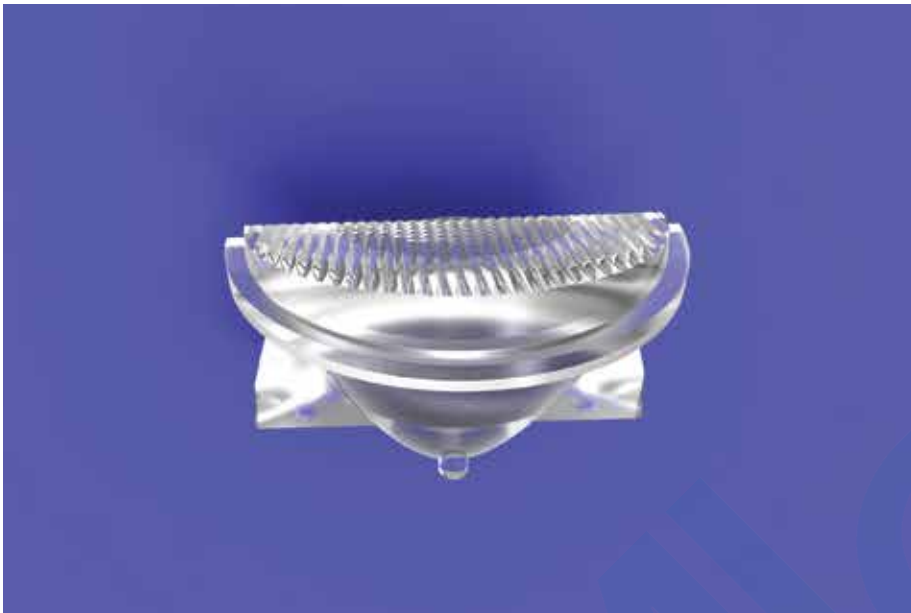

Structure design

The structure of the lens is matched with the design method of the lens, and the holder design has its own anti-glare function. (Due to the inconsistency of different lamps, HercuLux can provide design reference for the holder)

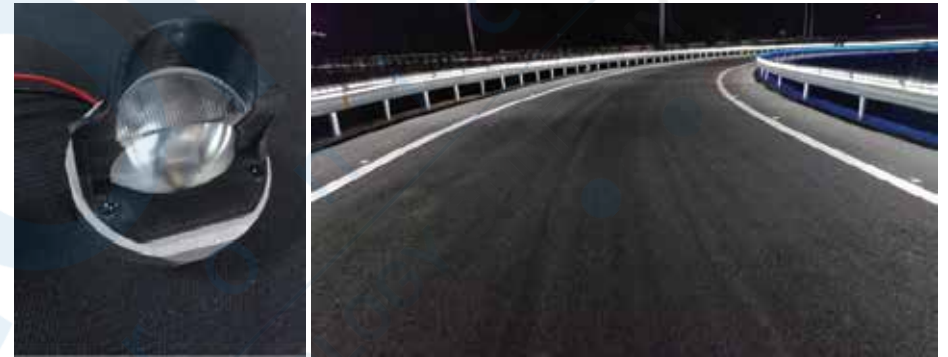

Product characteristics

High wall washing height, uniform light spot, high efficiency, applicable to low-pole lighting such as indoor wall washing and outdoor guardrail lights.

Light distribution

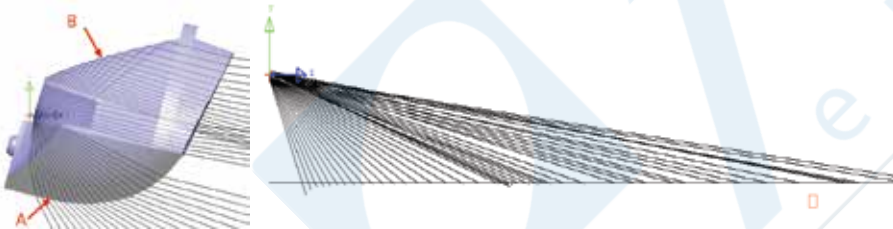

Using a combined light distribution, the optics at the top and bottom of the wall can be separated. The optical part of the lens is separated into part A (transmission type) and part B (total reflection type). The two parts are combined with light distribution to achieve wall washing lighting. The combination of the transmissive surface and the reflective surface makes the wall wash height high, close to the wall, and wide horizontal distance.



WATERFALL 35@23

φ: 35mm H: 23mm
Material: PMMA
Efficiency: 80%



WATERFALL 47@38

φ: 47mm H: 38mm
Material: PMMA
Efficiency: 80%

TRANSFORMERS



At the same time, through four inserts, the product can also freely adjust the circular spot to the following types of light spots.

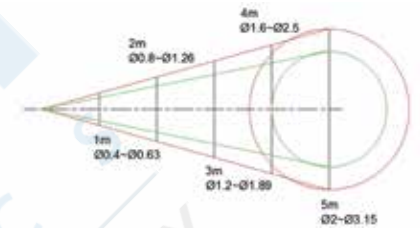

Instructions

Transformers, its initial form is as follows:



At this moment, turn left and right respectively 1, 2, Get the following pattern:



Pulling the part pointed by arrow 1 can change the sharpness of the spot boundary; Pulling the part pointed by arrow 2 changes the spot size. At the same time plug four inserts; Spin can change the spot shape arbitrarily, as the following example shows:

Insert the initial state as the right, A circular spot.



Structure diagram

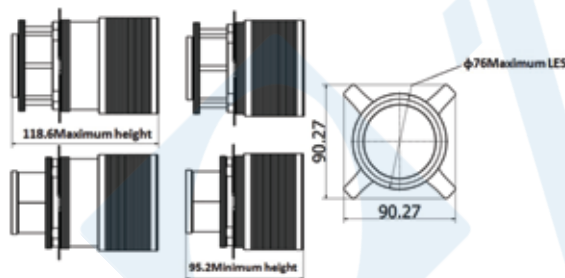

Introduction

This product consists of triple lens plus special structure. By moving the front and center lenses, the product can be made into circular patches of different sizes with clear or blurred borders.

TRANSFORMERS

Changing the position of the insert, the circular spot will change to a rectangular spot as shown below.



Change the position of the insert, as shown below, the circular spot will become a parallelogram spot.



Change the insert position, as shown below, the circular spot will become a trapezoidal spot.



Cooling installation size



When customers create cooling base, the remaining size can be customized, in addition to the size marked on the map for a fixed size. Application: Museum lighting, Art exhibition lighting or lighting used in special application.

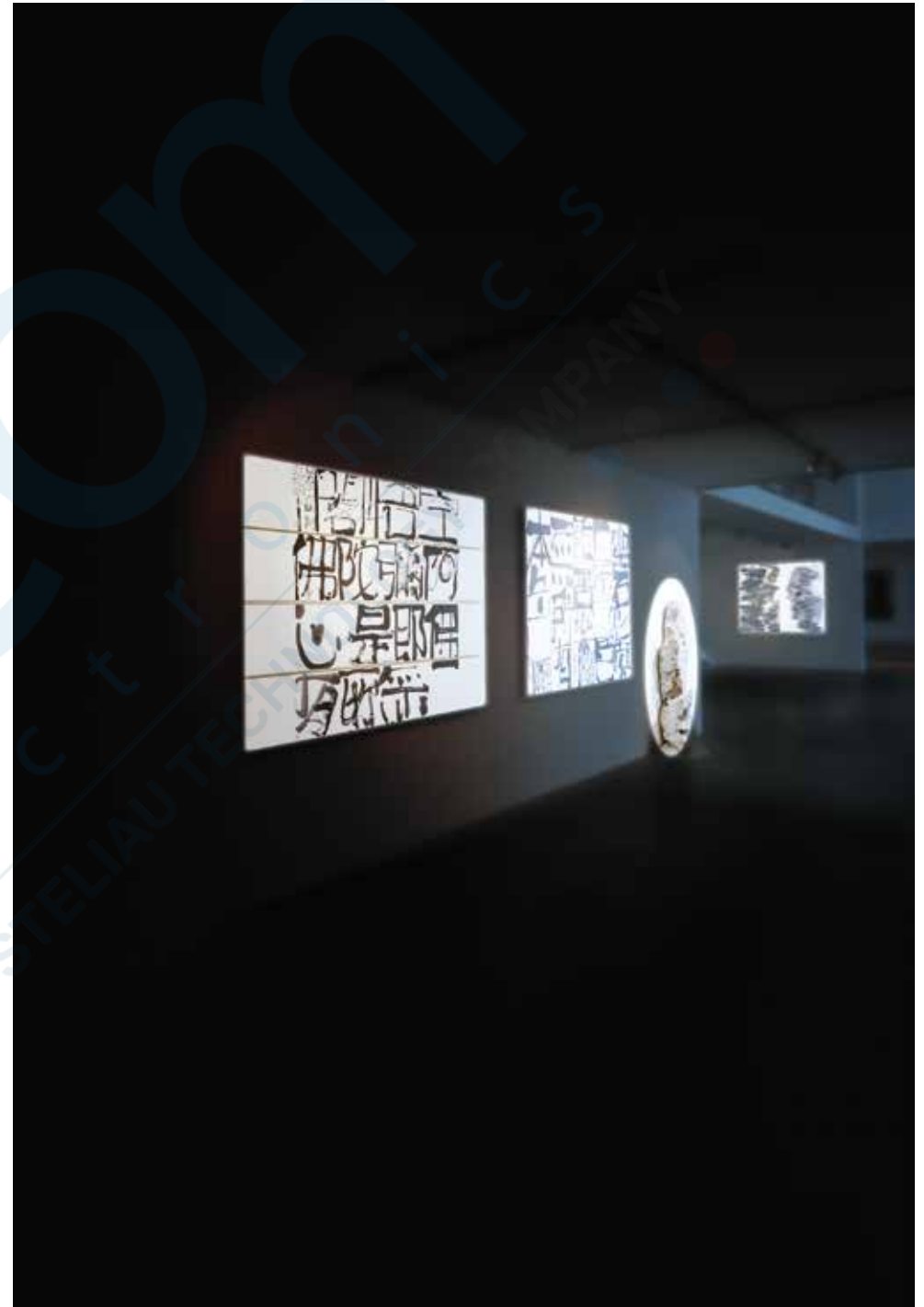

Principle

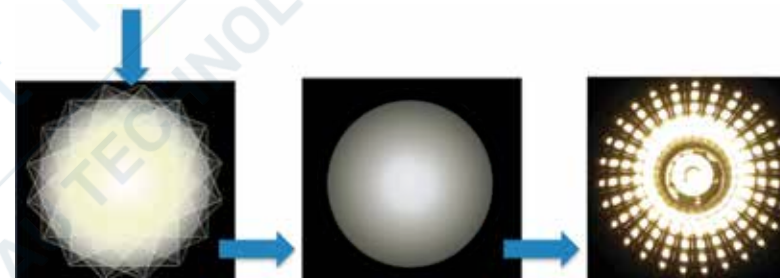
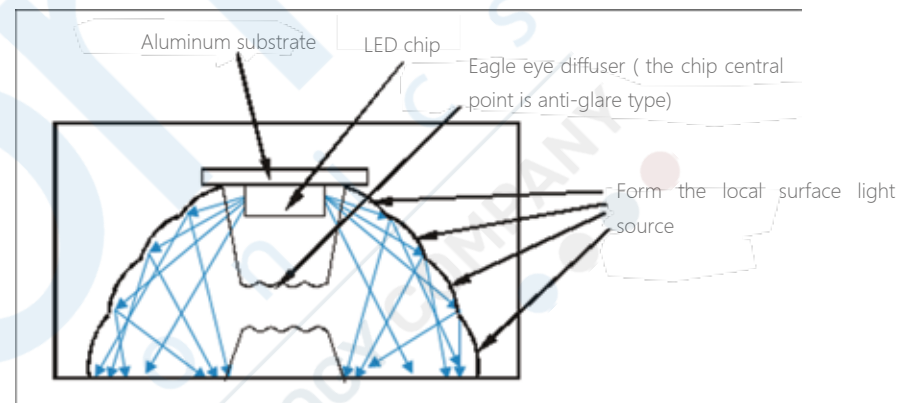

Make segmentation differential process for the wave surface of several scale light sources. In this way, the light source will be cut into several sub-light sources. (differential calculus for light source);

Each sub-light source forms sub-facula on the light field. The centers coincide with each other, rotate and overlay (differential calculus of light field) and form a lighting field with uniform color;

The light received by each scale would be consistent or with uniform change. In this way, the glaring surface of lens would have the same brightness and prevent dazzling.



DIAMOND



DIAMOND 35@12.4

φ: 35mm H: 12.4mm
Material: PMMA
FWHM: 24°/38°
Efficiency: 92%



DIAMOND 35@17

φ: 35mm H: 17.2mm
Material: PMMA
FWHM: 15°/24°/38°/60°
Efficiency: 92%



DIAMOND 43@22.8

φ: 43mm H: 22.8mm
Material: PMMA
FWHM: 15°/24°/36°/60°/90°/120°
Efficiency: 92%

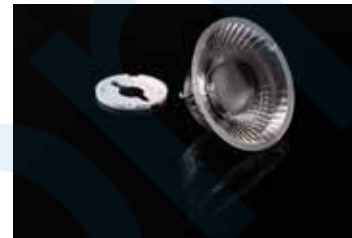

DIAMOND 44@18

φ: 44mm H: 18mm
Material: PMMA
FWHM: 24°/38°
Efficiency: 92%



DIAMOND 44@20

φ: 44mm H: 20mm
Material: PC
FWHM: 15°/24°/36°/60°
Efficiency: 90%



DIAMOND 46@24

φ: 46mm H: 24mm
Material: PMMA
FWHM: 10°
Efficiency: 92%

DIAMOND



DIAMOND 52@25

φ: 52mm H: 25mm
Material: PMMA
FWHM: 15°/24°/36°
Efficiency: 92%



DIAMOND 55@21

φ: 55mm H: 21mm
Material: PMMA
FWHM: 15°/24°/36°/60°
Efficiency: 90%



DIAMOND 62@22

φ: 62mm H: 22mm
Material: PMMA
FWHM: 30°/38°/60°/90°
Efficiency: 92%



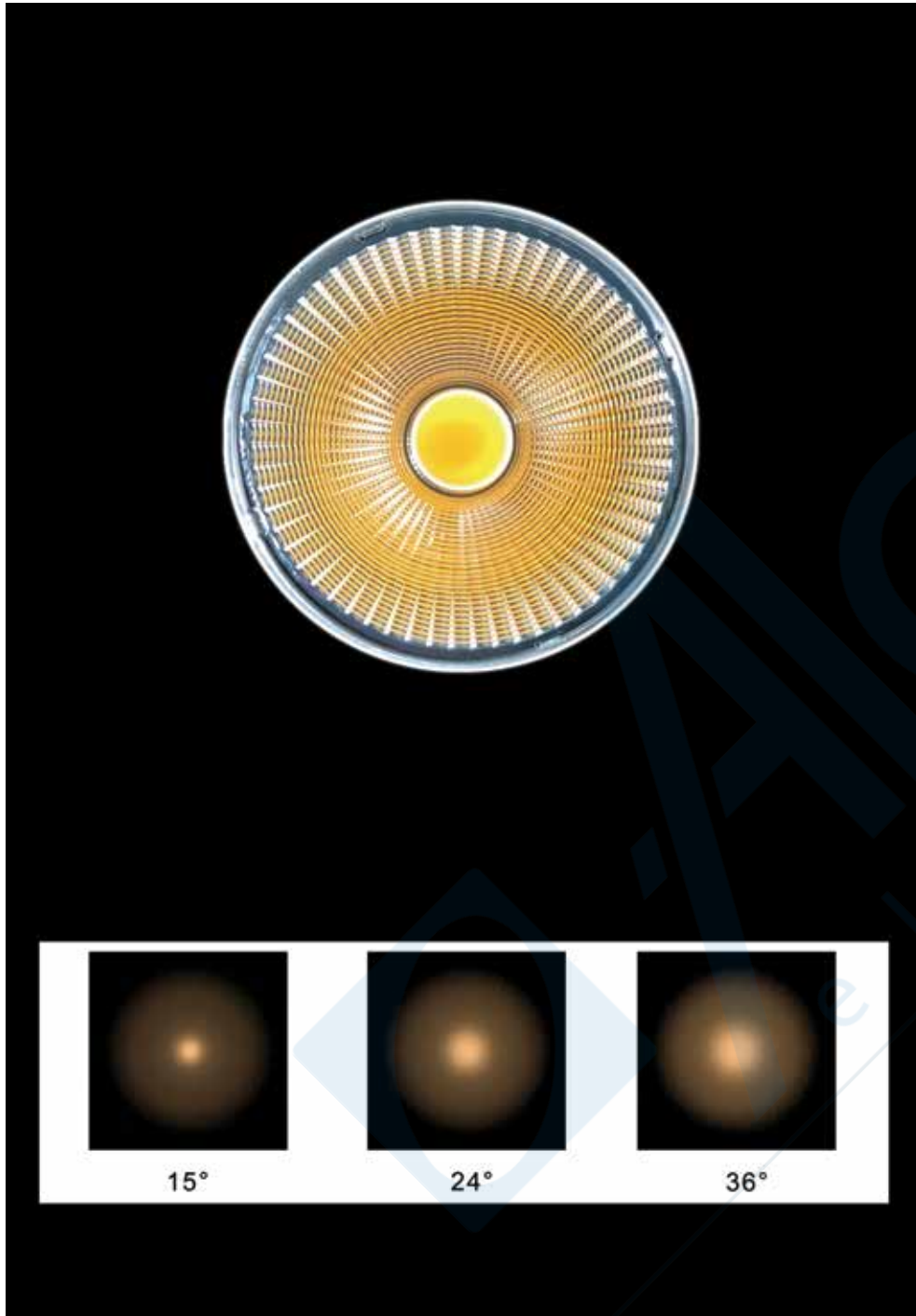

Features

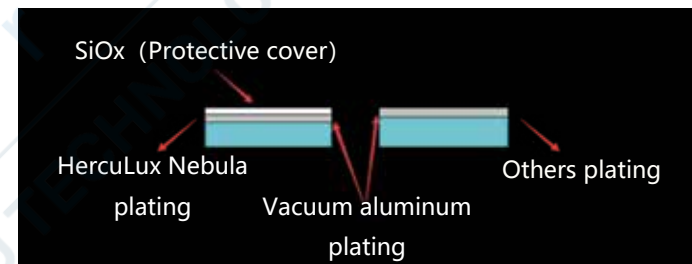

1、 Assembly:

Easy assembling own buckle design and supporting holder design, easy for assembling and precise positioning

2、 Flexible replacement:

Easy Changing By special buckle and supporting holder and holder design, can easy change the reflector to get different beam angle in project site;

3、 Coating technology:

SiOx plating Automotive-grade reflective glass vacuum Plating technology of aluminum and SiOx, separate air and the aluminum plating, Superior anti-corrosion performance, can pass NaOH Alkali solution testing.

NEBULA



NEBULA 44@20

φ: 44mm H: 20mm
Material: Vacuum Aluminum Plating PC
FWHM: 15°/24°/36°
Efficiency: 90%



NEBULA 75@54

φ: 75mm H: 54mm
Material: Vacuum Aluminum Plating PC
FWHM: 15°/24°/36°
Efficiency: 90%



NEBULA 50@35

φ: 50mm H: 35mm
Material: Vacuum Aluminum Plating PC
FWHM: 15°/24°/36°
Efficiency: 90%



NEBULA 95@64

φ: 95mm H: 64mm
Material: Vacuum Aluminum Plating PC
FWHM: 15°/24°/36°
Efficiency: 90%



NEBULA 69@46

φ: 69mm H: 46mm
Material: Vacuum Aluminum Plating PC
FWHM: 15°/24°/36°
Efficiency: 90%



LIGHTNING

Adapted the calculus and Fresnel technology, have good effect although the short height assemble, and lower UGR importantly.

Principle

Adapted the calculus and Fresnel technology, have good effect although the short height assemble, and lower UGR importantly.

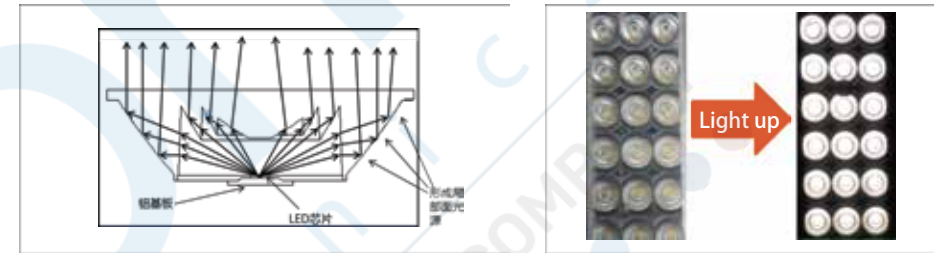

Appearance

HercuLux adopted the calculus and Fresnel technology, make the lens looked beautiful, the scales' space create the similar effect like the grid when lighting, and the surface brightness is more downy. Own technology, enough patents.

Structure

- 1、Injecting the glue from the module front surface, upper is bigger than the under, can achieve the lens zero clearance assembled.
- 2、Optical PC material, enough heat and weather resistance, UL-94: V2; UV cut : f1.

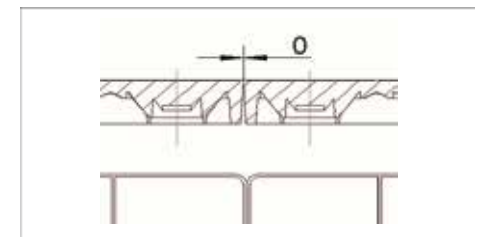

UGR

UGR In our optical designing experience, the better angle for the office lighting is 80°, lower UGR



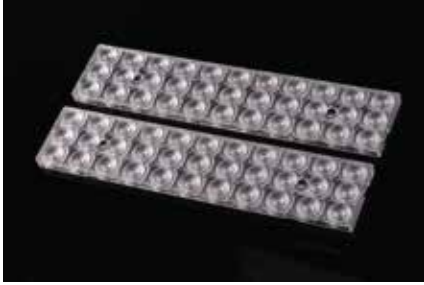

LIGHTNING

HK-286@10-XX-3030-22-1g-33

Size: L:286mm W:61mm

FWHM: 30°/60°/80°

Material: PC

Efficiency: 86%

Application: Linear Light

Lens by LED:

SMD 3030/2835

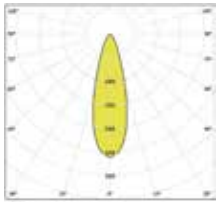

30°

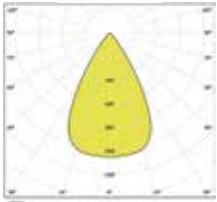

60°

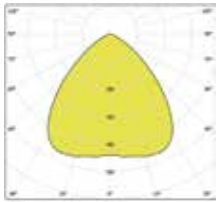

80°



LIGHTNING

HK-286@10-XX-3030-22-1g-3

Size: L:286mm W:61mm

FWHM: Asymmetric/Double asymmetric

Material: PC

Efficiency: 86%

Application: Linear Light

Lens by LED:

SMD 3030/2835

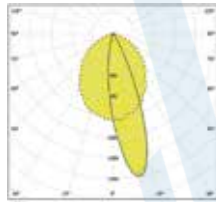

Asymmetric

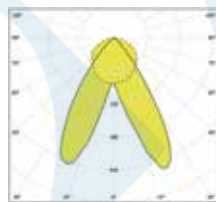

Double asymmetric



LIGHTNING

HK-286@08-XX-3030-22-1g-33

Size: L:286mm W:61mm

FWHM: 30°/60°/80°

Material: PMMA

Efficiency: 88%

Application: Linear Light

Lens by LED:

SMD 3030/2835



30°

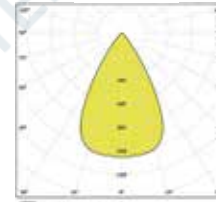

60°

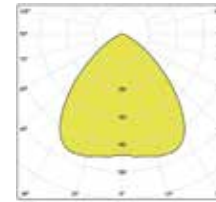

80°



LIGHTNING

HK-286@08-XX-3030-22-1g-33

Size: L:286mm W:61mm

FWHM: Asymmetric/Double asymmetric

Material: PMMA

Efficiency: 88%

Application: Linear Light

Lens by LED:

SMD 3030/2835

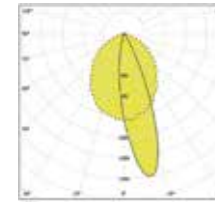

单偏

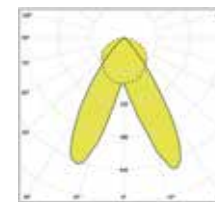

双偏



COMET

Original Calculus imitated COB Technology

Application: Down Light/

PAR 16 PAR20/ PAR30/ PAR38



COMET

HK-45@13-XX-3030-22-1g-1

Size: Φ : 45 mm H: 13.3mm

FWHM: 30°

Material: PC

Efficiency: 88%

Application: PAR16、 Down Light

Lens by LED:

Copy COB: 6PCS 3030 , 6PCS 2835



COMET

HK-51@16-XX-3030-22-1g-1

Size: Φ : 51.3 mm H: 16.3mm

FWHM: 25°/40°

Material: PC

Efficiency: 88%

Application: PAR20、 Down Light

Lens by LED:

Copy COB: 6PCS 3030 , 6PCS 2835



COMET

HK-73@20-XX-3030-22-1g-1

Size: Φ : 73.3 mm H: 20.3mm

FWHM: 25°/40°

Material: PC

Efficiency: 88%

Application: PAR30、 Down Light

Lens by LED:

Copy COB: 6PCS 3030 , 6PCS 2835



COMET

HK-83@24-XX-3030-22-1g-1

Size: Φ : 94.2 mm H: 24mm

FWHM: 25°/40°

Material: PC

Efficiency: 88%

Application: PAR38、 Down Light

Lens by LED:

Copy COB: 6PCS 3030 , 6PCS 2835

CUSTOMIZED SOLUTIONS

In addition to the standard mold products introduced in the catalogue, HercuLux can also provide customized solution services. With a professional design team and a complete industrial chain, tailor-made for customers, seeking the best solution for the project.

Extended Polynomial Lens

The Extended Polynomial surface shape is defined by:

$$z = \frac{cr^2}{1 + \sqrt{1 - (1+k)c^2r^2}} + \sum_{i=1}^N A_i E_i(x, y).$$

HercuLux adopts imaging optical design software: ZEmax to do data input level design to achieve more accurate chip level design.

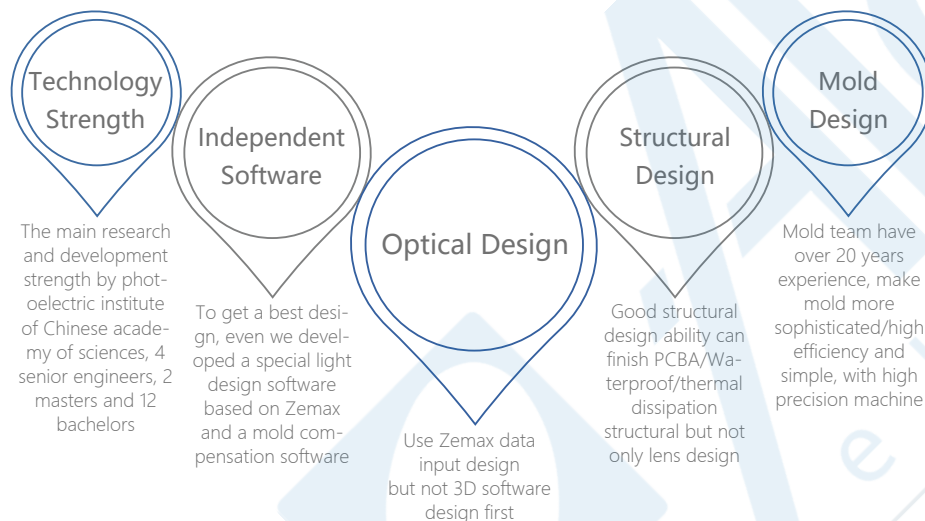

and use Light tools or Tracpro to test and then adjust, can get more sophisticated high-order free-form surface

Quick response for Design: Optical design → Structural design → Optical simulation → Mold assess → Injection molding analysis

Optical design, structural design, mold design, injection molding production, quality inspection, HercuLux has a complete industrial chain to ensure that optical products can be independently controlled in each link, so that product quality, appearance, performance and other aspects are the best state!

Custom Process

Kindly provide detail requirements:

1. Lens size requirement; 2. Optical requirement(FWHM),Target IES will be better; 3. Lens Efficiency; 4. Assembly drawing sharing; 5. LED; 6. Material: PC or PMMA; 7. Application; 8. Other special information.

Optical Design Report:

Our R&D will process to optical designing according to your optical requirement, designing in 2-5 days and we will share you the design report.

Structure Design:

If you are satisfied with the optical report, we could process to structure designing. Please kindly provide the assembly drawing, structure drawing and any file is helpful for us to design structure.

Structure Confirm:

Confirm the structure (Step file): 1. Whether the lens structure conflict with the PCB; 2. Whether the lens structure conflict with the Lamp's structure; 3. Whether the lens structure conflict with the component location; 4. etc.

Quotation:

Quotation for Mold and product: 1. It depends on the mold size and its complexity; 2. Quotation includes Test Mold fee and Final Mold fee and price for unit product. (Test Mold is not absolutely necessary, it is according to the complexity of the mold.)

Customer PO Arrangement:

After you confirm the quotation, please kindly share your PO.

PI and Payment Arrangement:

We will arrange PI and we process to payment issue. After payment is done, we will process to mold production.

Mold Production:

We need 30-35 working days to produce the mold, then will send you the samples which mold produce when the mold finished.

Confirm The Samples:

Whether the samples is same with the optical design and structure design.

Mass Production: If the samples checking is OK, Procedure as below, 1. Your mass order; 2. Our PI arrangement; 3. Your payment arrangement; 4. Mass production.

Self-built 20000 m² HercuLux park



More than 100 precision injection machines



Complete mold processing chain with a constant temp precision processing area



Self-built PC Vacuum Aluminum Plating workshop, One Spraying Production Line, Two Vacuum Plating Machine, 100000 Level Purification Workshop

