

# EXL1V0402

## High current molded inductor



- High current carrying capacity
- Low DCR, high efficiency
- Magnetically shielded, low EMI
- Soft saturation
- Inductance range from 0.47  $\mu$ H to 3.3  $\mu$ H
- Current range from 4.4 A to 13.2 A
- 4.6 mm x 4.6 mm footprint surface mount package in a 2.1 mm height
- Alloy powder core material
- Moisture Sensitivity Level (MSL) 1

### Applications

- Voltage regulator module (VRM)
- Multi-phase regulators
- Point-of-load (POL) converters
- Desktop and server VRMs and EVRDs
- Base station equipment
- Laptop and notebook regulators
- Tablets and e-readers
- Cellular phones
- Battery power systems
- Graphics cards
- Data networking and storage system

### Environmental compliance and general specifications

- Storage temperature range (Component): -40 °C to +125 °C
- Operating temperature range: -40 °C to +125 °C (ambient plus self-temperature rise)
- Solder reflow temperature: J-STD-020 (latest revision) compliant



Product specifications

Part number <sup>5</sup>	Part marking designator	OCL <sup>1</sup> (μH) ± 20%	FLL <sup>2</sup> (μH) minimum	I <sub>rms</sub> <sup>3</sup> (A) typical +20 °C rise	+40 °C rise	I <sub>sat</sub> <sup>4</sup> (A)	DCR (mΩ) typical @ +25 °C	DCR (mΩ) maximum @ +25 °C	SRF (MHz) typical
EXL1V0402-R47-R	A	0.47	0.26	9.8	13.2	12.5	6.0	6.8	90
EXL1V0402-R56-R	B	0.56	0.31	9.5	12.6	11.3	6.9	7.8	85
EXL1V0402-R60-R	C	0.60	0.33	9.4	12.4	11.1	6.9	7.8	85
EXL1V0402-R68-R	D	0.68	0.38	9.2	12	10	7.3	8.2	73
EXL1V0402-R82-R	E	0.82	0.45	8.5	11.5	9.0	8.6	9.5	62
EXL1V0402-1R0-R	F	1.0	0.56	8.0	11	8.0	10.6	11.7	56
EXL1V0402-1R2-R	G	1.2	0.67	7.2	9.5	7.5	12.2	13.4	53
EXL1V0402-1R5-R	H	1.5	0.84	6.7	9.1	6.7	14.4	15.8	45
EXL1V0402-2R0-R	I	2.0	1.12	6.2	8.2	5.0	21.15	23.3	40
EXL1V0402-2R2-R	J	2.2	1.23	6.0	8.0	4.8	21.35	23.5	38
EXL1V0402-3R3-R	K	3.3	1.84	4.4	5.5	4.4	34.2	38.3	26

1. Open circuit inductance (OCL) Test parameters: 100 kHz, 0.1 V<sub>max</sub>, 0.0 Adc, +25 °C

2. Full load inductance (FLL) Test parameters: 100 kHz, 0.1 V<sub>max</sub>, I<sub>sat</sub>, +25 °C

3. I<sub>sat</sub>: Heat rated current (I<sub>sat</sub>) will cause the part temperature rise approximately ΔT of 40 °C. Circuit design, component, PCB trace size and thickness, airflow and other cooling provisions all affect the part temperature. Part temperature should be verified in the end application. The part temperature (ambient + temperature rise) should not exceed +125 °C under worst case operating conditions.

4. I<sub>sat</sub>: Peak current for approximately 30% rolloff @ +25 °C

5. Part Number Definition: EXL1V0402-xxx-R

EXL1V0402 = Product code and size

xxx= inductance value in μH, R= decimal point,

If no R is present then third digit equals the number of zeros

-R suffix = RoHS compliant

6. Rated operating voltage: 15 V typical

Mechanical parameters, schematic, pad layout (mm)

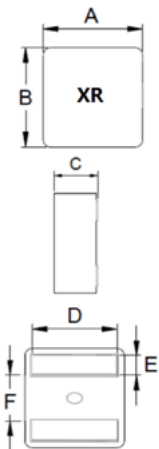

Recommended pad layout

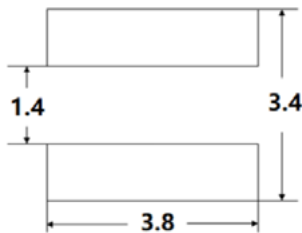

Schematic



Figure 1. DCR test

Part number	A	B	C	D	E	F
EXL1V0402-xxx-R	4.4 ± 0.20	4.4 ± 0.20	1.9 ± 0.20	3.4 ± 0.30	0.88 ± 0.20	1.6 ± 0.25

Part marking: 1st digit = Inductance value per the "Part marking designator" letter code in specification table, 2nd digit = revision level

All soldering surfaces to be coplanar within 0.1 millimeters

Tolerances are ± 0.3 millimeters unless stated otherwise

Dimensions of recommended PCB layout are reference only.

Pad layout tolerances are ± 0.1 millimeters unless stated otherwise

Four terminal kelvin-clip recommended for DCR testing as shown in Figure 1.

Traces or vias underneath the inductor is not recommended

**Packaging information (mm)**

Drawing not to scale

Supplied in tape and reel packaging, 3000 parts per 13" diameter reel (EIA-481 compliant)

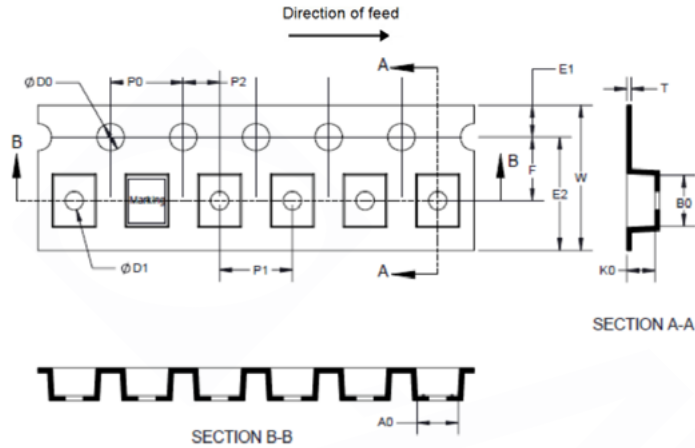

W ± 0.30	12.00
F ± 0.5	5.50
E1 ± 0.10	1.75
P0 ± 0.10	4.00
P1 ± 0.10	8.00
P2 ± 0.05	2.00
D0 + 0.10/-0	1.50
D1 + 0.10/-0	1.50
A0 ± 0.10	4.70
B0 ± 0.10	4.70
K0 ± 0.10	2.30
T ± 0.05	0.35
P0 X 10 ± 0.20	40.0

**Qualification testing**

No.	Test item	Reference standards	Test condition	Acceptable value/range
1	Life	MIL-STD-202 Method 108	+125 °C + I <sub>rms</sub> for 1000 hours	a. Appearance b. ΔL/L<±10% d. ΔR/R<±15%
2	Load humidity	MIL-STD-202 Method 103	+85 °C/85% RH + I <sub>rms</sub> for 1000 hours	a. Appearance b. ΔL/L<±10% d. ΔR/R<±15%
3	Moisture resistance	MIL-STD-202 Method 106	7a & 7b included	a. Appearance b. ΔL/L<±10% d. ΔR/R<±15%
4	Thermal shock	MIL-STD-202 Method 107	Step 1: -40 ± 2 °C 30 ± 5 minutes Step 2: 25 ± 2 °C ≤ 0.5 minutes Step 3: 125 ± 2 °C 30 ± 5 minutes Number of cycles: 500	a. Appearance b. ΔL/L<±10% d. ΔR/R<±15%
5	Vibration	MIL-STD-202 Method 204	10 g, 12 hours (10 Hz ~ 2 kHz ~ 10 Hz for 20 minutes, 12 cycles each of 3 orientations)	a. Appearance b. ΔL/L<±10% d. ΔR/R<±15%
6	Shock	MIL-STD-202 Method 213	Half-sine 50 g's, 11 ms	a. Appearance b. ΔL/L<±10% d. ΔR/R<±15%
7	Bending	IEC 68-2-21	1.2 mm for 10 s	a. Appearance b. ΔL/L<±10% d. ΔR/R<±15%
8	Solderability	J-STD-002D Method B	Preheat: +150 °C, 60 sec. 245 ± 5, Dip time: 4 ± 1 sec. Depth: completely cover the termination	≥ 95% of the terminal covered with solder
9	Resistance to soldering heat	MIL-STD-202 Method 210	+260 ± 5 °C; 10 ± 1 s	a. Appearance b. ΔL/L<±10% d. ΔR/R<±15%
10	Terminal strength	AEC-Q200-006	1 kg for 60 + 1 s	a. Appearance b. ΔL/L<±10% d. ΔR/R<±15%

Inductance and temperature rise vs. current

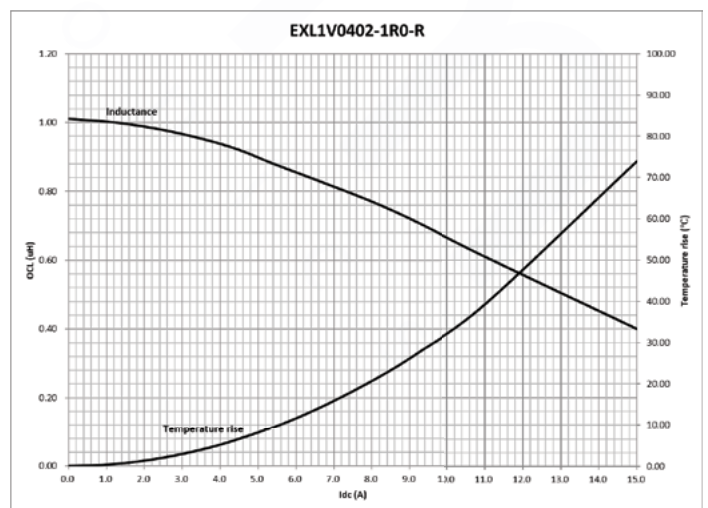
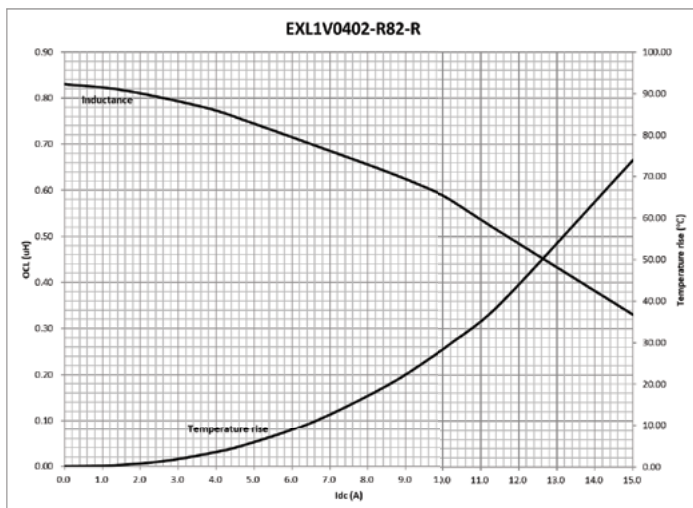
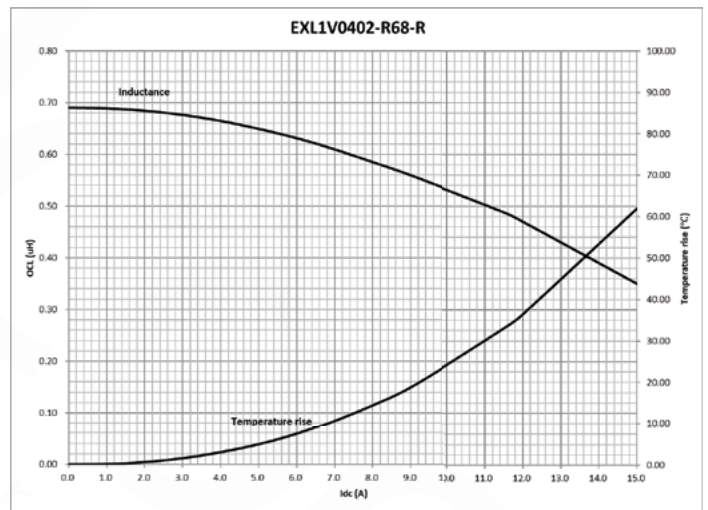
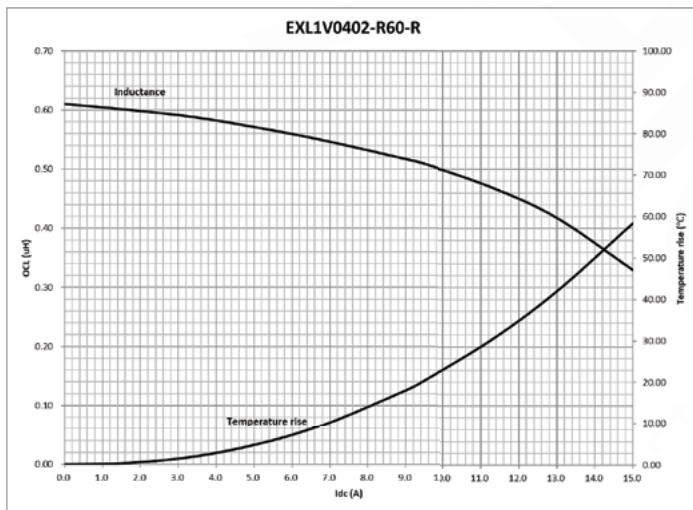
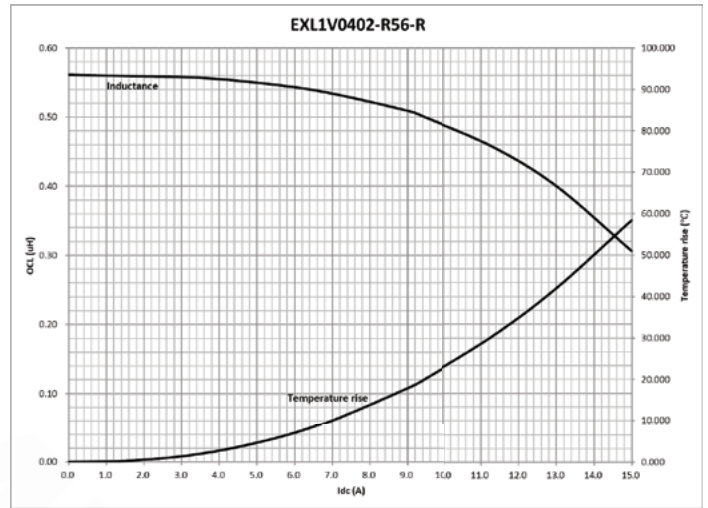
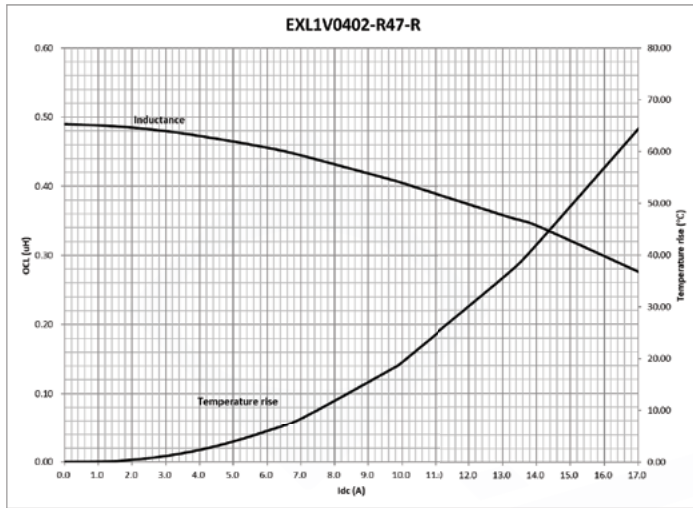

Inductance and temperature rise vs. current, continued

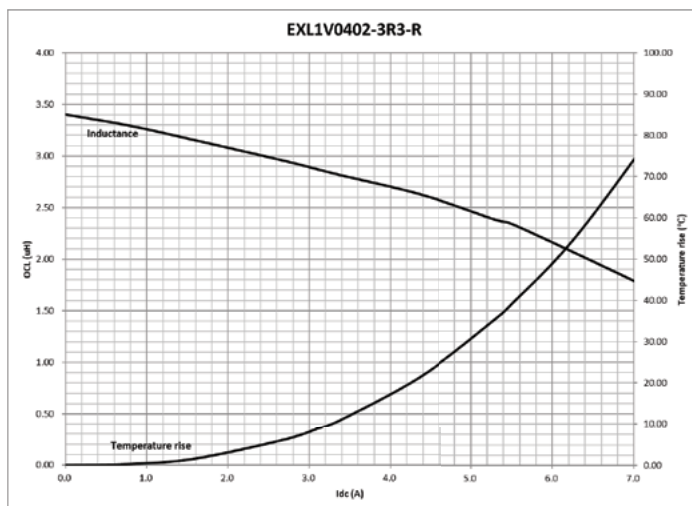
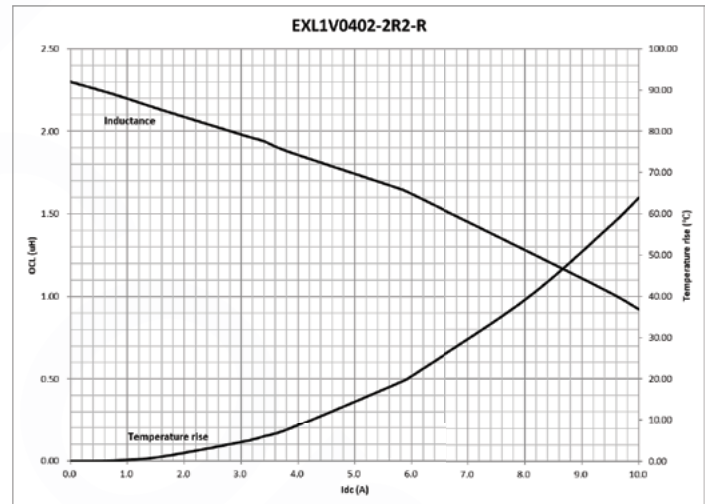
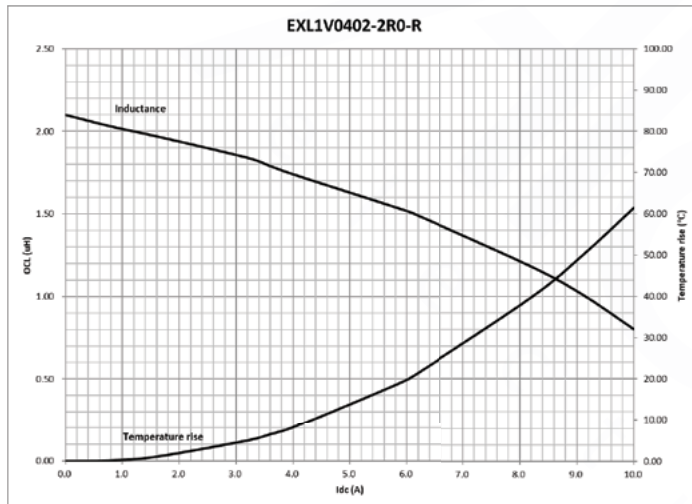
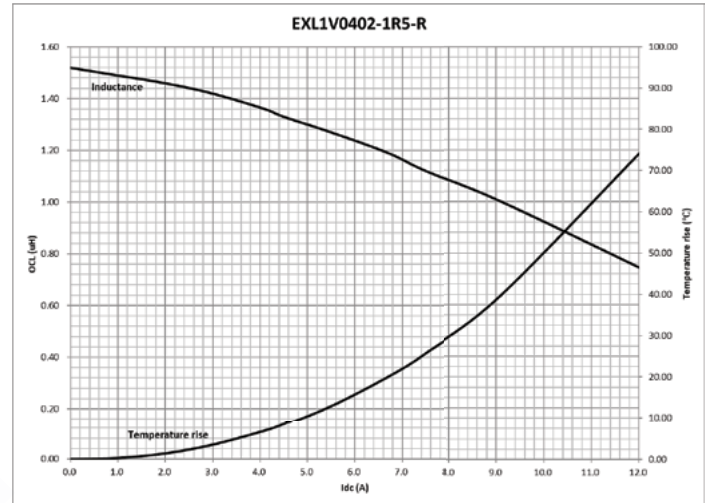
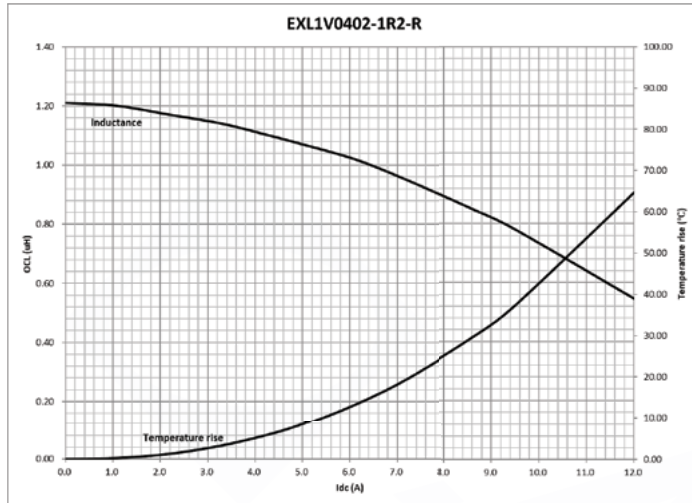

Inductance and impedance vs. frequency curve

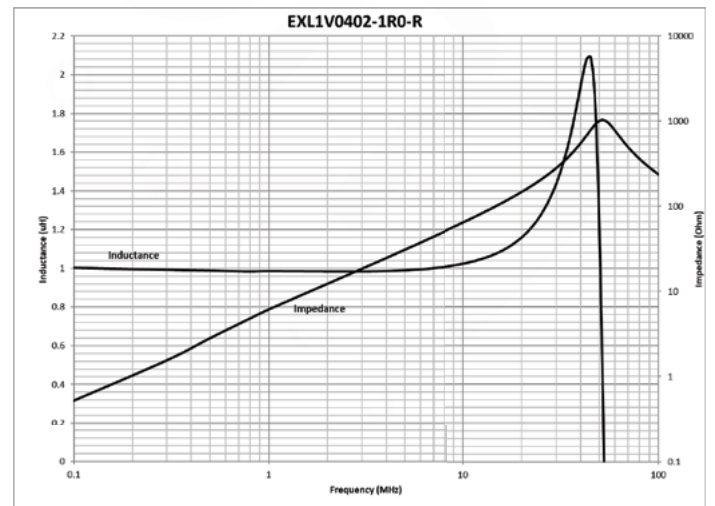
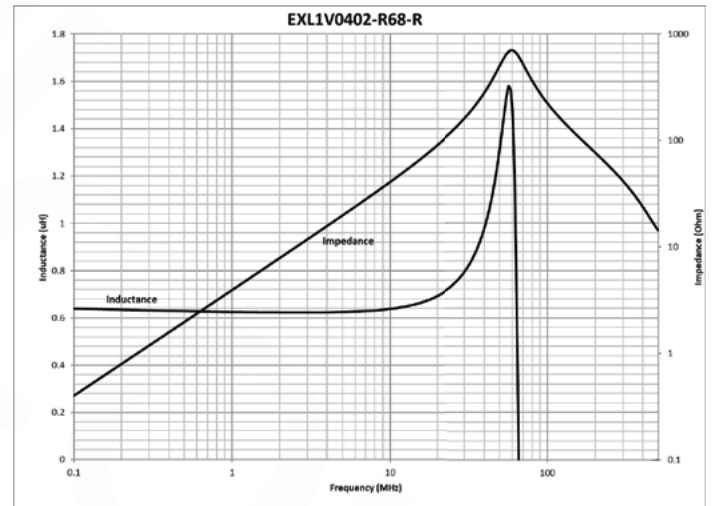
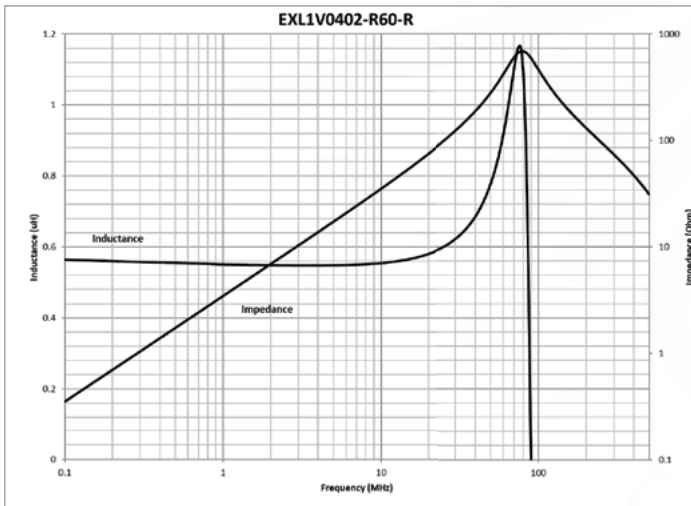
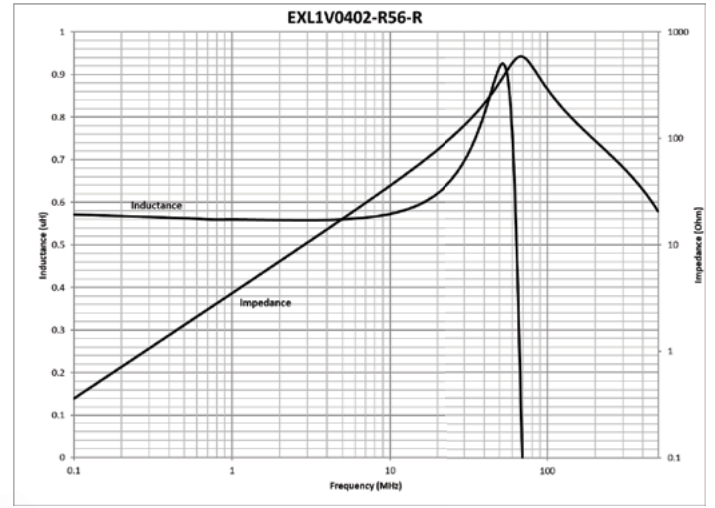
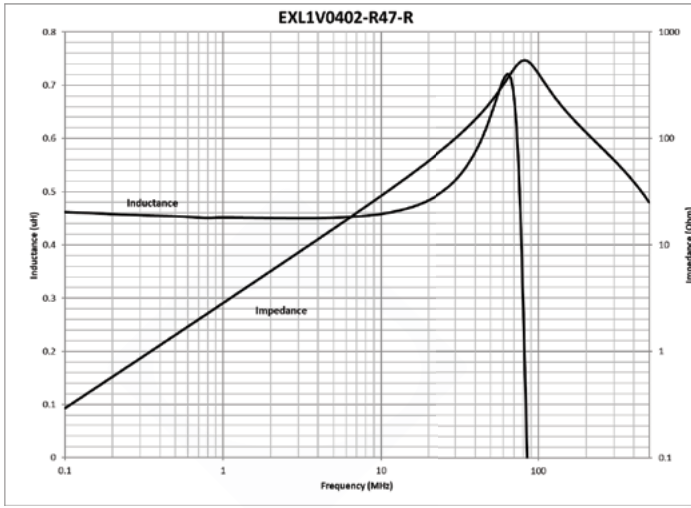



Inductance and impedance vs. frequency curve, continued

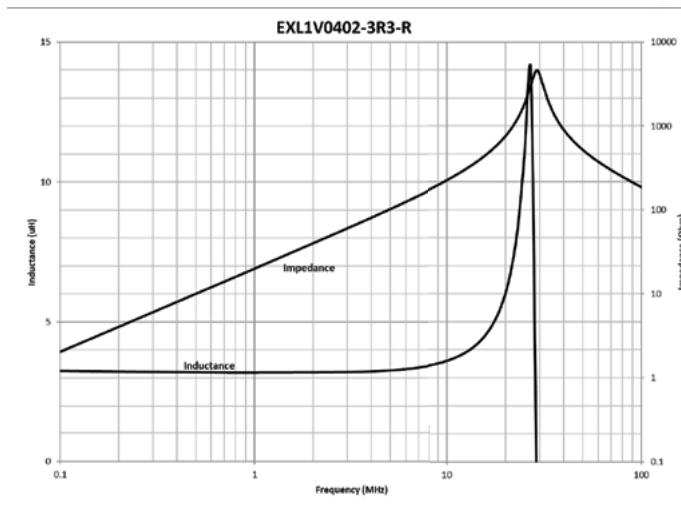
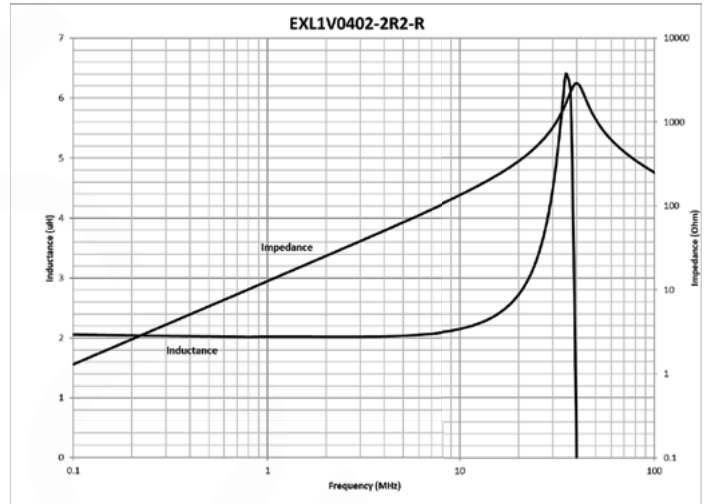
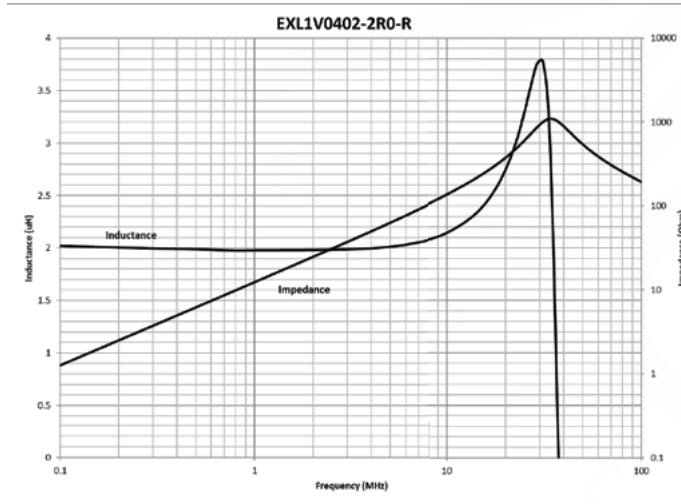
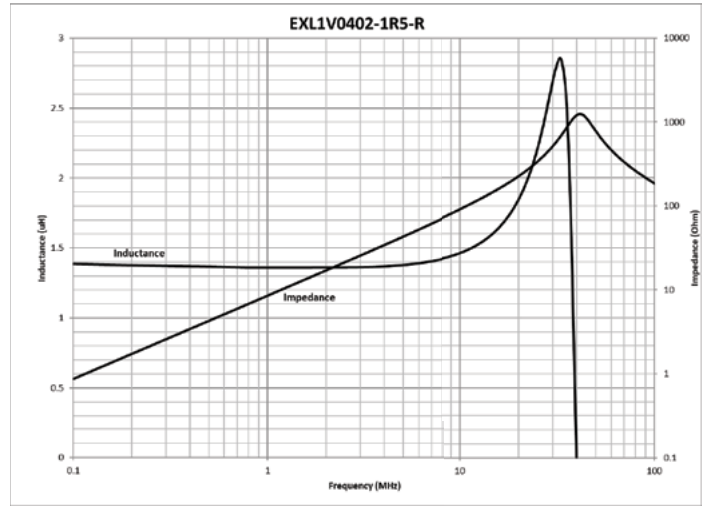
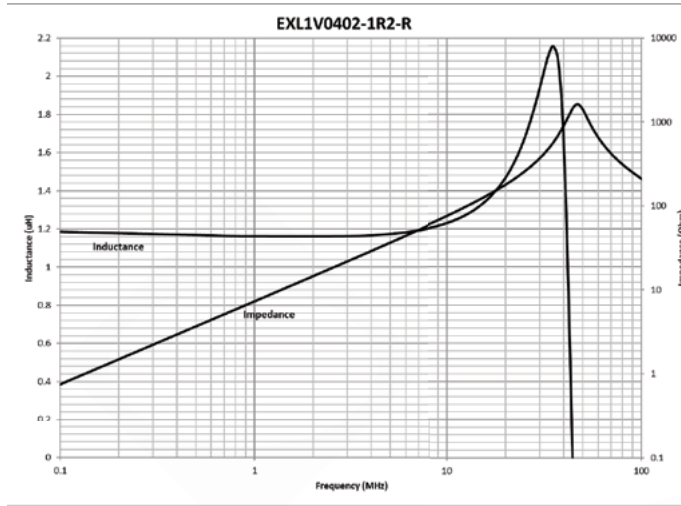

**Solder reflow profile**

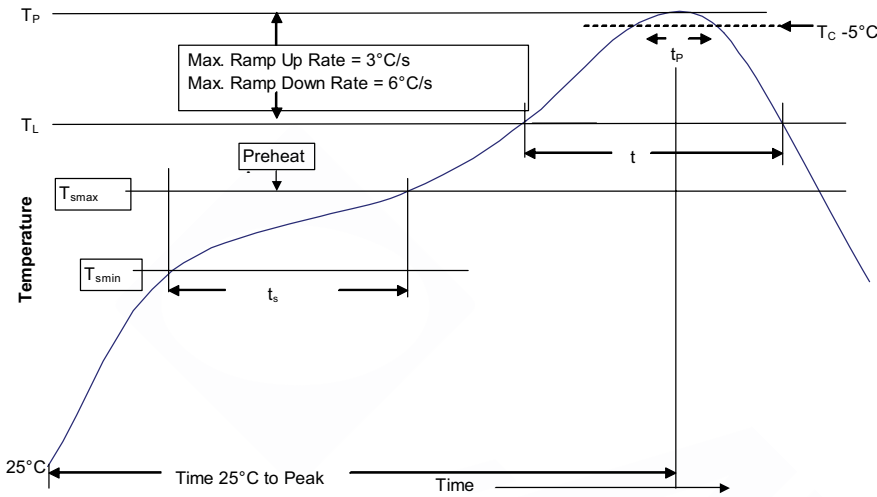

**Table 1 - Standard SnPb solder ( $T_C$ )**

Package thickness	Volume mm <sup>3</sup> <350	Volume mm <sup>3</sup> ≥350
<2.5 mm	235 °C	220 °C
≥2.5 mm	220 °C	220 °C

**Table 2 - Lead (Pb) free solder ( $T_C$ )**

Package thickness	Volume mm <sup>3</sup> <350	Volume mm <sup>3</sup> 350 - 2000	Volume mm <sup>3</sup> >2000
<1.6 mm	260 °C	260 °C	260 °C
1.6 – 2.5 mm	260 °C	250 °C	245 °C
>2.5 mm	250 °C	245 °C	245 °C

**Reference J-STD-020**

Profile feature	Standard SnPb solder	Lead (Pb) free solder
Preheat and soak		
• Temperature min. ( $T_{smin}$ )	100 °C	150 °C
• Temperature max. ( $T_{smax}$ )	150 °C	200 °C
• Time ( $T_{smin}$ to $T_{smax}$ ) ( $t_s$ )	60-120 seconds	60-120 seconds
Ramp up rate $T_L$ to $T_p$	3 °C/ second max.	3 °C/ second max.
Liquidous temperature ( $T_L$ )	183 °C	217 °C
Time ( $t_L$ ) maintained above $T_L$	60-150 seconds	60-150 seconds
Peak package body temperature ( $T_p$ )*	Table 1	Table 2
Time ( $t_p$ )* within 5 °C of the specified classification temperature ( $T_C$ )	20 seconds*	30 seconds*
Ramp-down rate ( $T_p$ to $T_L$ )	6 °C/ second max.	6 °C/ second max.
Time 25 °C to peak temperature	6 minutes max.	8 minutes max.

\* Tolerance for peak profile temperature ( $T_p$ ) is defined as a supplier minimum and a user maximum.

Life Support Policy: Eaton does not authorize the use of any of its products for use in life support devices or systems without the express written approval of an officer of the Company. Life support systems are devices which support or sustain life, and whose failure to perform, when properly used in accordance with instructions for use provided in the labeling, can be reasonably expected to result in significant injury to the user.

Eaton reserves the right, without notice, to change design or construction of any products and to discontinue or limit distribution of any products. Eaton also reserves the right to change or update, without notice, any technical information contained in this bulletin.

**Eaton**  
Electronics Division  
1000 Eaton Boulevard  
Cleveland, OH 44122  
United States  
Eaton.com/electronics



Singel 3 | B-2550 Kontich | Belgium | Tel. +32 (0)3 458 30 33  
info@alcom.be | www.alcom.be  
Rivium 1e straat 52 | 2909 LE Capelle aan den IJssel | The Netherlands  
Tel. +31 (0)10 288 25 00 | info@alcom.nl | www.alcom.nl