



Analog and Mixed-Signal Power and Protection Semiconductors



Kinetic Technologies & Alcom



Kinetic Technologies designs, develops and markets proprietary high-performance analog and mixed-signal power and protection semiconductors across consumer, communications, industrial, automotive and enterprise markets, to deliver protected solutions tolerant of real-world fault conditions. The company's products sit "Behind Every Port™", deliver solutions to not only manage, protect, regulate, and monitor power consumed by analog and digital semiconductors and other electronic loads, but also to switch, transform and protect high resolution video, audio, and data signals.

Contact your Alcom sales contact to learn more about Kinetic. We are able to support our customers with technical design support and any commercial question by a dedicated team of people.

Co-creation starts here

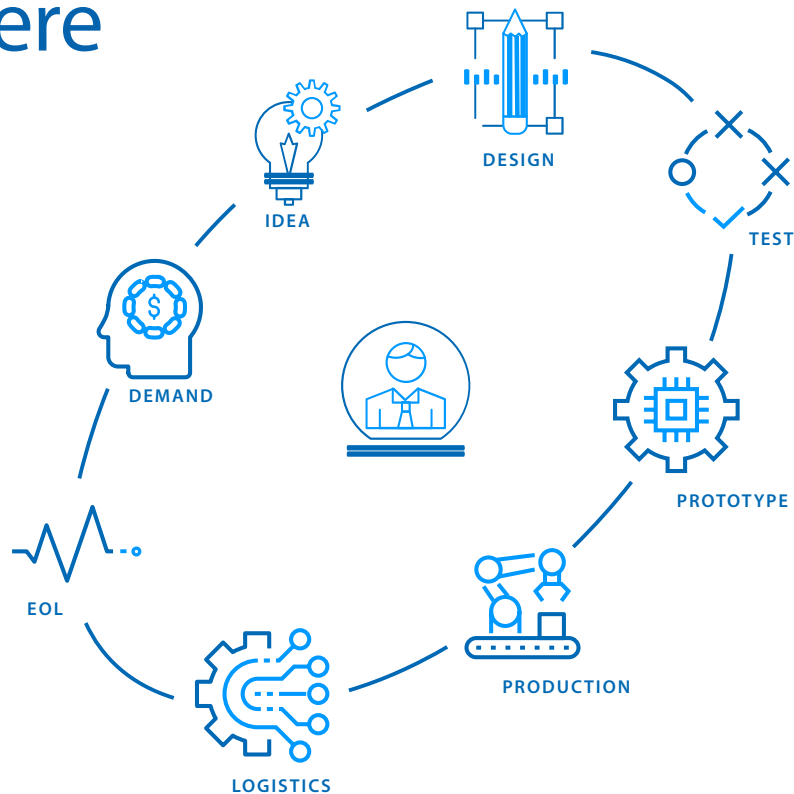

Alcom considers everybody an indispensable added value in the collaborative chain with all of its partners.



Applications & Markets



E-MOBILITY



AUTOMOTIVE



HOME & BUILDING AUTOMATION



MOTOR CONTROL



MEDICAL, HEALTHCARE



SECURITY & SURVEILLANCE



FACTORY & INDUSTRIAL
AUTOMATION AND ROBOTICS



WEARABLES & MOBILE



KIOSK, POS AND DIGITAL SIGNAGE

Product Portfolio & End Markets

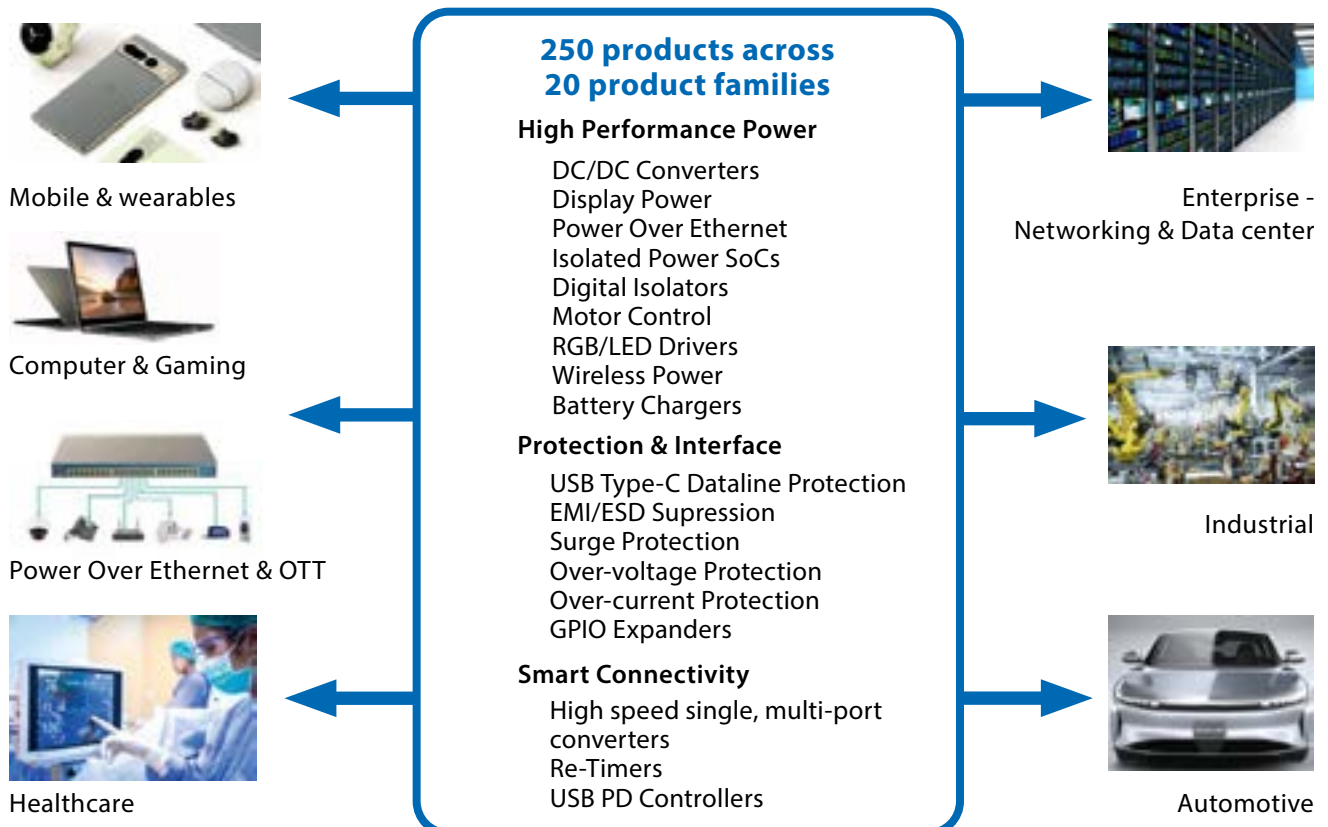

Product Overview

Protection & System monitoring

- Overvoltage and Surge Protection ICs
- USB Data Line Protection ICs
- EMI/ESD Suppression
- Smart Push Button Reset ICs

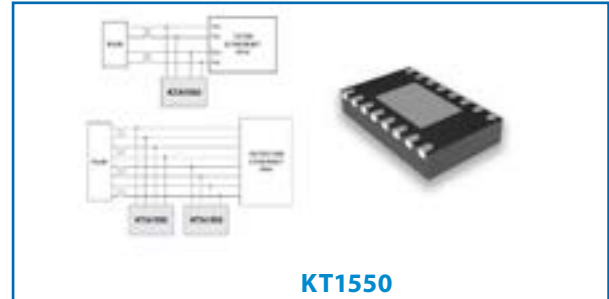

Interface & Isolation

- General-purpose input/output (GPIO) technology
- Load Switches: Slew-rate controlled Load Switches are inserted between the battery or supply voltage and a load, and only turned on when the load is required by the system, thereby minimizing the power drain.



Display Power

- Camera LED Flash Drivers
- RGB LED Driver ICs
- LED Backlight Drivers ICs
- LCD Bias Supply ICs

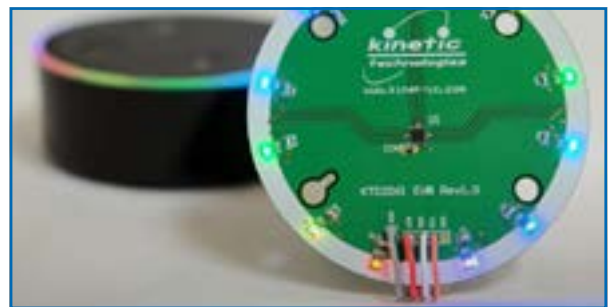

DC to DC Conversion

Kinetic technologies offer families of isolated and non-isolated DC-DC regulators

- Non-Isolated DC-DC Conversion
- Isolated DC-DC Conversion



Product Overview

Charging

Wireless Power Receiver

- 5W/15W Wireless Power Receiver for WPC/Qi BPP
 - Low Cost 5W Wireless Power Receiver
 - 3W Wireless Power Receiver with Linear Charger
- Wireless Power Transmitter

- 5W Wireless Power Transmitter for WPC/QiBPP



Power Over Ethernet

Power over Ethernet (PoE) Powered Device (PD) product solutions integrate the PD and DC-DC controller functions into a single package, which can also include the high voltage switching output MOSFET.

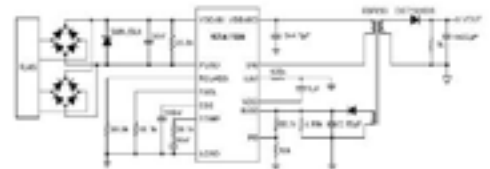

KT1136

Motor Control

With one of the world's first independent motor winding control techniques, Kinetic enables extremely high efficiency in 3-phase BLDC motors. Our products control standard 3-phase BLDC motor, stepper motors and proprietary BLDC independent winding motors.

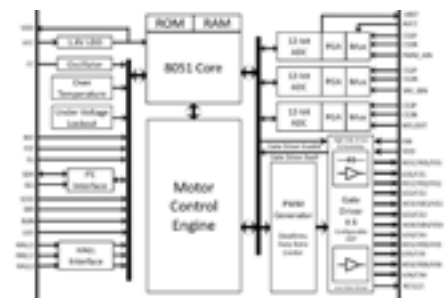

KTX9612

New product releases

EEE 802.3AF POE PD WITH INTEGRATED DC/DC CONTROLLER AND 13W POWERFET

The KTA1136 is a single-chip, highly integrated CMOS solution for 13W Power over Ethernet (PoE) Powered Devices. Applications include Voice over IP (VoIP) Phones, Wireless LAN Access Point, Security Cameras, WiMAX Terminals, Point-of-Sales Terminals, RFID Readers, Thin Clients and Notebook computers. The KTA1136 integrates input surge protection, a PD controller with a 100V hot-swap FET, a DC-DC controller, and a robust 150V switching power MOSFET.

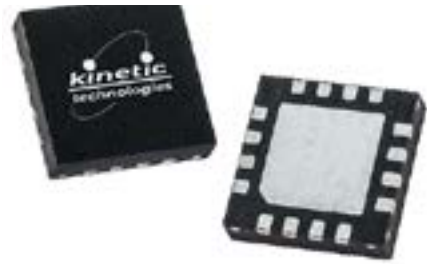

3-PHASE BLDC MOTOR CONTROLLER FOR 3-WIRE WITH BUILT-IN GATE DRIVERS

The KTX9312 is a motor controller IC, the third generation solution in Kinetic's patented PURESINE™ technology family. Specifically designed for all standard sinusoidal Permanent Magnet Synchronous Motor (PMSM) 3-wire 3 phase BLDC motors, offering the unique benefits of a monolithic hybrid ASIC architecture with advanced control, monitoring, torque, speed and position detection. Evaluation kit available.

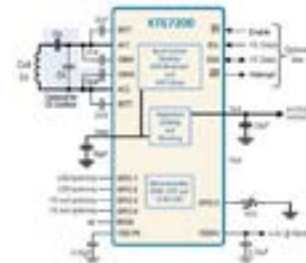

LOW COST 5W WIRELESS POWER RECEIVER

KTE7200 is a robust single chip wireless power receiver optimized for low cost, low component count, and low cost PCB designs. This device is optimized for small low power devices with small coils, while also being capable of as much as 5 watts of output with an appropriate thermal design.

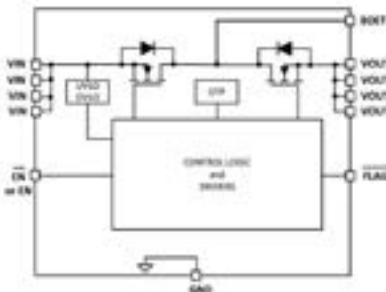

AUTOMOTIVE LOAD SWITCH WITH OVP AND RB PROTECTION

The KTS1642Q is a cutting-edge load switch, safeguarding systems from power issues with an operating range from 4V to 40V. With low-resistance MOSFET switch (41mΩ) and features like over-voltage protection, auto-retry, and an Enable pin for shutdown, it is ideal for diverse applications, from automotive to industrial systems.

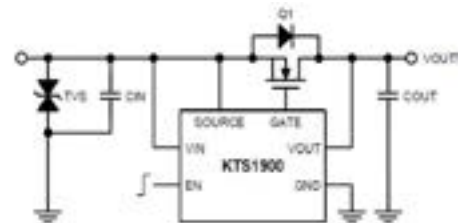

IDEAL DIODE AND LOAD SWITCH CONTROLLER

The KTS1900 is an ideal diode and load switch controller with reverse input protection. It has an internal charge pump to enable the use of an N-channel MOSFET with low on-resistance to replace a Schottky diode or a P-channel MOSFET based solution. It also can be used with two Back-to-Back MOSFETs for Load switching and Inrush Control. With low on-resistance N-Channel MOSFET, the lower forward voltage drops, less power dissipation, and heat dissipation can be achieved.

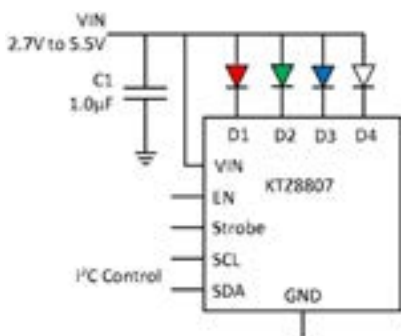

FEATURE-RICH RGB LED DRIVERS PROVIDING THE SMALLEST FOOTPRINTS

RGB LED Drivers ICs are used to generate and control 3 different voltages and currents required to illuminate RGB LEDs used as visual indicators in portable appliances such as Smartphones, Tablets, Smart WiFi Speakers and other portable appliances. 4-channel, 3-channel or 36-channel output options are available, suitable for RGBW or single and multiple RGB applications.

Alcom product portfolio

ELECTRONIC COMPONENT SOLUTIONS	WIRELESS EMBEDDED CONNECTIVITY & SENSORS	WIRELESS & INDUSTRIAL CONTROLS NETWORKING	DISPLAY & TOUCH
LED & SOLID STATE LIGHTING	POWER & EMC	RUGGED MOBILE COMPUTING	EMBEDDED SYSTEMS, AI & EDGE COMPUTING

<ul style="list-style-type: none"> • Semiconductors • Frequency & timing • Power management • Circuit protection & discretes • Magnetics • Passives & electromechanical • Connectors & cable assemblies • Photonics 	<ul style="list-style-type: none"> • Wireless modules • Antenna's • Sensors
<ul style="list-style-type: none"> • Routers & gateways • Wireless embedded computers • Industrial ethernet and IP variations • Wired & wireless machine networking • Antenna's • Device to cloud solutions • Connectivity & remote management services • Networking & connectivity 	<ul style="list-style-type: none"> • Displays • Touch screens • Optical bonding • Total display solutions
<ul style="list-style-type: none"> • LED light sources • Optics • Thermal management • Power & intelligent controls • LED modules 	<ul style="list-style-type: none"> • AC/DC power supplies • DC/DC converters • Power management modules • Wireless charging • E-mobility solutions • Transformers & power inductors • UPS • EMC filters
<ul style="list-style-type: none"> • Tablets • PDA's • Vehicle mount computers • Accessories 	<ul style="list-style-type: none"> • Computer-on-modules • Embedded boards • Industrial PC & automation • System integration

Bridging the gap between technology, people and business with a human interface.





ALCOM BELGIUM

Alcom electronics nv/sa
Singel 3
2550 Kontich
Tel: +32 (0)3 458 30 33
Fax: +32 (0)3 458 31 26
Email: info@alcom.be
www.alcom.be

ALCOM THE NETHERLANDS

Alcom Electronics B.V.
Rivium 1e straat 52
2909 LE Capelle a/d IJssel
Tel: +31 (0)10 288 25 00
Fax: +31 (0)10 288 25 25
Email: info@alcom.nl
www.alcom.nl

Get to know us

ALCOM PROVIDES THE WORLD'S MOST ADVANCED TECHNOLOGIES.

With a team of like-minded entrepreneurs, Alcom will continue to inspire its valued customers to use advanced innovative building blocks in vertical markets. The importance of providing high-level services and a human interface based on specialism, knowledge and design-in expertise will remain key differentiators.

Alcom is positioned for growth. We invite all our customers to discuss their current and future concepts and designs. Let's connect, work and grow together.

