

NEVO+600M

MEDICAL DATA SHEET

AC/DC Modular Configurable PSU



600W

Powerful

5" x 3" x 1.61"

Small

600g

Light

600 Watts in the palm of your hand

The NEVO+600M modular configurable medical power supply is the smallest in its class and the ultimate solution for demanding medical applications where size, power density and weight matter. Its tiny footprint of 5" x 3" x 1.61" weighs only 600 grams and delivers an incredible 600 Watts - equating to a power density of 25 Watts per cubic inch. The input module can accommodate up to four isolated output modules which can be configured into a high power 5" x 3" single output power supply or a multiple output power supply with up to 8 isolated outputs. Standard features include intelligent fan control providing optimised airflow for various load and temperature conditions, wide output voltage adjust, parallel and series connection of modules and an isolated 5V 1A bias supply. A low noise fan option is available that allows you to use this innovative power supply in even the quietest of environments. The series is approved to latest medical standards and features market leading specifications and design in application support.

MAIN FEATURES

- | | | |
|--|---|--|
| • 600 Watts in 5" x 3" x 1.61" | • Efficiency up to 89% | • Up to 8 isolated outputs |
| • User and field configurable | • Intelligent fan control | • Low noise option (ML version) |
| • Wide output voltage adjust range | • Parallel & series connection of modules | • IEC/UL60601-1 Ed. 3 & -1-2 Ed. 4 (EMC) |
| • Remote current & voltage programming | • Standard 5V 1A bias supply | • 3 Year warranty |
| | • Accurate current sharing | |

APPLICATIONS

- | | | |
|----------------------------------|-----------------------------------|---------------------------|
| • Medical & diagnostic equipment | • Telecommunications | • Lasers |
| • Test & Measurement equipment | • Laboratory & Analysis equipment | • LED lighting |
| • Robotics | • Display | • Retrofit of legacy PSUs |
| • Oil & Gas | • Avionics | |

CUSTOMER BENEFITS

- | | | |
|------------------------------------|----------------------------------|---------------------------------|
| • Fast time to market | • Proven technology | • Technology consolidation |
| • 24 hrs samples from distribution | • Eliminates custom design costs | • Supplier consolidation |
| • Safety & EMC certified | • Field replaceable | • Redundant manufacturing sites |
| • World class engineering support | • Low cost of ownership | |

SPECIFICATIONS

INPUT MODULE SPECIFICATIONS					
Parameter	Details	Min	Typical	Max	Units
AC Input Voltage	Nominal range is 100V _{RMS} to 240V _{RMS}	85		264	V _{RMS}
AC Input Frequency	Contact factory for 400Hz operation.	47	50/60	63	Hz
DC Input Voltage	Not covered by safety approvals. Contact Vox Power.	120		300	V _{DC}
Output Power Rating	De-rate linearly from 600Watts at 120V _{RMS} to 450Watts at 85V _{RMS}			600	Watts
Input Current	600Watts output at 120 V _{RMS} input			6	Amps
Input Current Limit	Maintains power factor		8		Amps
Inrush Current	265V _{RMS} , 25°C (cold start)			20	Amps
Fusing	Live line fused (5x20 Fast acting)			8	Amps
Efficiency	See graphs		86	89	%
No load Power consumption	All outputs fitted and disabled/enabled		21/28		Watts
Power Factor	Typical value for 300 Watts output at 240Vrms input		0.96	0.99	
Holdup	600Watts output at 120V _{RMS} input	17	20	21	mS
UVP	Turn on under voltage protection	78		84	V _{RMS}
Over temperature	Internally monitored.	115		125	°C
Reliability ⁽¹⁾	Input module			1.207	FPMH
	Fan			2.7	FPMH
Warranty	Standard terms and conditions apply			3	Years
Size	133.7 (L) x 77.7 (W) x 41.0 (H). See diagram for tolerance details				mm
Weight	360 + 60 per output module				Grams
Note 1.	30°C base & ambient, 100% load, SR332 Issue 2 Method I, Case 3, Ground, Fixed, Controlled				

GLOBAL SIGNALS SPECIFICATIONS					
Parameter	Details	Min	Typical	Max	Units
Bias Voltage		4.8	5	5.2	Volts
Bias Current				1	Amps
AC_OK Voltage	Low output level/High output level	0/4.8	0.2/5	1/5.2	Volts
AC_OK Current		-10		20	mA
Power Good Voltage	PNP open collector with internal 10kΩ pull down. Low output level/High output level	0/8	0/10	0/15	Volts
Power Good Current	Open collector output. Current source only. All Slots.			20	mA
Global Inhibit Voltage	Low input level/High input level.	0/3		1/15	Volts
Global Inhibit Current	5k input impedance.	0.6		3	mA
Inhibit Voltage	Low input level/High input level. All slots.	0/2.5		1/15	Volts
Inhibit Current	10k input impedance. All slots.	0.25		1.5	mA

OUTPUT MODULE SPECIFICATION SUMMARY												
MODEL	Output Voltage			Output Current	Rated Power	Peak Power	Load Reg.	Line Reg.	Cross Reg.	Ripple & Noise	FPMH ⁽¹⁾	Feature Set ⁽²⁾
	Min.	Nom.	Max.									
OP1	1.5V	5V	7.5V	25A	125W	187.5W	±50mV	±5mV	±10mV	50mV _{PP}	0.5	ABCDEFGF
OP2	4.5V	12V	15V	15A	150W	225W	±100mV	±12mV	±24mV	120mV _{PP}	0.5	ABCDEFGF
OP3	9V	24V	30V	7.5A	150W	225W	±150mV	±24mV	±48mV	240mV _{PP}	0.5	ABCDEFGF
OP4	18V	48V	58V	3.75A	150W	217.5W	±300mV	±48mV	±96mV	480mV _{PP}	0.5	ABCDEFGF
OP5	3.3V	12V	15V	5A	2x 75W	2x 75W	±50mV	±12mV	±24mV	240mV _{PP}	0.75	AFG
OP8	23.2V	24V	24.7V	3.125A	2x 75W	2x 75W	±100mV	±24mV	±48mV	480mV _{PP}	0.75	AFG
OPA2 ⁽³⁾	4.5V	12V	15V	25A	300W	375W	±100mV	±12mV	±24mV	120mV _{PP}	0.5	ABCDEFGFH
OPA3 ⁽³⁾	9V	24V	30V	15A	300W	450W	±150mV	±24mV	±48mV	240mV _{PP}	0.5	ABCDEFGFH
Note 1.	Output module, 30°C base, 100% load, SR332 issue 2 Method I, Case 3, Ground, Fixed, Controlled											
Note 2.	A = Remote Sense, B = External Voltage control, C = External constant current control, D = Current output signal, E = Current share, F = Over Voltage protection, G = Over temperature protection, H = Dual Slot module											
Note 3.	Can only be used with NEVO+600 chassis with date codes from 2048 onwards. eg. 2048C080000 can use A2 or A3 module, 2047C089999 cannot use A2 or A3 module.											

SAFETY SPECIFICATIONS			
Parameter	Details	Max	Units
Isolation Voltages	Input to Output (2 MOPP). Do not perform test on assembled unit ⁽¹⁾	4000	V _{AC}
	Input to Chassis (1 MOPP)	1500	V _{AC}
	Global signals (J2) to Output/Chassis	250	V _{DC}
	Output to Output/Chassis (Standard modules)	250	V _{DC}
Earth Leakage Current	Normal condition, 264Vac, 63Hz, 25°C	300	uA
Touch Leakage Current	Standard modules NC/SFC	20/200	uA
Patient Leakage Current	Standard modules 264Vac, 63Hz, 25°C NC/SFC ⁽²⁾	-----	uA
Note 1.	Testing an assembled unit to 4000V _{AC} may cause damage. Please refer to application note (APN-002) on Vox Power website or contact Vox Power representative.		
Note 2.	Not Applicable		

INSTALLATION SPECIFICATIONS			
Parameter	Details	Parameter	Details
Equipment class	I	Flammability Rating	94V-2
Overvoltage category	II	Ingress protection rating	IP10
Material Group	IIIb (indoor use only)	ROHS compliance	2011/65/EU
Pollution degree	2	Intended usage environment	Home Healthcare

ENVIRONMENTAL SPECIFICATIONS						
Parameter	Details	Non-Operational		Operational		Units
		Min	Max	Min	Max	
Air Temperature	Operational limits subject to appropriate de-ratings	-40	+85	-20	70	°C
Humidity	Relative, non-condensing	5	95	5	95	%
Altitude		-200	5000	-200	3000	m
Air Pressure		52	106	69	106	kPa
Noise Level	Variable. Measured 1m from fan intake.	-	-	36	60	dBa
Shock	3000 bumps at 10G (16ms) half sine wave					
Vibration	1.5G 10 to 200Hz sine wave, 20G for 15min in 3 axes random vibration					

ELECTROMAGNETIC COMPLIANCE – EMISSIONS		
Phenomenon	Basic EMC Standard	Test Details
Radiated emissions, electric field	EN55011/22, FCC	Class B compliant
Conducted emissions	EN55011/22, FCC part 15, CISPR 22/11	Class B compliant
Harmonic Distortion	IEC61000-3-2	Compliant
Flicker & Fluctuation	IEC61000-3-3	Compliant

ELECTROMAGNETIC COMPLIANCE – IMMUNITY		
Phenomenon	Basic EMC Standard	Test Details
Electrostatic discharge	IEC61000-4-2	Test level 4: 15kV air, 8kV contact
Radiated RF EM fields	IEC61000-4-3	Test Level 3: (10V/m, 80MHz-2.7GHz) sine wave AM 80% 1kHz
Proximity fields from RF wireless communications equipment	IEC61000-4-3	Test levels as per IEC60601-1-2:2014 Table 9
Electrical Fast Transients/bursts	IEC61000-4-4	Test Level 3: (2kV Power, 1kV I/O) 5kHz(ed3) & 100kHz(ed4)
Surges	IEC61000-4-5	Test Level 3: 1kV L-N, 2kV L-E
Conducted disturbances induced by RF fields	IEC61000-4-6	Test Level 3: 10V, 0.15 to 80Mhz sine wave AM 80% 1kHz
Power Frequency Magnetic Fields	IEC61000-4-8	Test level 4: 30A/m 50Hz
Voltage Dips	IEC61000-4-11& SEMI-F47-0706 (2)	0% 10ms, 0% 20ms, 80% 1s, 80% 10s, 90% continuous (Criterion A) 70% 0.5s, 40% 0.2s (Criterion A at 240V and Criterion B at 100V)
Voltage interruptions	IEC61000-4-11	0% 250/300 cycle as per IEC60601-1-2:2014 (Criterion B)

Notes:

- Criterion A = No degradation of performance or loss of function.
Criterion B = Temporary degradation of performance or loss of function is allowed, provided the function is self-recoverable.
Criterion C = Temporary loss of function is allowed but requires operator intervention to recover.
- Tested at nominal range (100V to 240V). Line deratings applied where appropriate.

AGENCY APPROVALS		
Standard	Details	File
IEC 60601-1:2005 + CORR1 2006 + CORR2: 2007 + A1:2012	Medical electrical equipment Part 1: General requirements for basic safety and essential performance	UL: E316486
EN60601-1:2006 + A11:2011 + A1:2013 + A12:2014	Medical electrical equipment Part 1: General requirements for basic safety and essential performance	
CAN/CSA-C22.2 No. 60601-1 (2008)	Medical Electrical Equipment Part 1: General Requirements for Basic Safety and Essential Performance	
ANSI/AAMI ES60601-1 (2005 + C1:09 + A2:10)	Medical Electrical Equipment Part 1: General Requirements for Basic Safety and Essential Performance	
CE MARK	LVD 2014/35/EU, EMC 2014/30/EU	

CB certificate and report available on request

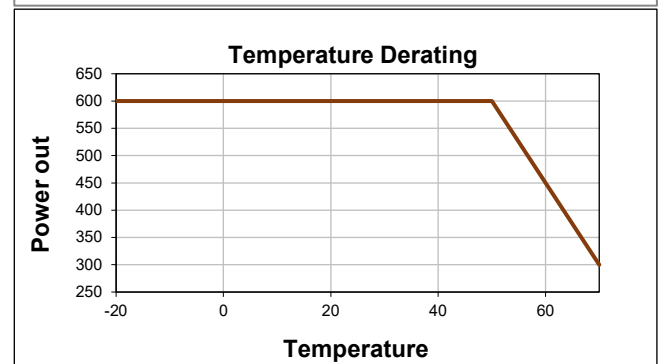
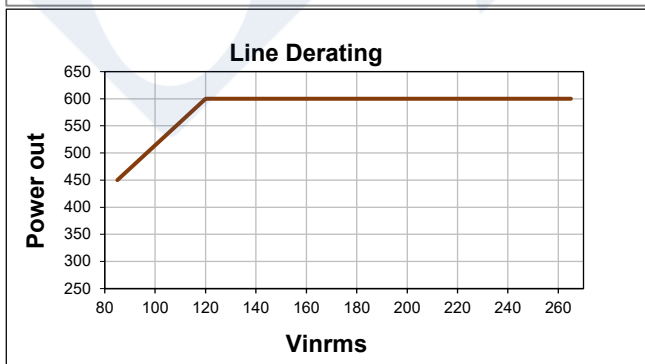
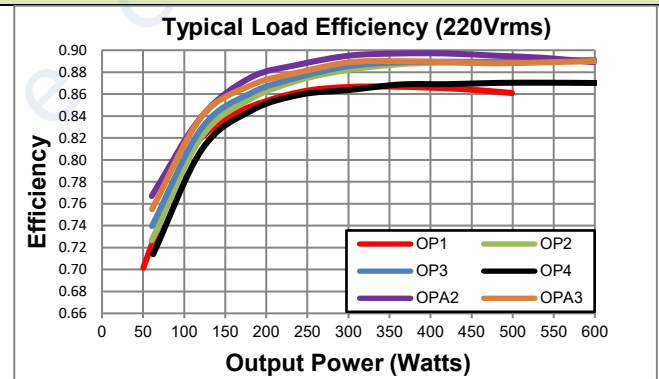
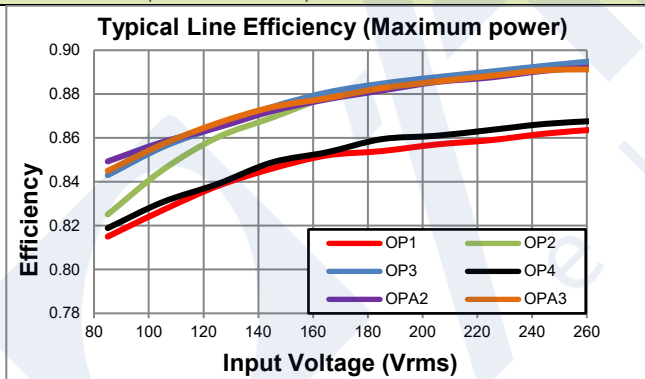

MECHANICAL DIMENSIONS AND MOUNTING SCREWS

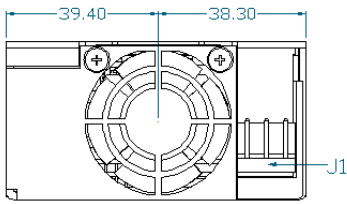

N - Neutral
E - Earth
L - Live

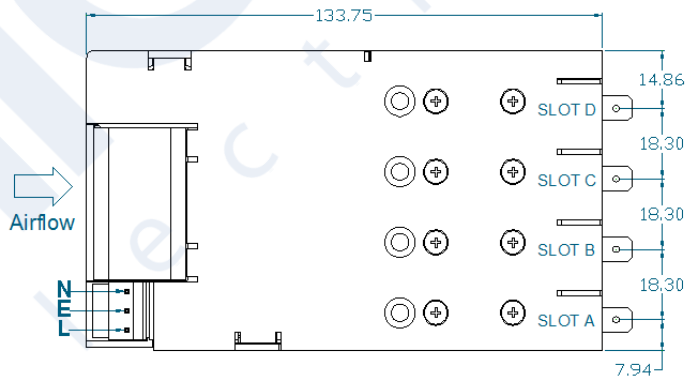
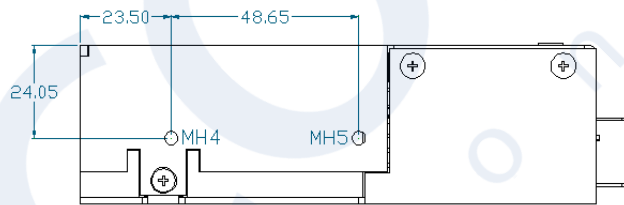
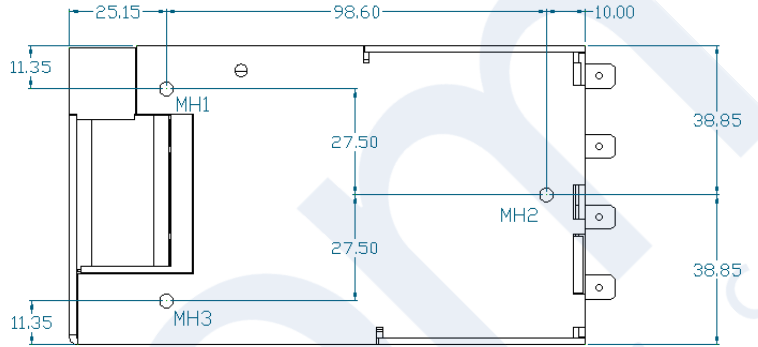
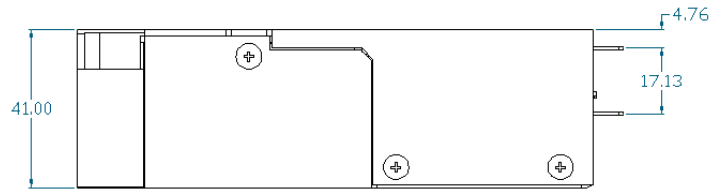

SCREWS

MH1, MH2, MH3, MH4, MH5	
Screw type	M4
Tightening	Tighten to 0.5 Nm ⁽¹⁾
Penetration depth	4.00mm max including chassis

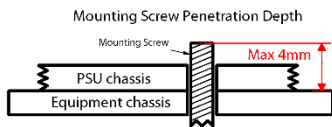

OUTPUT MODULES x 8

Screw type	M3x5, C/Sink, Posi, Stainless Steel
Tightening	Tighten to 0.50 Nm ⁽¹⁾
Penetration depth	Defined by screw

CHASSIS x 5

Screw type	M3x5, C/Sink, Posi, Stainless Steel
Tightening	Tighten to 0.50 Nm ⁽¹⁾
Penetration depth	Defined by screw

FAN x 2

Screw type	M3x30, C/Sink, Posi, Stainless Steel
Tightening	Tighten to 0.50 Nm ⁽¹⁾
Penetration depth	Defined by screw

1. Torque settings are for general reference only. The torque settings shown in the datasheet are the insert manufacturers recommended values.

CONNECTORS

PINOUTS	
J1	
Circuit	Details
1	Live
2	Earth
3	Neutral
J2	
Circuit	Details
1	Power good
2	Inhibit
3	Power good
4	Inhibit
5	Power good
6	Inhibit
7	Power good
8	Inhibit
9	Global inhibit
10	AC OK
11	+5V 1A bias supply
12	COM
J5 ⁽⁴⁾	
Circuit	Details
1	-Sense
2	+Sense
3	Voltage control
4	Current control / share / out
5	COM
6	+5V 10mA local bias supply

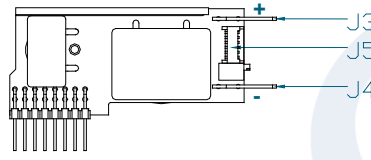
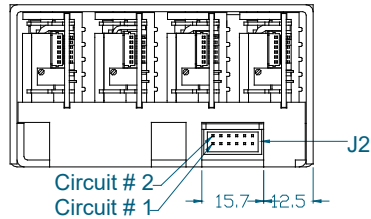
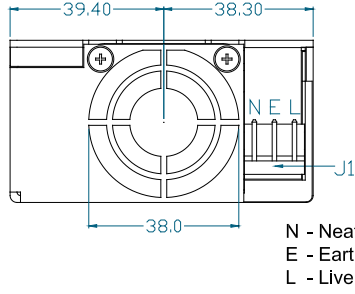

J3
Positive output
J4
Negative output

REF.	DETAILS	MANUFACTURER	HOUSING	TERMINAL
J1	MAINS INPUT: 3 Pin, 5.08mm, with Friction Lock, 18-24 AWG	MOLEX	10013036	0008701031
J2	GLOBAL SIGNALS: 12 Pin, 2mm, without Friction Lock, 24-30 AWG	MOLEX	511101251	0503948051
J3/4 ⁽¹⁾	OUTPUT POWER TERMINAL: TAB SIZE 6.35mmx0.8mm	VARIOUS		VARIOUS
J5	OUTPUT SIGNALS: 6 Pin, 1.25mm, with Friction lock, 28-32 AWG	MOLEX	0510210600	0500588000

Notes

- Terminal and wire current rating must exceed maximum short circuit output current. Eg. Output 1 = 25A*1.25 = 31.25Amps
- Direct equivalents may be used for any connector parts
- All cables must be rated 105°C min, equivalent to UL1015
- Pinout is for single output types only

PART NUMBERING SYSTEM

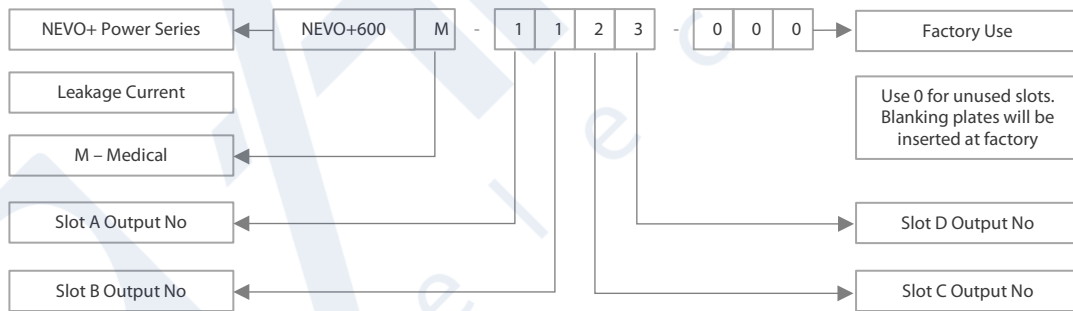

Our design team will assist with value-add requirement if an application requires standard/non-standard accessories or non-nominal voltage settings. Once approved, the factory will issue a 3 or 4 digit code for your specific configuration which can be used for all future orders of the same configuration. When ordering an input unit with no outputs inserted, simply order NEVO+600M

All specifications are believed to be correct at time of publishing. Vox Power Ltd reserves the right to make changes to any of its products and to change or improve any part of the specification, electrical or mechanical design or manufacturing process without notice. Vox Power Ltd does not assume any liability arising out of the use or application of any of its products and of any information to the maximum extent permitted by law. No license, express or implied, by estoppel or otherwise, to any intellectual property rights is granted by this document or by any products of Vox Power Ltd. VOX POWER LTD DISCLAIMS ALL WARRANTIES AND REPRESENTATIONS OF ANY KIND WHETHER EXPRESS OR IMPLIED, INCLUDING, BUT NOT LIMITED TO, IMPLIED WARRANTIES OF SUITABILITY, FITNESS FOR PURPOSE, MERCHANTABILITY AND NON-INFRINGEMENT.

Please consult your local distributor or Vox Power directly to ensure that you have the latest revision before using the product and refer to the latest relevant user manual for further information relating to the use of the product. Vox Power Ltd products are not intended for use in connection with life support systems, human implantations, nuclear facilities or systems, aircraft, spacecraft, military or naval missile, ground support or control equipment used for the purpose of guidance navigation or direction of any aircraft, spacecraft or military or naval missile or any other application where product failure could lead to loss of life or catastrophic property damage. The user will hold Vox Power Ltd harmless from any loss, cost or damage resulting from its breach of these provisions.