

KEY FEATURES

- Open Frame Medical Switching Power Supply
- Remote ON/OFF Function
- 240 Watt with Free Air Convection
- 500 Watt with 30CFM FAN Forced Air
- 4000VAC Input to Output 2MOPP Insulation
- Built-in 12V/0.3A Auxiliary Output
- Standby 5V@1A with Fan, @0.4A without Fan
- High Efficiency up to 93%
- With P.F.C. Function >0.94
- Current Share Function for Option (except for 15S)
- Suitable for BF Application with Appropriate System Consideration
- Ultra Compact Size: 5.03 x 3.0 x 1.38 Inches
- 3-Year Product Warranty



ELECTRICAL SPECIFICATIONS

All specifications valid at normal input voltage, full load and +25°C after warm-up time unless otherwise stated.

Model No.		MQF5000-12S	MQF5000-15S	MQF5000-24S	MQF5000-48S	
Max Output Wattage (W)		500 W (30CFM FAN)				
Max Output Wattage (W)		Others: 230 W (115 VAC) / 240 W (230 VAC)				
		15S: 210 W (115 VAC) / 220 W (230 VAC)				
Input	Voltage (Note 3)	90-264 VAC or 127-370 VDC				
	Frequency (Hz)	47-63 Hz				
	Current (Full load)	< 6.3 A max. (115 VAC) / <3.15 A max. (230 VAC)				
	Inrush Current (<2ms) (Clod Start)	< 40 A max. (115 VAC) / < 80 A max. (230 VAC)				
	Leakage Current	< 0.1mA / 264 VAC (Touch Current)				
	Power Factor (at 230 VAC)	PF>0.94 at Full Load				
Output	Voltage (V.DC.)	12V	15V	24V	48V	
	Voltage Accuracy	±2%				
	Voltage Adj. Range (V.DC)	±4% Output Voltage				
	Current (with 30CFM FAN) (A) (max.)	41.5	33.3	20.8	10.41	
	Current (Free air Convection) (A) max	at 115 VAC	19.16	14	9.58	4.8
		at 230 VAC	20	14.66	10	5
	Line Regulation (115-264 VAC)	±0.5%				
	Load Regulation (10-100%) (typ.)	±1%				
	Minimum Load	3%				
	Maximum Capacitive Load	5,000µF	3,750µF	2,500µF	1,250µF	
	Ripple & Noise (typ.)	160mV	160mV	240mV	480mV	
	Efficiency (at 230 VAC)	90.5%	90.5%	92%	93%	
Hold-up Time (at 115 VAC)	8 ms min.					
Protection	Over Power Protection	Auto recovery				
	Over Voltage Protection	Auto recovery				
	Over Temperature Protection	Auto recovery				
	Short Circuit Protection	Protection level 1 (nominal) : Continuous, Auto recovery				
Protection level 2 (instantaneous high current) : Latch						
Isolation	Input-Output (V.AC)	4000VAC or 5656VDC				
	Input-PE (V.AC)	2000V				
	Output-PE (V.AC)	1500V				

ELECTRICAL SPECIFICATIONS

All specifications valid at normal input voltage, full load and +25°C after warm-up time unless otherwise stated.

Model No.	MQF5000-12S	MQF5000-15S	MQF5000-24S	MQF5000-48S
Environment	Operating Temperature	-30°C...+70°C (with derating)		
	Storage Temperature	-35°C...+85°C		
	Temperature Coefficient	±0.03%/°C (0~50°C)		
		±0.06%/°C (-30~0°C)		
	Altitude During Operation	5000m		
	Humidity	95% RH		
	Atmospheric Pressure	56 kPa to 106 kPa		
	MTBF	>160,000 h @ 25°C (MIL-HDBK-217F)		
	Vibration	IEC60068-2-6 (10~500Hz, 2G 10min./1cycle, 60min. each along X, Y, Z axes)		
Shock	IEC60068-2-27			
Physical	Dimensions (L x W x H)	5.03 x 3.0 x 1.38 Inches (127.8 x 76.2 x 35.0 mm) Tolerance ±0.5 mm		
	Weight	480 g		
	Cooling Method	Free convection / 30 CFM FAN		
Safety	Approval	12S/24S/48S: UL / IEC / EN 60601 3.1 st Edition (2 x MOPP) , UL / IEC / EN 60950 AM2, UL / IEC / EN 62368		
	Approval / Meet	15S: UL / IEC / EN 60601 3.1 st Edition (2 x MOPP) , UL / IEC / EN 60950 AM2 (meet), UL / IEC / EN 62368 (meet)		
EMC	Conducted and Radiated EMI	EN55011 / conducted class B, Radiated Class A		
	EMS	EN60601-1-2 4th edition		

NOTE

1. Ripple & Noise are measured at 20MHz of bandwidth with ceramic 0.1uF & chemi-con KY 47uF parallel capacitor.

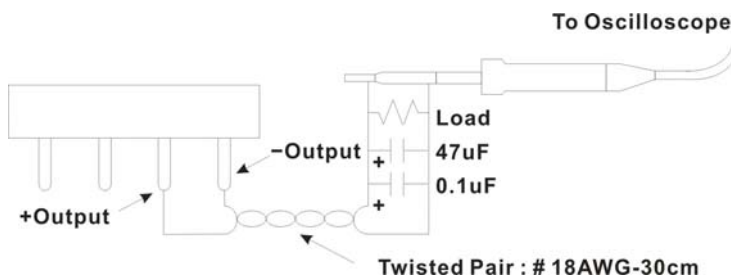

A 30cm twisted pair of no.18 AWG copper wire is connected to a 47uF and 0.1uF capacitor of proper polarity and voltage rating. The oscilloscope probe ground led should connect right to the ground ring of the probe and be as short as possible. The oscilloscope bandwidth should be at 20MHz and connected to AC ground.

2. Hold-up Time measured at 90% Vout.
3. Please check the derating curve for more details.
4. Main Vout >3% Load, 12V (Aux) / 0.3A., 12V (Aux) need 0.1A Minimum Load, Auxiliary voltage output ground 10.2~13.3V
5. Strongly recommend to conduct this test with DC Voltage. If customer wishes to test with AC Voltage, please disconnect all Y-Capacitors from Arch power supply.

NOTE

6. Current Share Board (Optional):

- (a.)The output voltage difference of each parallel single element should be less than 0.2V.
- (b.)Output power at parallel operation = rated power per unit x number of unit x 90%
- (c.)Connect in parallel no more than 2 units. Please contact ARCH for advice if more than 2 is needed.
- (d.)Minimum Load Should be 15%.

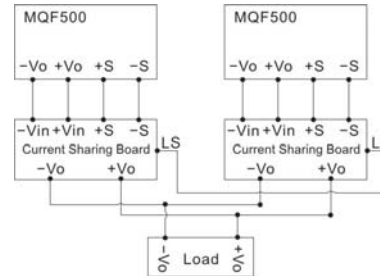
7. CAUTION: Double pole, neutral fusing. Disconnect mains before servicing.

(ATTENTION : 2 poles avec fusible sur le neutre. Deconnecter le secteur avant intervention.)

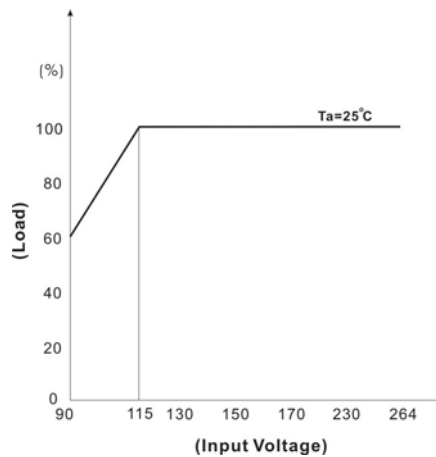
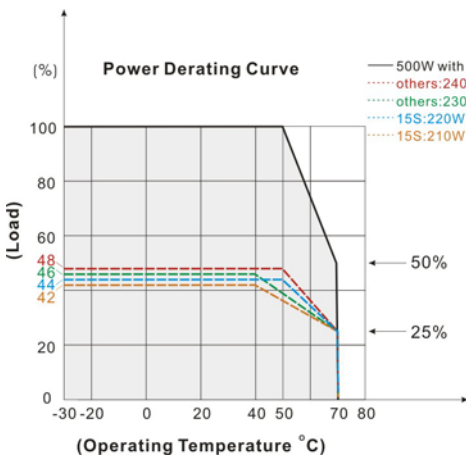
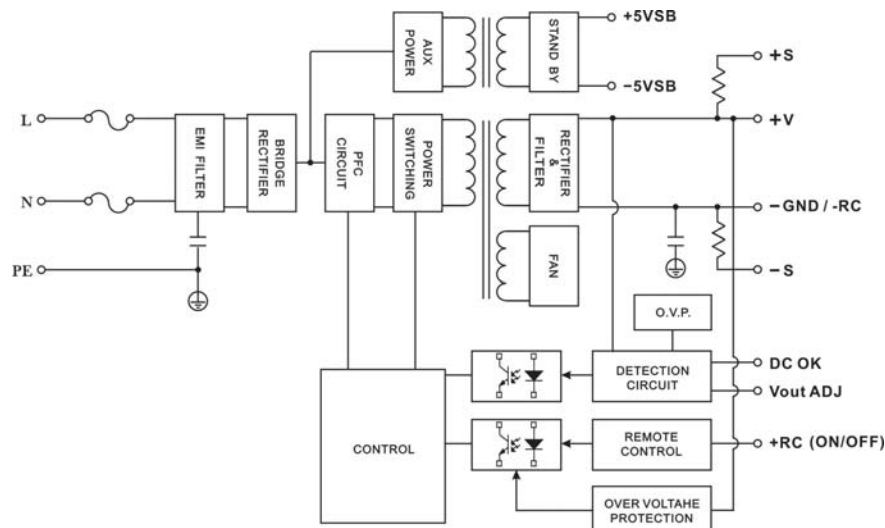
DERATING

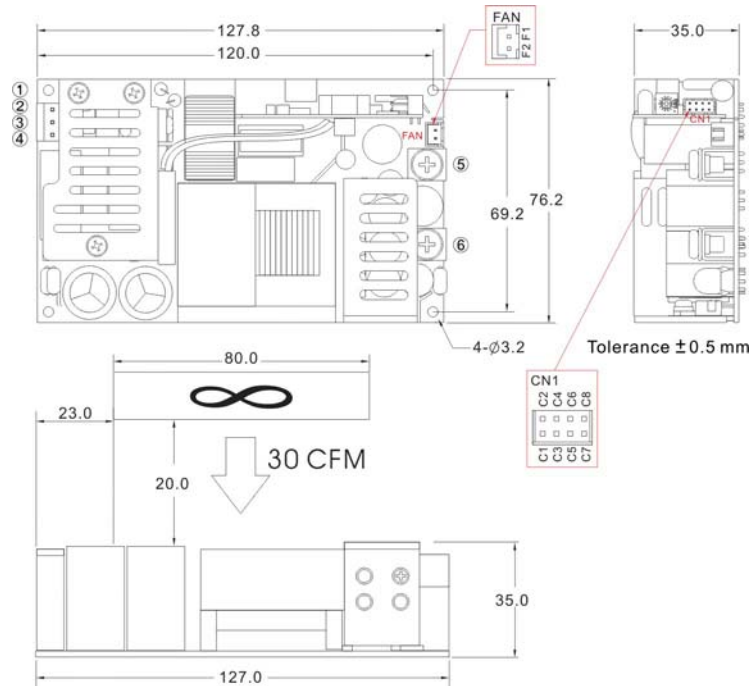
BLOCK DIAGRAM

MECHANICAL DIMENSIONS (Top View)
MQF5000

Brands		Alex		JST	
PIN#	Single	Mating Housing	Terminal	Mating Housing	Terminal
1	PE	—	—	—	—
2	AC IN (N)	9396-3	96T series	VHR-3N	SVH-41T-P1.1
3	NO PIN				
4	AC IN (L)				
5	+DC OUT	Terminal : M5 Pan HD screw in 2 positions Torque to 8 lbs-in(90 cNm) max.			
6	-DC OUT				

Connector Pin (CN1)					
Brands		Cherg Weei		JST	
PIN#	Single	Mating Housing	Terminal	Mating Housing	Terminal
C1	-5V SB	PHD-H20-2X4P	PHD-T20	PHDR-08VS	SPHD-001T-P0.5
C2	+5V SB				
C3	GND				
C4	DC-OK				
C5	-RC				
C6	+RC				
C7	-S				
C8	+S				

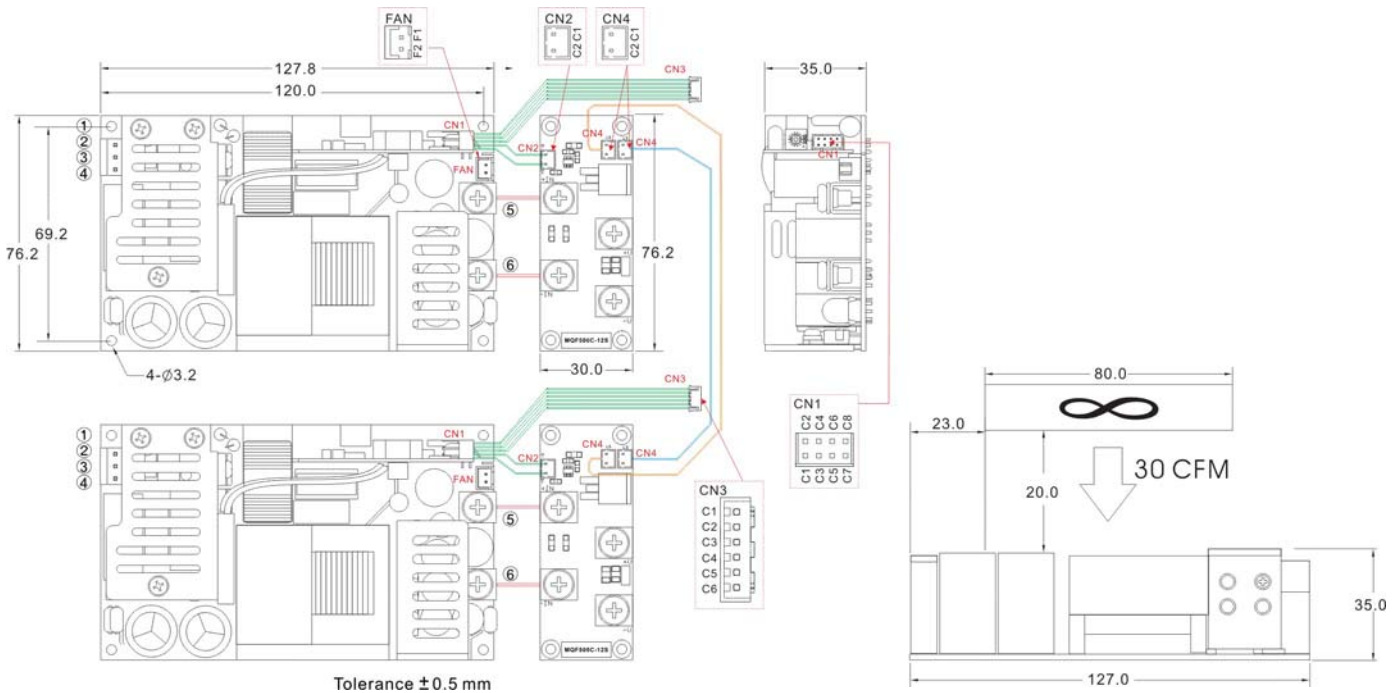
Connector Pin (FAN)					
Brands		Cherg Weei		JST	
PIN#	Single	Mating Housing	Terminal	Mating Housing	Terminal
F1	+12V	CX-H250-02	CX-T2501	XHP-2	SXH-002T-P0.6
F2	GND				

MECHANICAL DIMENSIONS (Top View)
MQF5000 with Current Share Function

Tolerance ± 0.5 mm

Brands		Alex		JST	
PIN#	Single	Mating Housing	Terminal	Mating Housing	Terminal
1	PE	—	—	—	—
2	AC IN (N)	9396-3	96T series	VHR-3N	SVH-41T-P1.1
3	NO PIN				
4	AC IN (L)				
5	+DC OUT	Terminal : M5 Pan HD screw in 2 positions Torque to 8 lbs-in(90 cNm) max.			
6	-DC OUT				

Connector Pin (CN1)					
Brands		Cherng Weei		JST	
PIN#	Single	Mating Housing	Terminal	Mating Housing	Terminal
C1	-5V SB	PHD-H20-2X4P	PHD-T20	PHDR-08VS	SPHD-001T-P0.5
C2	+5V SB				
C3	GND				
C4	DC-OK				
C5	-RC				
C6	+RC				
C7	-S				
C8	+S				

Connector Pin (FAN)					
Brands		Cherng Weei		JST	
PIN#	Single	Mating Housing	Terminal	Mating Housing	Terminal
F1	+12V	CX-H250-02	CX-T2501	XHP-2	SXH-002T-P0.6
F2	GND				

Connector Pin (CN2)					
Brands		Cherng Weei		JST	
PIN#	Single	Mating Housing	Terminal	Mating Housing	Terminal
C1	-S	CP-H20-02	CP-T20B	PHR-2	SPH-002T-P0.5L
C2	+S				

Mating Housing Pin (CN3)			
Brands		Cherng Weei	JST
PIN#	Single	Connector	Connector
C1	-5V SB	CP-W20-06	B6B-PH-K-S
C2	+5V SB		
C3	GND		
C4	DC-OK		
C5	-RC		
C6	+RC		

Connector Pin (CN4)					
Brands		Cherng Weei		JST	
PIN#	Single	Mating Housing	Terminal	Mating Housing	Terminal
C1	LS	CP-H20-02	CP-T20B	PHR-2	SPH-002T-P0.5L
C2	LS				

FUNCTION DESCRIPTION of CN1 and CN3 (CN3 without C7 and C8 pin)

Pin No.	Function	Description
C1	-5VSB	This pin connects to the negative terminal(-V). Return for DC-OK and -RC signal output.
C2	+5VSB	Stand by voltage output ground 4.2~5.5V, referenced to pin C1(-5VSB). The maximum load current is 1A with Fan, 0.4A without Fan..
C3	GND	This pin connects to the negative terminal(-V). Return for DC-OK and -RC signal output.
C4	DC OK	DC-OK Signal is a DC output, referenced to pin C3(DC-OK GND).
C5	-RC	This pin connects to the negative terminal(-V). Return for DC-OK and -RC signal output.
C6	+RC	Turns the output on and off by electrical or dry contact between pin C5 (-RC), Short: Power OFF, Open: Power ON. The input voltage must be less than 1V in order to disable VOUT and greater than 3.3V (up to 5V) to enable it.
C7	-S	Negative sensing. The -S signal should be connected to the negative terminal of the load. The -S and +S leads should be twisted in pair to minimize noise pick-up effect.
C8	+S	Positive sensing. The +S signal should be connected to the positive terminal of the load. The +S and -S leads should be twisted in pair to minimize noise pick-up effect.

FUNCTION MANUAL & APPLICATION NOTE
1. DC-OK Signal

Between DC-OK and GND	Output Status
3.7~6V	ON
0~1V	OFF

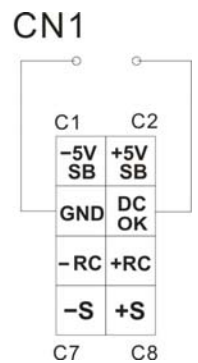
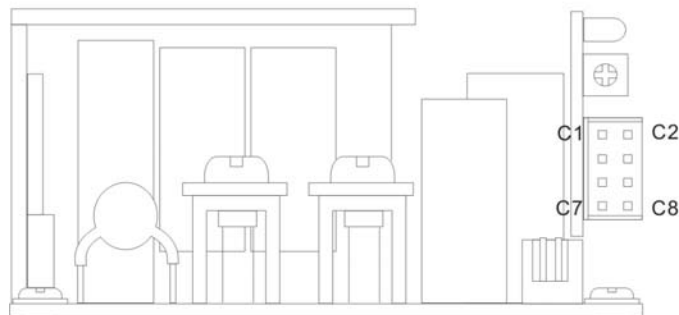

2. Remote Control

It can be turned ON/OFF by using the "Remote Control" function.

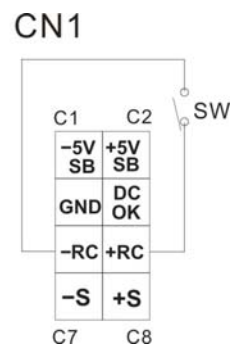
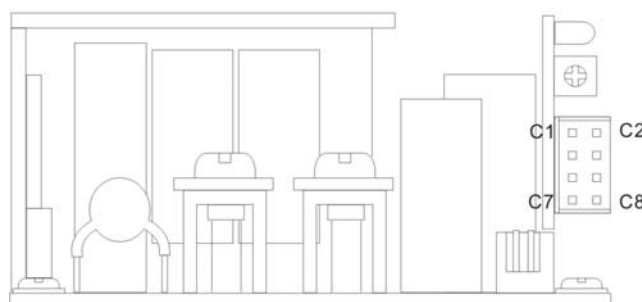
Between +RC and -RC	Output Status
SW ON (Short)	OFF
SW OFF (Open)	ON

2. +S and -S Sense

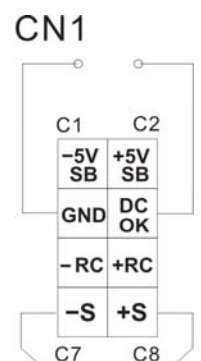
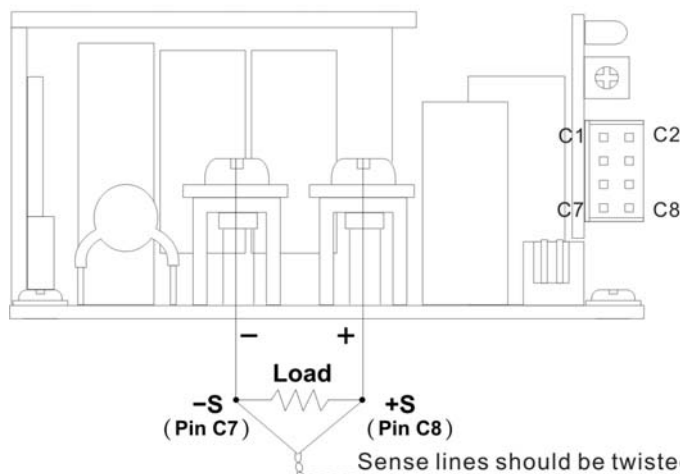
Shorter wiring to each unit is recommended, as well as twisting +S and -S in pairs, as shown below



KEY FEATURES

- U Bracket Medical Switching Power Supply
- Remote ON/OFF Function
- 200 Watt with Free Air Convection
- 500 Watt with 30CFM FAN Forced Air
- 4000VAC Input to Output 2MOPP Insulation
- Built-in 12V/0.3A Auxiliary Output
- Standby 5V@1A with Fan, @0.4A without Fan
- High Efficiency up to 93%
- With P.F.C. Function >0.94
- Current Share Function for Option (except for 15S)
- Suitable for BF Application with Appropriate System Consideration
- Ultra Compact Size: 5.5 x 3.25 x 1.6 Inches
- 3-Year Product Warranty

ELECTRICAL SPECIFICATIONS

All specifications valid at normal input voltage, full load and +25°C after warm-up time unless otherwise stated.

Model No.	MQF500U-12S	MQF500U-15S	MQF500U-24S	MQF500U-48S		
Max Output Wattage (W)	500 W (30CFM FAN)					
Max Output Wattage (W)	Others: 190 W (115 VAC) / 200 W (230 VAC)					
	15S: 170 W (115 VAC) / 180 W (230 VAC)					
Input	Voltage (Note 3)	90-264 VAC or 127-370 VDC				
	Frequency (Hz)	47-63 Hz				
	Current (Full load)	< 6.3 A max. (115 VAC) / <3.15 A max. (230 VAC)				
	Inrush Current (<2ms) (Cold Start)	< 40 A max. (115 VAC) / < 80 A max. (230 VAC)				
	Leakage Current	< 0.1mA / 264 VAC (Touch Current)				
	Power Factor (at 230 VAC)	PF>0.94 at Full Load				
Output	Voltage (V.DC.)	12V	15V	24V	48V	
	Voltage Accuracy	±2%				
	Voltage Adj. Range (V.DC)	±4% Output Voltage				
	Current (with 30CFM FAN) (A) max	41.5	33.3	20.8	10.41	
	Current (Free air Convection) (A) max	at 115 VAC	15.83	11.33	7.91	3.96
		at 230 VAC	16.6	12	8.33	4.17
	Line Regulation (115-264 VAC)	±0.5%				
	Load Regulation (10-100%) (typ.)	±1%				
	Minimum Load	3%				
	Maximum Capacitive Load	5,000µF	3,750µF	2,500µF	1,250µF	
	Ripple & Noise (typ.)	160mV	160mV	240mV	480mV	
	Efficiency (at 230 VAC)	90.5%	90.5%	92%	93%	
	Hold-up Time (at 115 VAC)	8 ms min.				
Protection	Over Power Protection	Auto recovery				
	Over Voltage Protection	Auto recovery				
	Over Temperature Protection	Auto recovery				
	Short Circuit Protection	Protection level 1 (nominal) : Continuous, Auto recovery				
Protection level 2 (instantaneous high current) : Latch						
Isolation	Input-Output (V.AC)	4000VAC or 5656VDC				
	Input-PE (V.AC)	2000V				
	Output-PE (V.AC)	1500V				

ELECTRICAL SPECIFICATIONS

All specifications valid at normal input voltage, full load and +25°C after warm-up time unless otherwise stated.

Model No.	MQF500U-12S	MQF500U-15S	MQF500U-24S	MQF500U-48S
Environment	Operating Temperature	-30°C...+70°C (with derating)		
	Storage Temperature	-35°C...+85°C		
	Temperature Coefficient	±0.03%/°C (0~50°C)		
		±0.06%/°C (-30~0°C)		
	Altitude During Operation	5000m		
	Humidity	95% RH		
	Atmospheric Pressure	56 kPa to 106 kPa		
	MTBF	>160,000 h @ 25°C (MIL-HDBK-217F)		
	Vibration	IEC60068-2-6 (10~500Hz, 2G 10min./1cycle, 60min. each along X, Y, Z axes)		
Shock	IEC60068-2-27			
Physical	Dimension s(L x W x H)	5.5 x 3.25 x 1.6 Inches (139.7 x 82.55 x 40.6 mm) Tolerance ±0.5 mm		
	Weight	580 g		
	Cooling Method	Free convection / 30 CFM FAN		
Safety	Approval	12S/24S/48S: UL / IEC / EN 60601 3.1 st Edition (2 x MOPP) , UL / IEC / EN 60950 AM2, UL / IEC / EN 62368		
	Approval / Meet	15S: UL / IEC / EN 60601 3.1 st Edition (2 x MOPP) , UL / IEC / EN 60950 AM2 (meet), UL / IEC / EN 62368 (meet)		
EMC	Conducted and Radiated EMI	EN55011 / conducted class B, Radiated Class A		
	EMS	EN60601-1-2 4th edition		

NOTE

1. Ripple & Noise are measured at 20MHz of bandwidth with ceramic 0.1uF & chemi-con KY 47uF parallel capacitor.

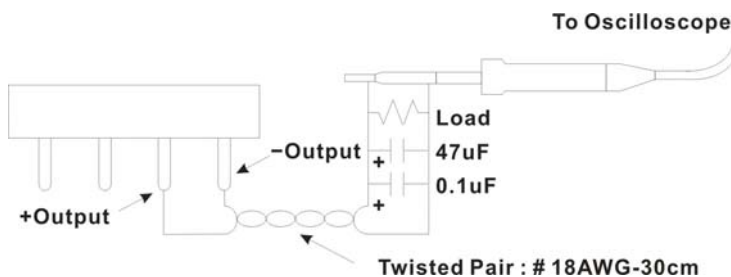

A 30cm twisted pair of no.18 AWG copper wire is connected to a 47uF and 0.1uF capacitor of proper polarity and voltage rating. The oscilloscope probe ground led should connect right to the ground ring of the probe and be as short as possible. The oscilloscope bandwidth should be at 20MHz and connected to AC ground.

2. Hold-up Time measured at 90% Vout.
3. Please check the derating curve for more details.
4. Main Vout >3% Load, 12V (Aux) / 0.3A., 12V (Aux) need 0.1A Minimum Load, Auxiliary voltage output ground 10.2~13.3V
5. Strongly recommend to conduct this test with DC Voltage. If customer wishes to test with AC Voltage, please disconnect all Y-Capacitors from Arch power supply.

NOTE

6. Current Share Board (Optional):

- (a.)The output voltage difference of each parallel single element should be less than 0.2V.
- (b.)Output power at parallel operation = rated power per unit x number of unit x 90%
- (c.)Connect in parallel no more than 2 units. Please contact ARCH for advice if more than 2 is needed.
- (d.)Minimum Load Should be 15%.

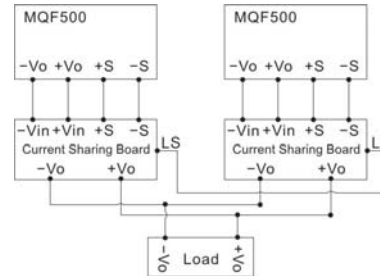

7. CAUTION: Double pole, neutral fusing. Disconnect mains before servicing.

(ATTENTION : 2 poles avec fusible sur le neutre. Deconnecter le secteur avant intervention.)

DERATING

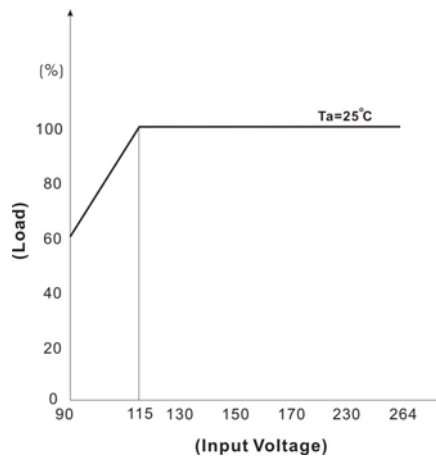
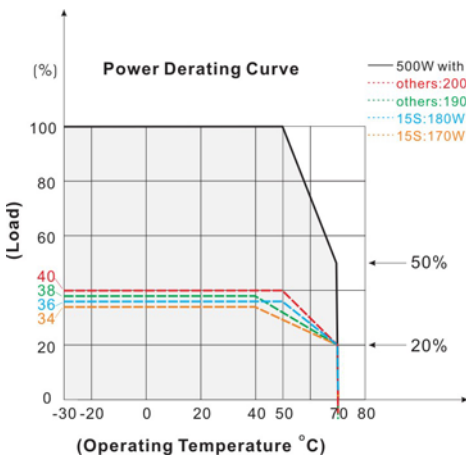

BLOCK DIAGRAM

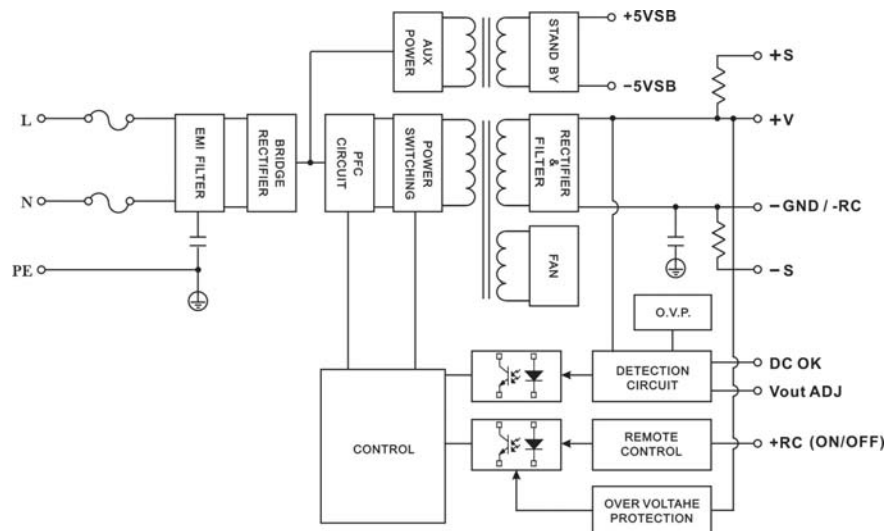

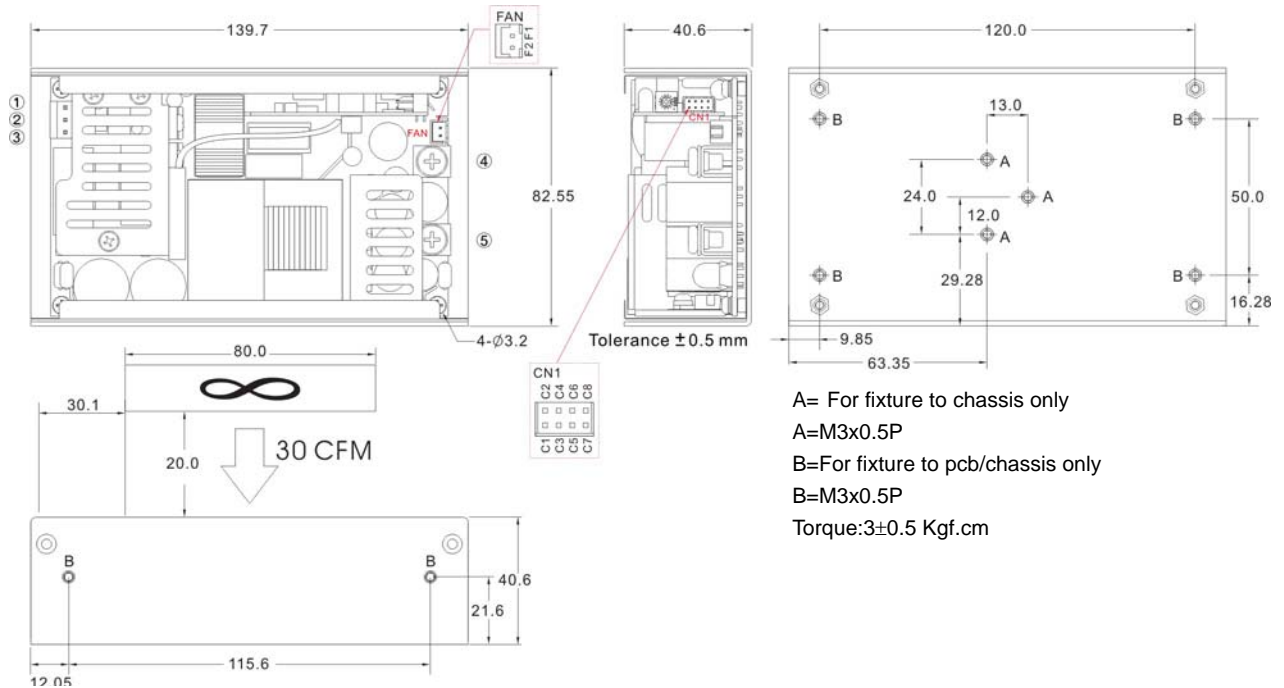
MECHANICAL DIMENSIONS (Top View)
MQF500U

Brands		Alex		JST	
PIN#	Single	Mating Housing	Terminal	Mating Housing	Terminal
A,B	PE	—	—	—	—
1	AC IN (N)	9396-3	96T series	VHR-3N	SVH-41T-P1.1
2	NO PIN				
3	AC IN (L)				
4	+DC OUT	Terminal : M5 Pan HD screw in 2 positions Torque to 8 lbs-in(90 cNm) max.			
5	-DC OUT				

ASSEMBLY INSTRUCTIONS

*U Case T=1.5mm

Customer is advised to screw into the threads no more than 1.5mm

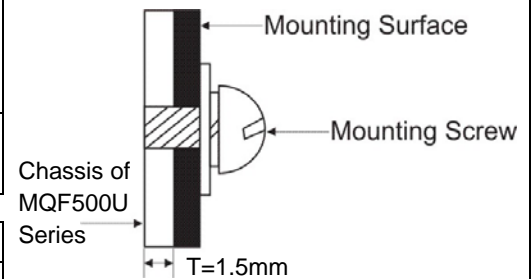

Connector Pin (CN1)					
Brands		Cherng Weei		JST	
PIN#	Single	Mating Housing	Terminal	Mating Housing	Terminal
C1	-5V SB	PHD-H20-2X4P	PHD-T20	PHDR-08VS	SPHD-001T-P0.5
C2	+5V SB				
C3	GND				
C4	DC-OK				
C5	-RC				
C6	+RC				
C7	-S				
C8	+S				

Connector Pin (FAN)					
Brands		Cherng Weei		JST	
PIN#	Single	Mating Housing	Terminal	Mating Housing	Terminal
F1	+12V	CX-H250-02	CX-T2501	XHP-2	SXH-002T-P0.6
F2	GND				

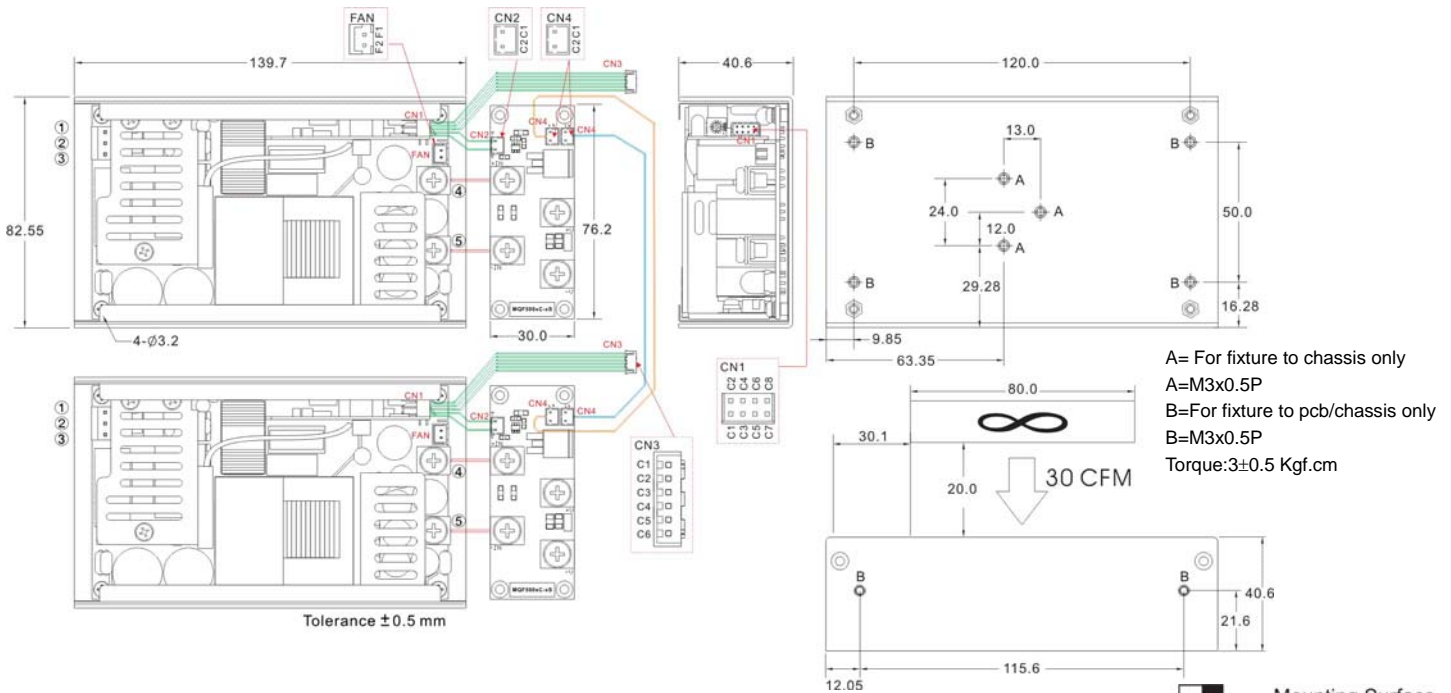
MECHANICAL DIMENSIONS (Top View)
MQF500U with Current Share Function

A= For fixture to chassis only
 A=M3x0.5P
 B=For fixture to pcb/chassis only
 B=M3x0.5P
 Torque:3±0.5 Kgf.cm

Brands		Alex		JST	
PIN#	Single	Mating Housing	Terminal	Mating Housing	Terminal
A,B	PE	—	—	—	—
1	AC IN (N)	9396-3	96T series	VHR-3N	SVH-41T-P1.1
2	NO PIN				
3	AC IN (L)				
4	+DC OUT	Terminal: M5 Pan HD screw in 2 positions Torque to 8 lbs-in(90 cNm) max.			
5	-DC OUT				

Connector Pin (CN1)					
Brands		Cherng Weei		JST	
PIN#	Single	Mating Housing	Terminal	Mating Housing	Terminal
C1	-5V SB	PHD-H20-2X4P	PHD-T20	PHDR-08VS	SPHD-001T-P0.5
C2	+5V SB				
C3	GND				
C4	DC-OK				
C5	-RC				
C6	+RC				
C7	-S				
C8	+S				

Connector Pin (FAN)					
Brands		Cherng Weei		JST	
PIN#	Single	Mating Housing	Terminal	Mating Housing	Terminal
F1	+12V	CX-H250-02	CX-T2501	XHP-2	SXH-002T-P0.6
F2	GND				

ASSEMBLY INSTRUCTIONS

*U Case T=1.5mm

Customer is advised to screw into the threads no more than 1.5mm

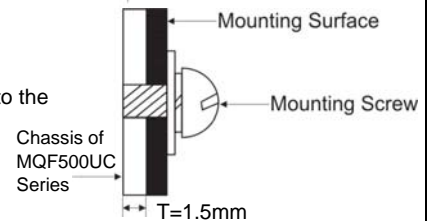

Connector Pin (CN2)					
Brands		Cherng Weei		JST	
PIN#	Single	Mating Housing	Terminal	Mating Housing	Terminal
C1	-S	CP-H20-02	CP-T20B	PHR-2	SPH-002T-P0.5L
C2	+S				

Mating Housing Pin (CN3)			
Brands		Cherng Weei	JST
PIN#	Single	Connector	Connector
C1	-5V SB	CP-W20-06	B6B-PH-K-S
C2	+5V SB		
C3	GND		
C4	DC-OK		
C5	-RC		
C6	+RC		

Connector Pin (CN4)					
Brands		Cherng Weei		JST	
PIN#	Single	Mating Housing	Terminal	Mating Housing	Terminal
C1	LS	CP-H20-02	CP-T20B	PHR-2	SPH-002T-P0.5L
C2	LS				

FUNCTION DESCRIPTION of CN1 and CN3 (CN3 without C7 and C8 pin)

Pin No.	Function	Description
C1	-5VSB	This pin connects to the negative terminal(-V). Return for DC-OK and -RC signal output.
C2	+5VSB	Stand by voltage output ground 4.2~5.5V, referenced to pin C1(-5VSB). The maximum load current is 1A with Fan, 0.4A without Fan..
C3	GND	This pin connects to the negative terminal(-V). Return for DC-OK and -RC signal output.
C4	DC OK	DC-OK Signal is a DC output, referenced to pin C3(DC-OK GND).
C5	-RC	This pin connects to the negative terminal(-V). Return for DC-OK and -RC signal output.
C6	+RC	Turns the output on and off by electrical or dry contact between pin C5 (-RC), Short: Power OFF, Open: Power ON. The input voltage must be less than 1V in order to disable VOUT and greater than 3.3V (up to 5V) to enable it.
C7	-S	Negative sensing. The -S signal should be connected to the negative terminal of the load. The -S and +S leads should be twisted in pair to minimize noise pick-up effect.
C8	+S	Positive sensing. The +S signal should be connected to the positive terminal of the load. The +S and -S leads should be twisted in pair to minimize noise pick-up effect.

FUNCTION MANUAL & APPLICATION NOTE
1. DC-OK Signal

Between DC-OK and GND	Output Status
3.7~6V	ON
0~1V	OFF

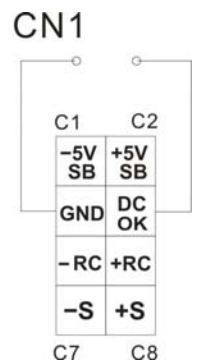
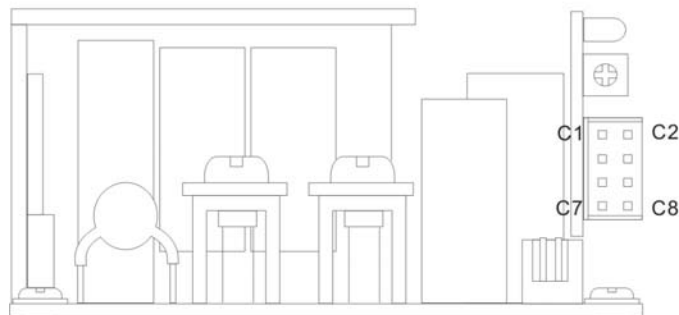

2. Remote Control

It can be turned ON/OFF by using the "Remote Control" function.

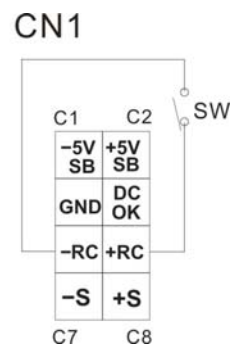
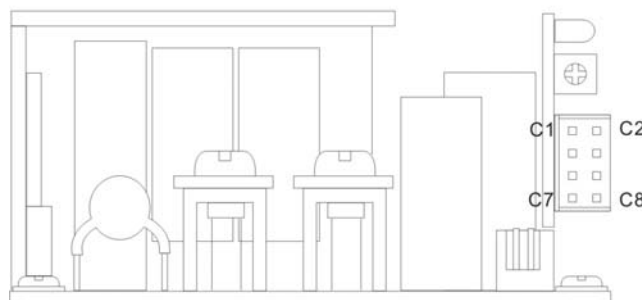
Between +RC and -RC	Output Status
SW ON (Short)	OFF
SW OFF (Open)	ON

2. +S and -S Sense

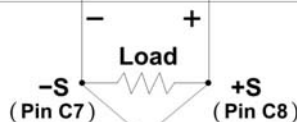
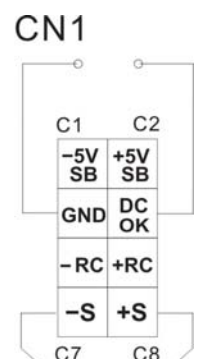
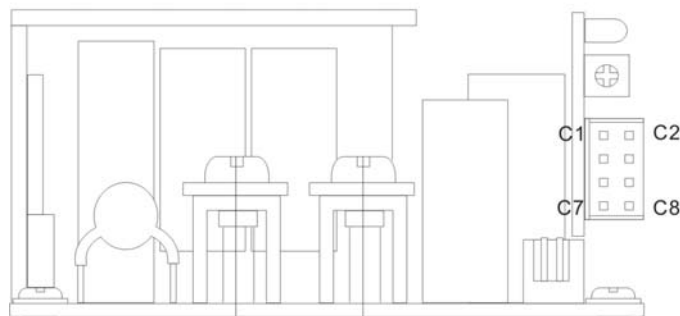
Shorter wiring to each unit is recommended, as well as twisting +S and -S in pairs, as shown below



Sense lines should be twisted in pairs