

KEY FEATURES

- Universal Input 90-264Vac
- High Efficiency up to 91.5%
- Safety Approval to UL / IEC / EN 62368-1
- -30°C to +70°C Wide Range Operation Temperature
- Operating Altitude 5000M
- Active PFC Function
- I/O Isolation 4000VAC
- Standby 5V@1A
- 3-Year Product Warranty



ELECTRICAL SPECIFICATIONS

All specifications valid at normal input voltage, full load and +25°C after warm-up time unless otherwise stated.

Model No.	ARF500E-12S	ARF500E-24S	ARF500E-48S	
Max Output Wattage (W)	500 W			
Input	Voltage (Note 3)	90-264 VAC or 127-370 VDC		
	Frequency (Hz)	47-63 Hz		
	Current (Full load)	<6.3 A max. (115 VAC) / <3.15 A max. (230 VAC)		
	Inrush Current (<2ms) (Clod Start)	< 40 A max. (115 VAC) / < 80 A max. (230 VAC)		
	Leakage Current	< 1.5mA / 264 VAC (Touch Current)		
	Power Factor (at 230 VAC)	PF>0.94 at Full Load		
Output	Voltage (V.DC.)	12V	24V	48V
	Voltage Adj Range (V.DC.)	±5% Output Voltage		
	Voltage Accuracy	±2%		
	Current (A) (max.)	41.5	20.8	10.41
	Line Regulation (100-264 VAC)	±1%		
	Load Regulation (10-100%) (typ.)	±1%		
	Minimum Load	1%		
	Maximum Capacitive Load	5,000µF	2,500µF	1,250µF
	Ripple & Noise (typ.) (Note 1)	160mV	240mV	480mV
	Efficiency (at 230VAC)	90%	90.5%	91.5%
	Hold-up Time (at 115 VAC) (Note 2)	8 ms min.		
Protection	Over Power Protection	Auto recovery		
	Over Voltage Protection	Auto recovery		
	Over Temperature Protection	Auto recovery		
	Short Circuit Protection	Protection level 1 (nominal) : Continuous, Auto recovery Protection level 2 (instantaneous high current) : Latch		
Isolation	Input-Output (Note 5)	4000VAC or 5656VDC		
	Input-PE (Note 5)	2000VAC or 2828VDC		
	Output-PE (Note 5)	1500VAC or 2121VDC		
Environment	Operating Temperature	-30°C...+70°C (with derating)		
	Storage Temperature	-30°C...+85°C		
	Temperature Coefficient	±0.03%/°C (0~50°C)		
		±0.06%/°C (-30~0°C)		
	Altitude During Operation	5000m		
	Humidity	95% RH		
	MTBF	>160,000 h @ 25°C (MIL-HDBK-217F)		
	Vibration	IEC60068-2-6 (10~500Hz, 2G 10min./1cycle, 60min. each along X, Y, Z axes)		
Shock	IEC60068-2-27			

ELECTRICAL SPECIFICATIONS

All specifications valid at normal input voltage, full load and +25°C after warm-up time unless otherwise stated.

Model No.		ARF500E-12S	ARF500E-24S	ARF500E-48S
Physical	Dimensions (L x W x H)	5.12 x 3.27 x 2.45 Inches (130.0 x 83.0 x 62.3 mm) Tolerance ± 0.5 mm		
	Weight	710 g		
Safety	Approval	UL / IEC / EN 62368-1		
Parameter	Standards & Level	Performance		
EMI	Conducted	EN55032		Class B
	Radiated	EN55032		Class A
EMS	EN 55035			A
	ESD	IEC 61000-4-2 Air ± 8 KV , Contact ± 4 KV		A
	RS	IEC 61000-4-3 3V/m		A
	EFT/B	IEC 61000-4-4 ± 1 KV		A
	Surge	IEC 61000-4-5 ± 1 KV		A
	CS	IEC 61000-4-6 3Vrms		A
	PFMF	IEC 61000-4-8 1A/m		A
	Dips	IEC 61000-4-11 70% 500ms		B
	Interruptions	IEC 61000-4-11 <5% 5000ms		B

NOTE

- Ripple & Noise are measured at 20MHz of bandwidth with ceramic 0.1uF & chemi-con KY 47uF parallel capacitor.

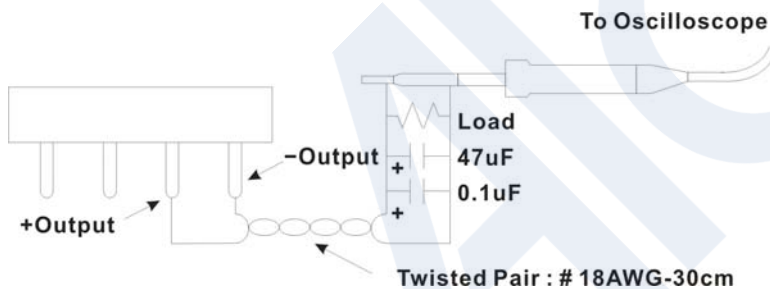

A 30cm twisted pair of no.18 AWG copper wire is connected to a 47uF and 0.1uF capacitor of proper polarity and voltage rating. The oscilloscope probe ground led should connect right to the ground ring of the probe and be as short as possible. The oscilloscope bandwidth should be at 20MHz and connected to AC ground.

- Hold-up Time measured at 90% Vout.
- Please check the derating curve for more details.
- Fan output voltage will be between 10.2~13.3V, when the main output is greater than 3% of the max. load, and fan's terminal block output current is higher than 0.1A (min.)
- Strongly recommend to conduct this test with DC Voltage. If customer wishes to test with AC Voltage, please disconnect all Y-Capacitors from Arch power supply.
- CAUTION: Double pole, neutral fusing. Disconnect mains before servicing.
(ATTENTION : 2 poles avec fusible sur le neutre. Deconnecter le secteur avant intervention.)

DERATING

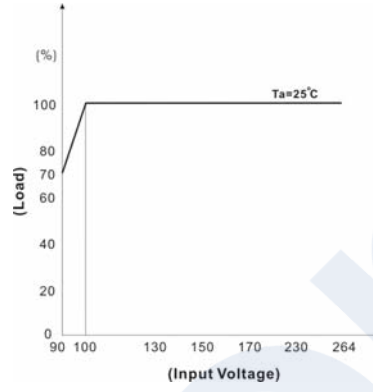
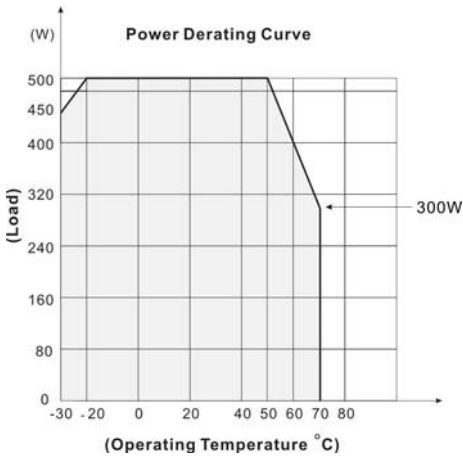

If input voltage is lower than 100VAC, please refer to the output derating V.S. input voltage curve for details

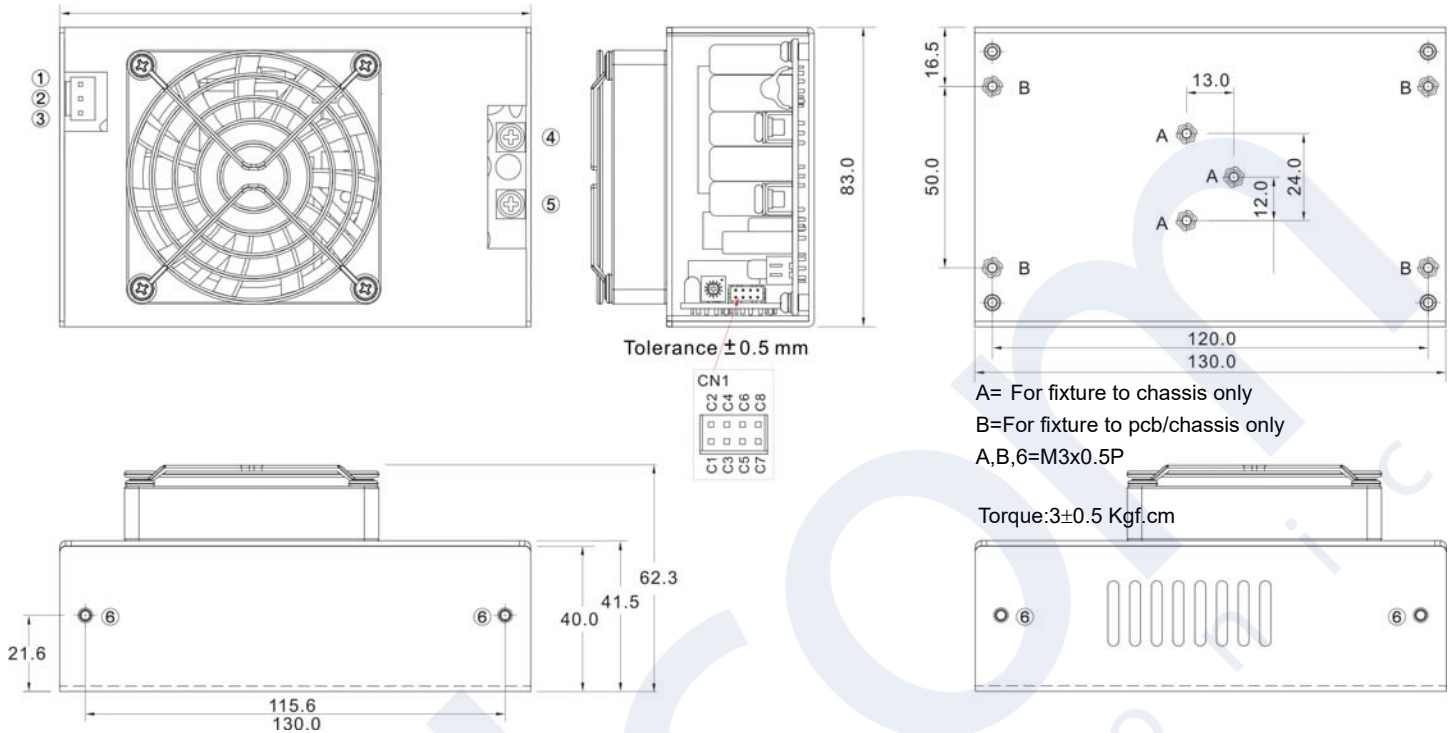
MECHANICAL DIMENSIONS (Top View)

A= For fixture to chassis only
 B=For fixture to pcb/chassis only
 A,B,6=M3x0.5P

Torque:3±0.5 Kgf.cm

Brands		Alex		JST	
PIN#	Single	Mating Housing	Terminal	Mating Housing	Terminal
6,B	PE	—	—	—	—
1	AC IN (N)	9396-3	96T series	VHR-3N	SVH-41T-P1.1
2	NO PIN				
3	AC IN (L)				
4	+DC OUT	Terminal : M3.5 Pan HD screw in 2 positions Torque to 8 lbs-in(90 cNm) max.			
5	-DC OUT				

ASSEMBLY INSTRUCTIONS

*U Case T=1.5mm
 Customer is advised to screw into the threads no more than 1.5mm

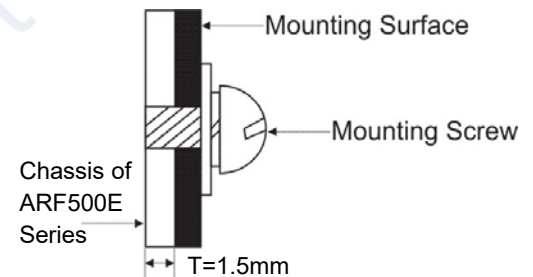

Connector Pin (CN1)					
Brands		Cherng Weei		JST	
PIN#	Single	Mating Housing	Terminal	Mating Housing	Terminal
C1	-5V SB	PHD-H20-2X4P	PHD-T20	PHDR-08VS	SPHD-001T-P0.5
C2	+5V SB				
C3	GND				
C4	DC-OK				
C5	-RC				
C6	+RC				
C7	-S				
C8	+S				

Connector Pin (FAN) (Note 4)					
Brands		Alex		JST	
PIN#	Single	Mating Housing	Terminal	Mating Housing	Terminal
F1	+12V	8821-2	8820T	XHP-2	SXH-002T-P0.6
F2	GND				

FUNCTION DESCRIPTION of CN1

Pin No.	Function	Description
C1	-5VSB	This pin connects to the negative terminal(-V). Return for DC-OK and -RC signal output.
C2	+5VSB	Stand by voltage output ground 4.1~5.5V, referenced to pin C1(-5VSB). The maximum load current is 1A with Fan
C3	GND	This pin connects to the negative terminal(-V). Return for DC-OK and -RC signal output.
C4	DC OK	DC-OK Signal is a DC output, referenced to pin C3(DC-OK GND).
C5	-RC	This pin connects to the negative terminal(-V). Return for DC-OK and -RC signal output.
C6	+RC	Turns the output on and off by electrical or dry contact between pin C5 (-RC), Short: Power OFF, Open: Power ON. The input voltage must be less than 1V in order to disable VOUT and greater than 3.3V (up to 5V) to enable it.
C7	-S	Negative sensing. The -S signal should be connected to the negative terminal of the load. The -S and +S leads should be twisted in pair to minimize noise pick-up effect.
C8	+S	Positive sensing. The +S signal should be connected to the positive terminal of the load. The +S and -S leads should be twisted in pair to minimize noise pick-up effect.

FUNCTION MANUAL & APPLICATION NOTE
1. DC-OK Signal

Between DC-OK and GND	Output Status
3.7~6V	ON
0~1V	OFF

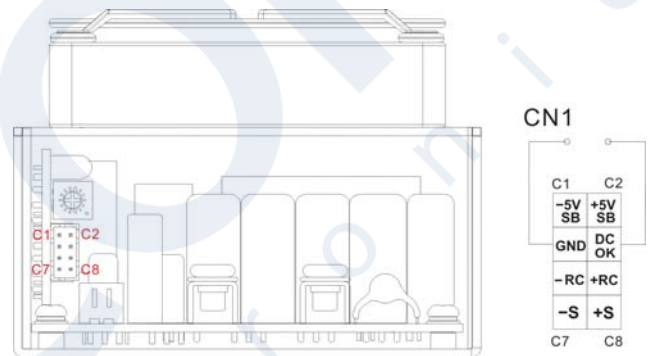
2. Remote Control

It can be turned ON/OFF by using the "Remote Control" function.

Between +RC and -RC	Output Status
SW ON (Short)	OFF
SW OFF (Open)	ON

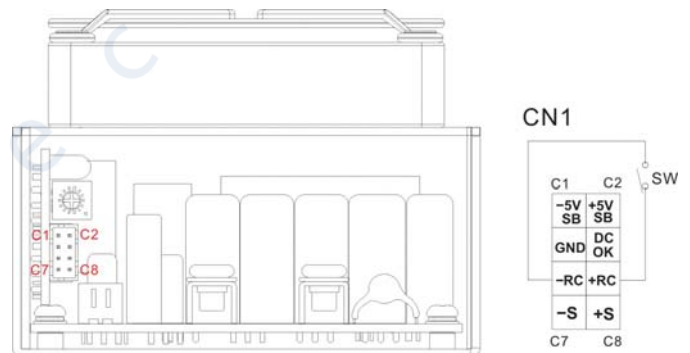
2. +S and -S Sense

Shorter wiring to each unit is recommended, as well as twisting +S and -S in pairs, as shown below

