

Features

- TPS14P50: 12-V E-fuse
 - 15-V Over-Voltage Clamp
- TPS05P50: 5-V E-fuse
 - 6.1-V Over-Voltage Clamp
- 27-mΩ Low Turn-On Resistance
- 5-A Maximum Continuous Current
 - 2-A to 5-A Adjustable Current Limit
 - ±15% Adjustable Current Limit Accuracy
- Adjustable Output Voltage Slew Rate
- Adjustable Undervoltage Lock Out
- Integrated Inrush Control
- Protection:
 - Over-Current Protection
 - Short-to-Ground Protection
 - Over-Temperature Protection
- Temperature Range: -40°C to 125°C
- Package Options:
 - DFN3X3-10

Applications

- Hotswap Protection
- HDD and SSD Driver Card
- PCIe Cards
- Server Fan Power Supply

Description

The TPS14P50 and TPS05P50 are 5-A e-fuse switches with voltage clamp and current limit protection functions integrated. The TPS14P50 integrates a 15-V over-voltage clamp and the TPS05P50 integrates a 6.1-V over-voltage clamp. The over-voltage clamp function can limit the output voltage during the input voltage surge to protect the load from damage. The TPS14P50 and TPS05P50 integrate an adjustable current limit function. The current limit level can be set from 2 A to 5 A by connecting an external resistor at the ILIM pin and the current limit accuracy is ±15% typically.

To limit the inrush current and meet the output voltage smoothly ramp up requirement, the TPS14P50 and TPS05P50 integrate a soft-start function, which can be adjusted by a capacitor connected at the dVdt pin.

Both of the TPS14P50 and the TPS05P50 products are guaranteed to operate in the ambient temperature range from -40°C to +125°C. Additionally, both products provide the thermal-enhanced DFN3X3-10 package to enable sustained operation despite significant dissipation across the device.

Typical Application Circuit

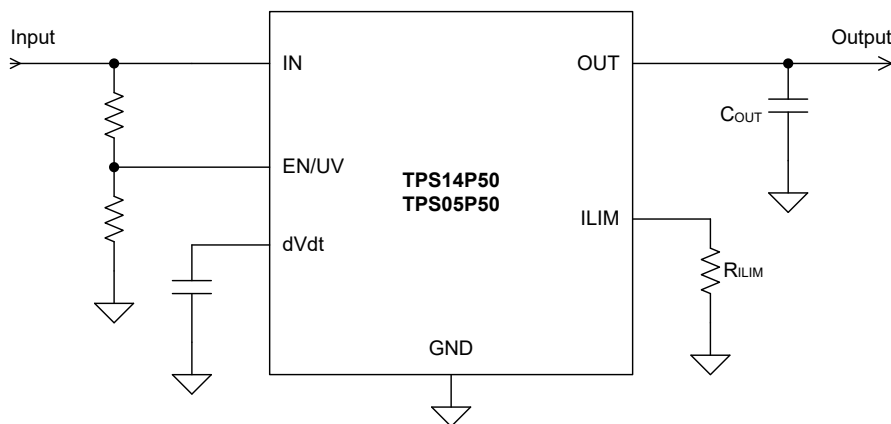

Table of Contents

Features	1
Applications	1
Description	1
Typical Application Circuit	1
Product Family Table	3
Revision History	3
Pin Configuration and Functions	4
Specifications	5
Absolute Maximum Ratings ⁽¹⁾	5
ESD, Electrostatic Discharge Protection.....	5
Recommended Operating Conditions.....	5
Thermal Information.....	6
Electrical Characteristics.....	7
Typical Performance Characteristics.....	9
Detailed Description	14
Overview.....	14
Functional Block Diagram.....	14
Feature Description.....	14
Application and Implementation	17
Application Information	17
Typical Application.....	17
Layout	19
Layout Guideline.....	19
Layout Example.....	19
Tape and Reel Information	20
Package Outline Dimensions	22
DFN3X3-10-A.....	22
Order Information	23
IMPORTANT NOTICE AND DISCLAIMER	24

Product Family Table

Order Number	Over-Voltage Clamp (V)	Fault Response	Package
TPS14P50A-DF8R	15	Auto Retry	DFN3X3-10
TPS14P50B-DF8R	15	Latched	DFN3X3-10
TPS05P50A-DF8R	6.1	Auto Retry	DFN3X3-10
TPS05P50B-DF8R	6.1	Latched	DFN3X3-10

Revision History

Revision	Notes
Rev.Pre.0	Preliminary datasheet.
Rev.Pre.1	Added Typical Performance Characteristics , Functional Block Diagram , and Feature Description .
Rev.A.0	Initial Released.

Pin Configuration and Functions

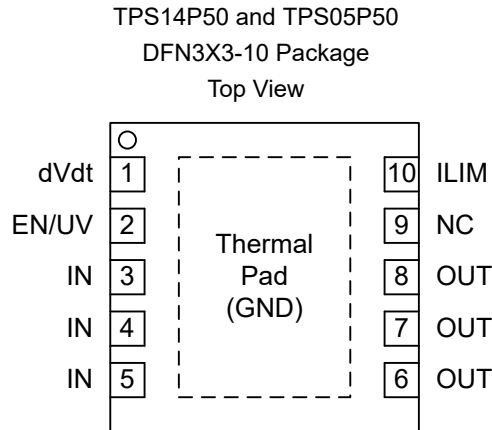

Table 1. Pin Functions: TPS14P50 and TPS05P50

Pin No.	Pin Name	I/O	Description
dVdt	1	O	Output voltage ramp up slew rate control pin. Connect a capacitor from this pin to ground to set the output voltage ramp-up slew rate.
EN/UV	2	I	Device enable and UVLO set pin. Pull this pin to HIGH or Low to enable or disable the device output. Connect a resistor divider to set the UVLO threshold.
GND	Thermal Pad	-	Ground reference pin. MUST connect this pin the to the PCB ground plane directly.
ILIM	5	O	Output current limit adjust pin. Connect a resistor from this pin to the ground to set the current limit threshold.
IN	3, 4, 5	I	Input power supply voltage pin. Suggest connecting a 0.1 μF or greater ceramic capacitor from IN to GND closely by the device.
NC	9	-	No internal connection.
OUT	6, 7, 8	O	Output voltage pin. Output capacitor is not required. 3PEAK suggests adding a 1 μF or greater ceramic capacitor from this pin to ground to improve transient performance.

Specifications

Absolute Maximum Ratings ⁽¹⁾

Parameter		Min	Max	Unit
IN	Input Supply Voltage	-0.3	20	V
IN	Transient Input Supply Voltage (< 1 ms)	-0.3	22	V
OUT	Output Voltage	-0.3	20	V
OUT	Transient Output Voltage (< 1 μ s)	-1.2		V
dVdt		-0.3	7	V
EN/UV		-0.3	7	V
ILIM		-0.3	7	V
T _J	Junction Temperature Range	-40	150	°C
T _{STG}	Storage Temperature Range	-65	150	°C
T _L	Lead Temperature (Soldering 10 sec)		260	°C

(1) Stresses beyond those listed under Absolute Maximum Ratings may cause permanent damage to the device. Exposure to any Absolute Maximum Rating condition for extended periods may affect device reliability and lifetime.

(2) All voltage values are with respect to GND.

(3) Not subject to production test, specified by design.

ESD, Electrostatic Discharge Protection

Parameter		Condition	Minimum Level	Unit
HBM	Human Body Model ESD	ANSI/ESDA/JEDEC JS-001 ⁽¹⁾	± 2	kV
CDM	Charged Device Model ESD	ANSI/ESDA/JEDEC JS-002 ⁽²⁾	± 1	kV

(1) JEDEC document JEP155 states that 500-V HBM allows safe manufacturing with a standard ESD control process.

(2) JEDEC document JEP157 states that 250-V CDM allows safe manufacturing with a standard ESD control process.

Recommended Operating Conditions

Parameter		Min	Typ	Max	Unit
V _{IN}	TPS14P50	4.5	12	14	V
V _{IN}	TPS05P50	4.5	5	5.5	V
V _{dVdt}		0		6	V
C _{dVdt}	Output Capacitor ESR Requirements		1	1000	nF
V _{EN/UV}		0		6	V
V _{ILIM}		0		3	V
R _{ILIM}	Current Limit Resistor	10		162	k Ω
I _{OUT}	Continuous Output Current	1		5	A
C _{OUT}	Output Capacitor Requirements	0.1	1	1000	μ F

5-A E-fuse Protection Switches with Inrush Control

Parameter		Min	Typ	Max	Unit
T _J	Junction Temperature	-40		125	°C

Thermal Information

Package Type	θ_{JA}	θ_{JB}	θ_{JC}	Unit
DFN3X3-10	46.5	14.4	47.6	°C/W

5-A E-fuse Protection Switches with Inrush Control
Electrical Characteristics

All test conditions: $V_{IN} = 12\text{ V}$ for TPS14P50, $V_{IN} = 5\text{ V}$ for TPS05P50, $V_{EN/UV} = 2\text{ V}$, $R_{LIM} = 100\text{ k}\Omega$, $C_{dVdt} = \text{OPEN}$, $T_J = -40^\circ\text{C}$ to 125°C , unless otherwise noted.

Parameter		Conditions	Min	Typ	Max	Unit
Supply Voltage and Current						
UVLO	V_{IN} Under-Voltage Lockout Threshold	V_{IN} rising, $V_{EN/UV} = 2\text{ V}$, $I_{OUT} = 10\text{ mA}$	4.15	4.3	4.49	V
	Hysteresis			350		mV
I_Q	Quiescent Current, TPS14P50	$V_{EN/UV} = 2\text{ V}$, $I_{OUT} = 0\text{ mA}$		0.5	0.8	mA
	Quiescent Current, TPS05P50	$V_{EN/UV} = 2\text{ V}$, $I_{OUT} = 0\text{ mA}$		0.5	0.8	mA
I_{SD}	Shutdown Current	$V_{EN/UV} = 0\text{ V}$		0.1	0.2	mA
V_{OVC}	Over-Voltage Clamp	$V_{IN} > 16.5\text{ V}$, $I_{OUT} = 10\text{ mA}$, TPS14P50	13.8	15	16.5	V
		$V_{IN} > 5.5\text{ V}$, $I_{OUT} = 10\text{ mA}$, TPS05P50	5.5	6.1	6.75	V
Enable/UVLO Voltage and Current						
$V_{IH,EN/UV}$	EN/UV Logic Input High (Enable)		1.37	1.4	1.50	V
$V_{IL,EN/UV}$	EN/UV Logic Input Low (Disable)		1.32	1.35	1.40	V
$I_{EN/UV}$	EN/UV Pin Leakage Current	$V_{EN} = 0\text{ V}$ to 5 V	-0.1		0.1	μA
dVdt Output Ramp-Up Control						
I_{dVdt}	dVdt Charging Current	Force $V_{dVdt} = 0\text{ V}$		220		nA
R_{dVdt}	dVdt Discharging Resistance	$V_{EN/UV} = 0\text{ V}$, force 10 mA to dVdt	90	130	170	Ω
V_{dVdt}	dVdt Maximum Capacitor Voltage			1.2		V
Output Power MOSFET						
R_{ON}	Turn-On Resistance	$T_J = 25^\circ\text{C}$	24	27	31	m Ω
		$T_J = -40$ to 125°C	15	27	40	m Ω
$I_{OUT-OFF}$	OUT Bias Current in OFF Status	$V_{EN/UV} = 0\text{ V}$, $V_{OUT} = 0\text{ V}$	-5	0	1.2	μA
		$V_{EN/UV} = 0\text{ V}$, $V_{OUT} = 300\text{ mV}$	100	137	190	μA
Output Current						
I_{LIM}	ILIM Bias Current			10		μA
I_{OL}	OUT Over-Load Current Limit	$R_{LIM} = 45.3\text{ k}\Omega$, $V_{IN-OUT} = 1\text{ V}$	2.0	2.3	2.6	A
		$R_{LIM} = 100\text{ k}\Omega$, $V_{IN-OUT} = 1\text{ V}$	3.45	3.75	4.05	A
		$R_{LIM} = 150\text{ k}\Omega$, $V_{IN-OUT} = 1\text{ V}$	4.8	5.1	5.4	A
$I_{LIM,SC}$	ILIM Short Current Limit	$R_{LIM} = 0\text{ }\Omega$		0.9		A
$I_{LIM,OP}$	ILIM Open Current Limit	$R_{LIM} = \text{open}$		0.9		A
$V_{LIM,OP}$	ILIM Open Sense Threshold	$R_{LIM} = \text{open}$, V_{LIM} rising		3.1		V

5-A E-fuse Protection Switches with Inrush Control

Parameter	Conditions	Min	Typ	Max	Unit
I _{SC}	R _{ILIM} = 45.3 kΩ, V _{IN-OUT} = 5 V, TPS05P50		2.05		A
	R _{ILIM} = 45.3 kΩ, V _{IN-OUT} = 12 V, TPS14P50		1.98		A
	R _{ILIM} = 100 kΩ, V _{IN-OUT} = 5 V, TPS05P50		3.56		A
	R _{ILIM} = 100 kΩ, V _{IN-OUT} = 12 V, TPS14P50		3.32		A
	R _{ILIM} = 150 kΩ, V _{IN-OUT} = 5 V, TPS05P50		4.95		A
	R _{ILIM} = 150 kΩ, V _{IN-OUT} = 12 V, TPS14P50		4.5		A
Ratio	Ratio of Fast-Trip Current Limit and Over-Load Current Limit	$\frac{I_{FAST_TRIP}}{I_{IL}}$		1.6	
Temperature Range					
T _{SD}	Thermal shutdown threshold		150		°C
	Thermal shutdown hysteresis		10		°C
Timing					
t _{ON,DLY}	Turn-On Delay Time	EN/UV↑ to V _{OUT} = 10% × V _{IN}		220	μs
t _{OFF,DLY}	Turn-Off Delay Time	EN/UV↓ to V _{OUT} = 90% × V _{IN}		0.4	μs
t _{dVdt}	Output Ramp-Up Time	C _{dVdt} = 0, V _{IN} = 5 V, EN/UV↑ to V _{OUT} = 90% × V _{IN} , TPS05P50		0.4	ms
		C _{dVdt} = 0, V _{IN} = 12 V, EN/UV↑ to V _{OUT} = 90% × V _{IN} , TPS14P50		0.4	ms
		C _{dVdt} = 1 nF, V _{IN} = 5 V, EN/UV↑ to V _{OUT} = 90% × V _{IN} , TPS05P50		5	ms
		C _{dVdt} = 1 nF, V _{IN} = 12 V, EN/UV↑ to V _{OUT} = 90% × V _{IN} , TPS14P50		5	ms
t _{FAST,DLY}	Fast-Trip Off Delay Time	I _{OUT} > I _{FASTTRIP} to I _{OUT} = 0		300	ns
t _{TSD,DLY}	Thermal Shutdown Recovery Delay Time (auto retry version)	V _{IN} = 5 V, TPS05P50		240	μs
		V _{IN} = 12 V, TPS14P50		240	μs

5-A E-fuse Protection Switches with Inrush Control

Typical Performance Characteristics

All test conditions: $V_{IN} = 12\text{ V}$ for TPS14P50, $V_{IN} = 5\text{ V}$ for TPS05P50, $V_{EN/UV} = 2\text{ V}$, $R_{LIM} = 100\text{ k}\Omega$, $C_{IN} = 0.1\text{ }\mu\text{F}$, $C_{OUT} = 1\text{ }\mu\text{F}$, $C_{dVdT} = \text{OPEN}$, $T_J = 25^\circ\text{C}$, unless otherwise noted.

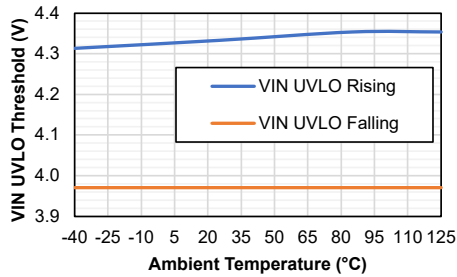

Figure 1. Supply Input UVLO vs Temperature

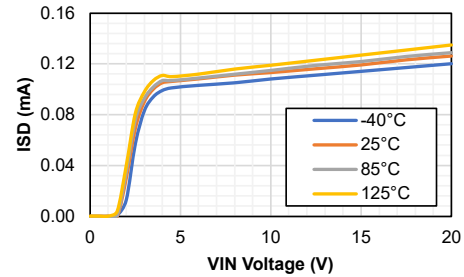
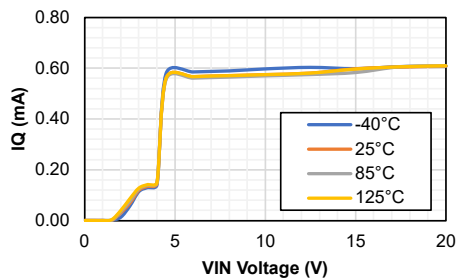
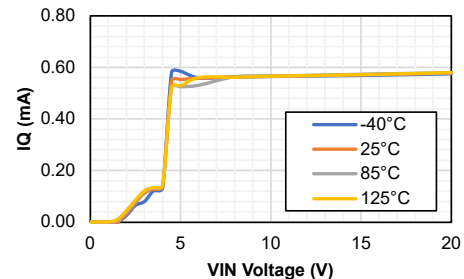

Figure 2. Shutdown Current vs Supply Voltage



TPS14P50

Figure 3. Quiescent Current vs Supply Voltage



TPS05P50

Figure 4. Quiescent Current vs Supply Voltage

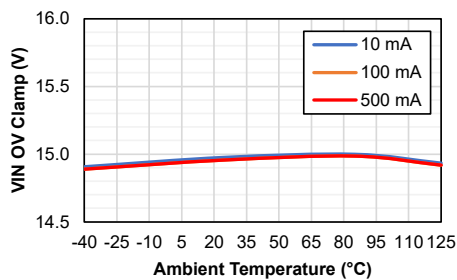

TPS14P50

Figure 5. Output Voltage Clamp vs Supply Voltage

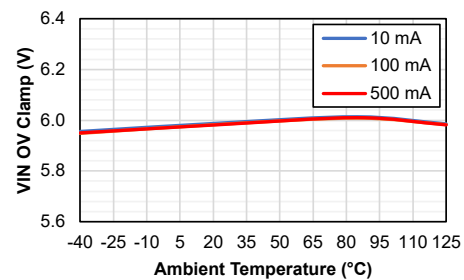

TPS05P50

Figure 6. Output Voltage Clamp vs Supply Voltage

5-A E-fuse Protection Switches with Inrush Control

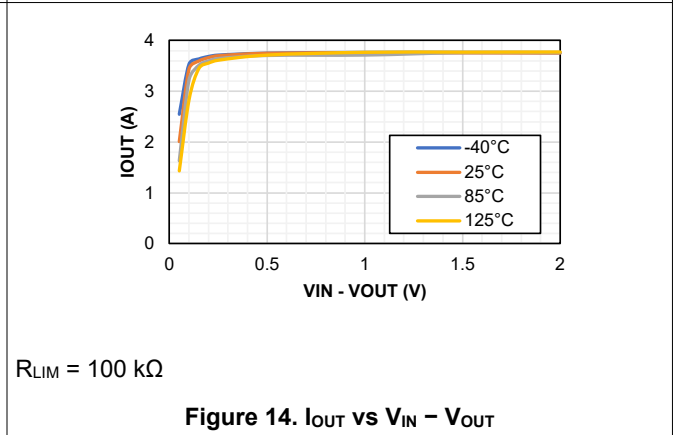
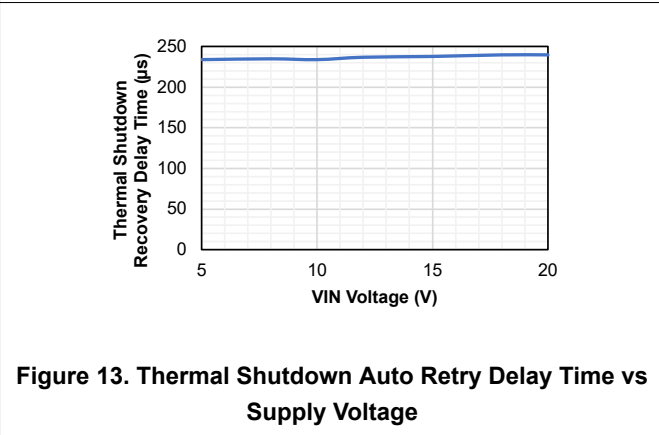
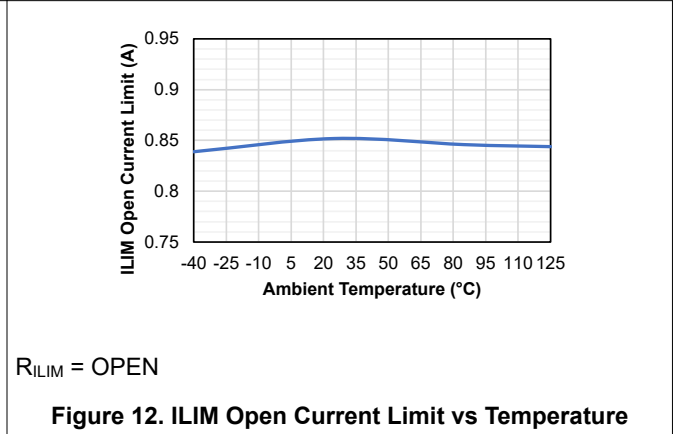
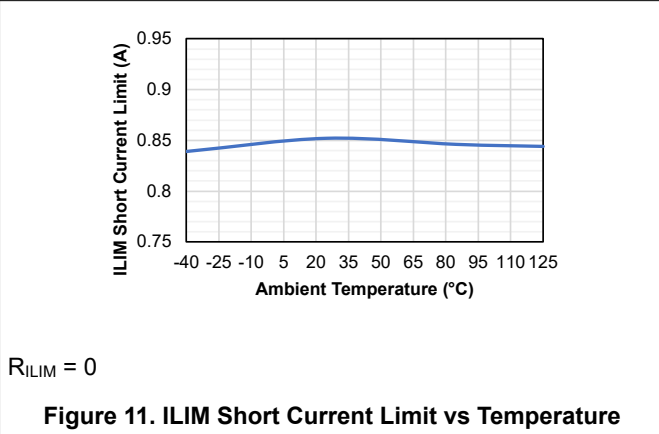
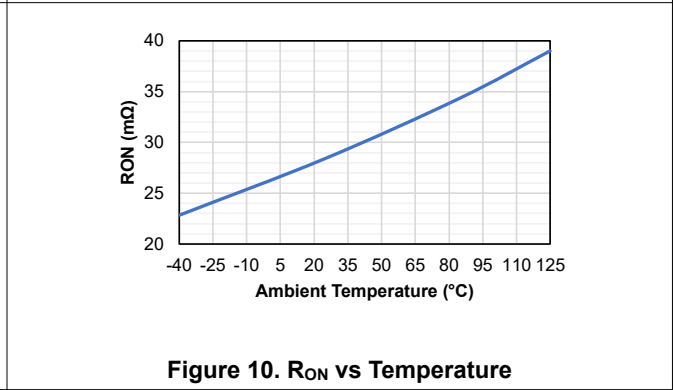
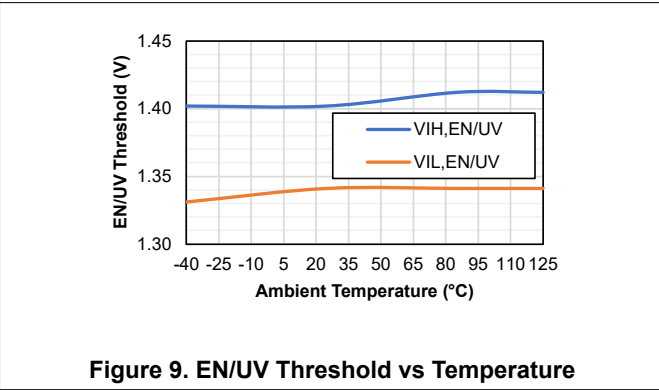
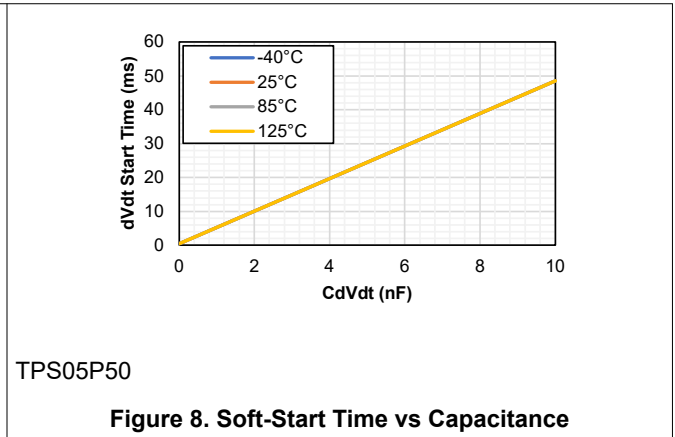
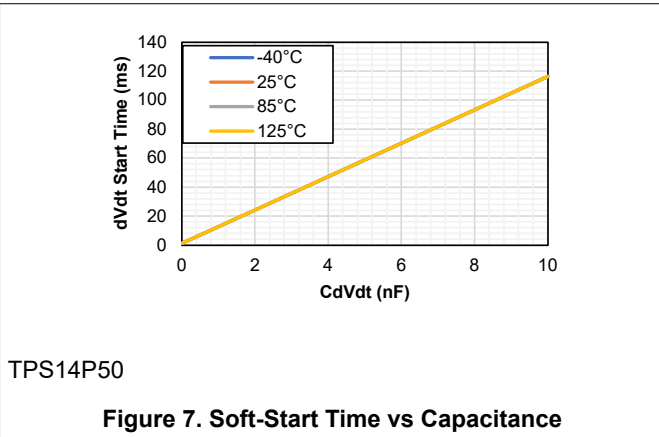

5-A E-fuse Protection Switches with Inrush Control

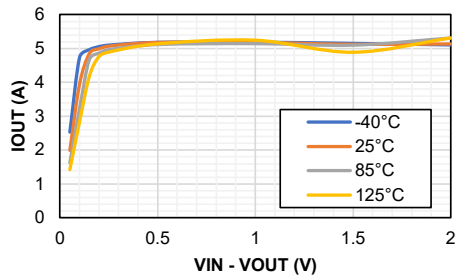

$R_{LIM} = 150\text{ k}\Omega$

Figure 15. I_{OUT} vs $V_{IN} - V_{OUT}$

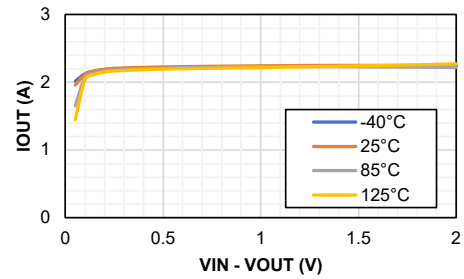

$R_{LIM} = 45.3\text{ k}\Omega$

Figure 16. I_{OUT} vs $V_{IN} - V_{OUT}$

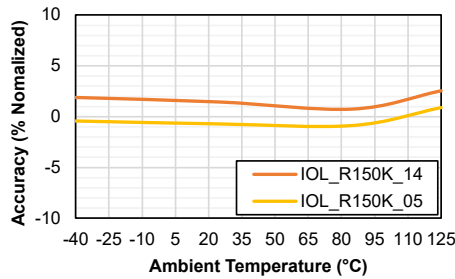

$R_{LIM} = 150\text{ k}\Omega$

Figure 17. Over-Load Accuracy vs Temperature

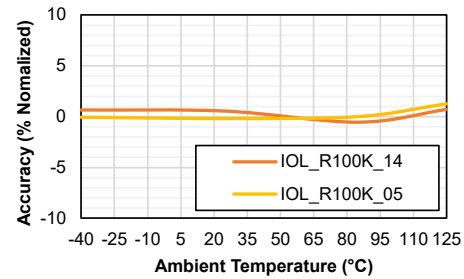

$R_{LIM} = 100\text{ k}\Omega$

Figure 18. Over-Load Accuracy vs Temperature

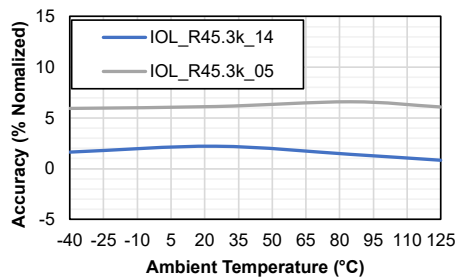

$R_{LIM} = 45.3\text{ k}\Omega$

Figure 19. Over-Load Accuracy vs Temperature

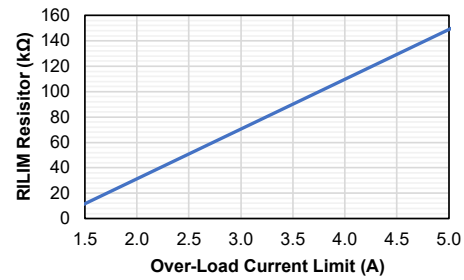
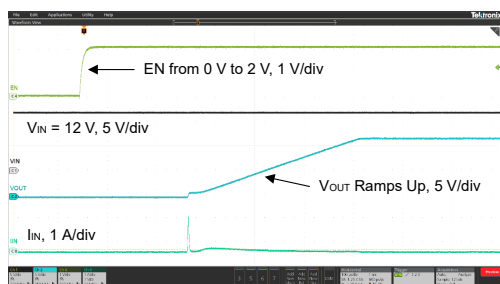
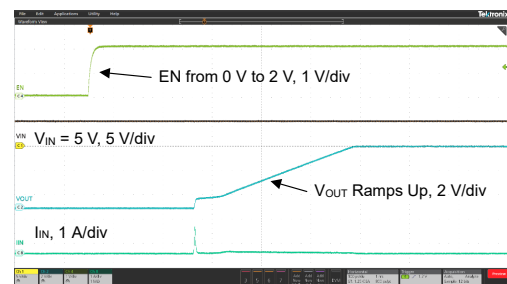

Figure 20. R_{LIM} Resistor vs Over-Load Current Limit



TPS14P50, $C_{dVdt} = 4.7\text{ }\mu\text{F}$, $C_{OUT} = 4.7\text{ }\mu\text{F}$

Figure 21. Startup with EN/UV



TPS05P50, $C_{dVdt} = 4.7\text{ }\mu\text{F}$, $C_{OUT} = 4.7\text{ }\mu\text{F}$

Figure 22. Startup with EN/UV

5-A E-fuse Protection Switches with Inrush Control

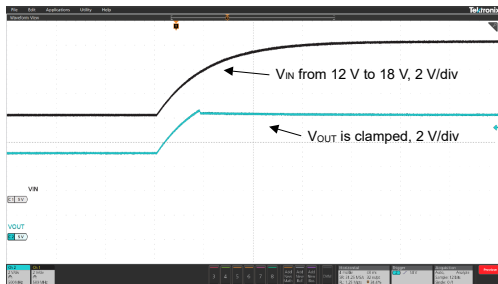

TPS14P50

Figure 23. Over-Voltage Clamp

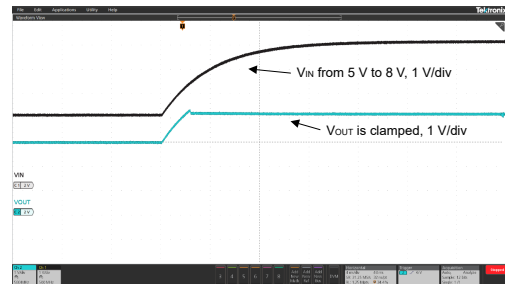

TPS05P50

Figure 24. Over-Voltage Clamp

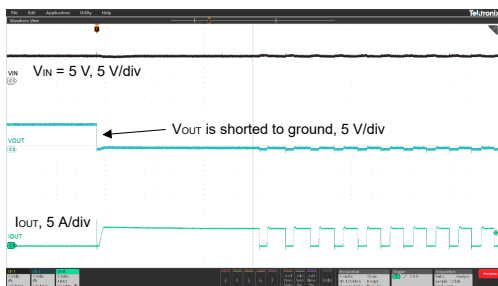

Auto-Retry Version

Figure 25. Thermal Shutdown Auto Retry

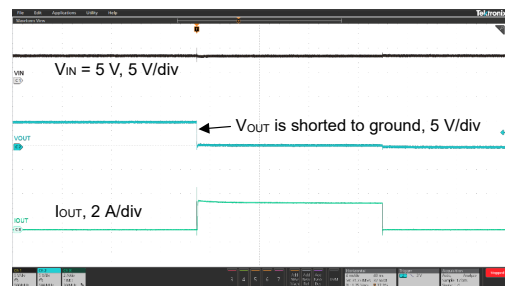

Latch Version

Figure 26. Thermal Shutdown Latch

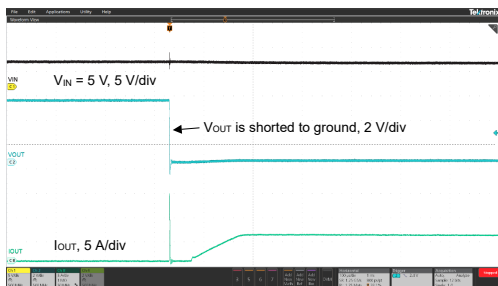

$V_{IN} = 5\text{ V}$, $R_{LIM} = 150\text{ k}\Omega$

Figure 27. Output Short to Ground

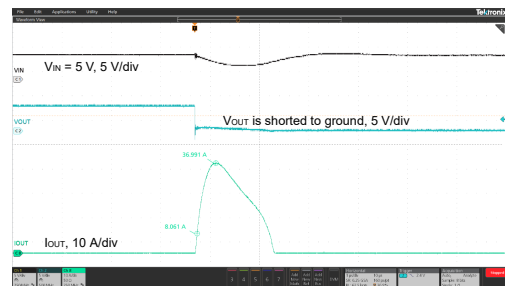

Figure 28. Output Short to Ground

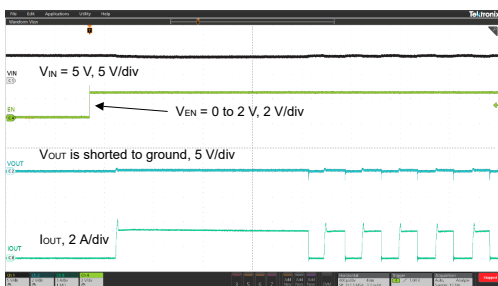

Figure 29. Enabled with Output Short to Ground

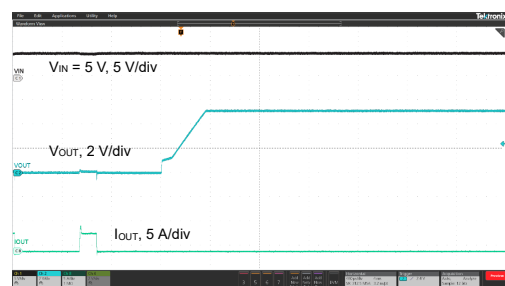

Figure 30. Recovery from Short to Ground

5-A E-fuse Protection Switches with Inrush Control



$V_{IN} = 12\text{ V}$, $R_{LIM} = 150\text{ k}\Omega$

Figure 31. Output Short to Ground

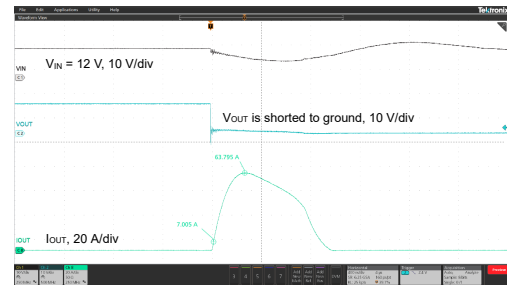

Figure 32. Output Short to Ground

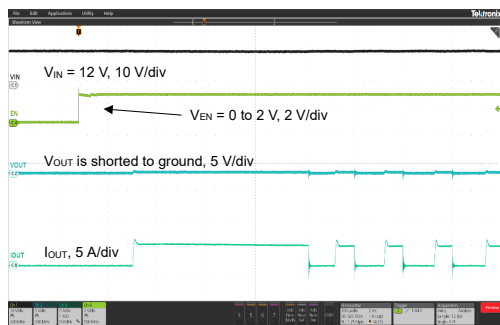

Figure 33. Enabled with Output Short to Ground

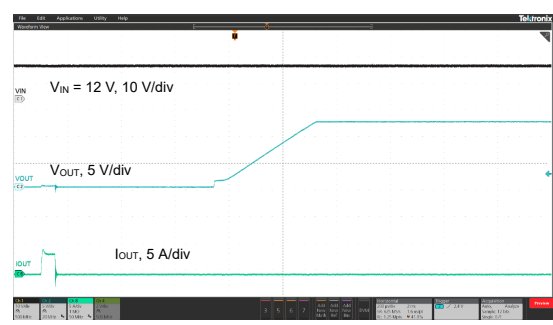

Figure 34. Recovery from Short to Ground

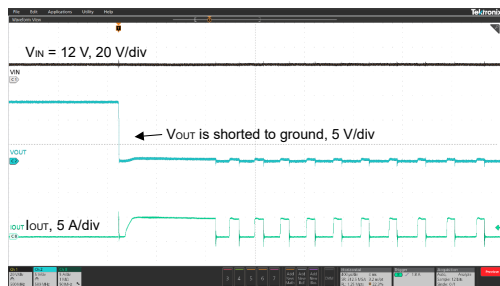

Figure 35. Thermal Shutdown Auto Retry



Load Stepped from 65% to 125%, back to 65%.

Figure 36. Over-Load Current Limit

Detailed Description

Overview

The TPS14P50 and TPS05P50 are 5-A e-fuse switches with voltage clamp and current limit protection functions integrated. The TPS14P50 integrates a 15-V over-voltage clamp and the TPS05P50 integrates a 6.1-V over-voltage clamp. The over-voltage clamp function can limit the output voltage during the input voltage surge to protect the load from damage. The TPS14P50 and TPS05P50 integrate an adjustable current limit function. The current limit level can be set from 2 A to 5 A by connecting an external resistor at the ILIM pin and the current limit accuracy is $\pm 15\%$ typically.

To limit the inrush current and meet the output voltage smoothly ramp-up requirement, the TPS14P50 and TPS05P50 integrate a soft-start function, which can be adjusted by a capacitor connected at the dVdt pin.

Functional Block Diagram

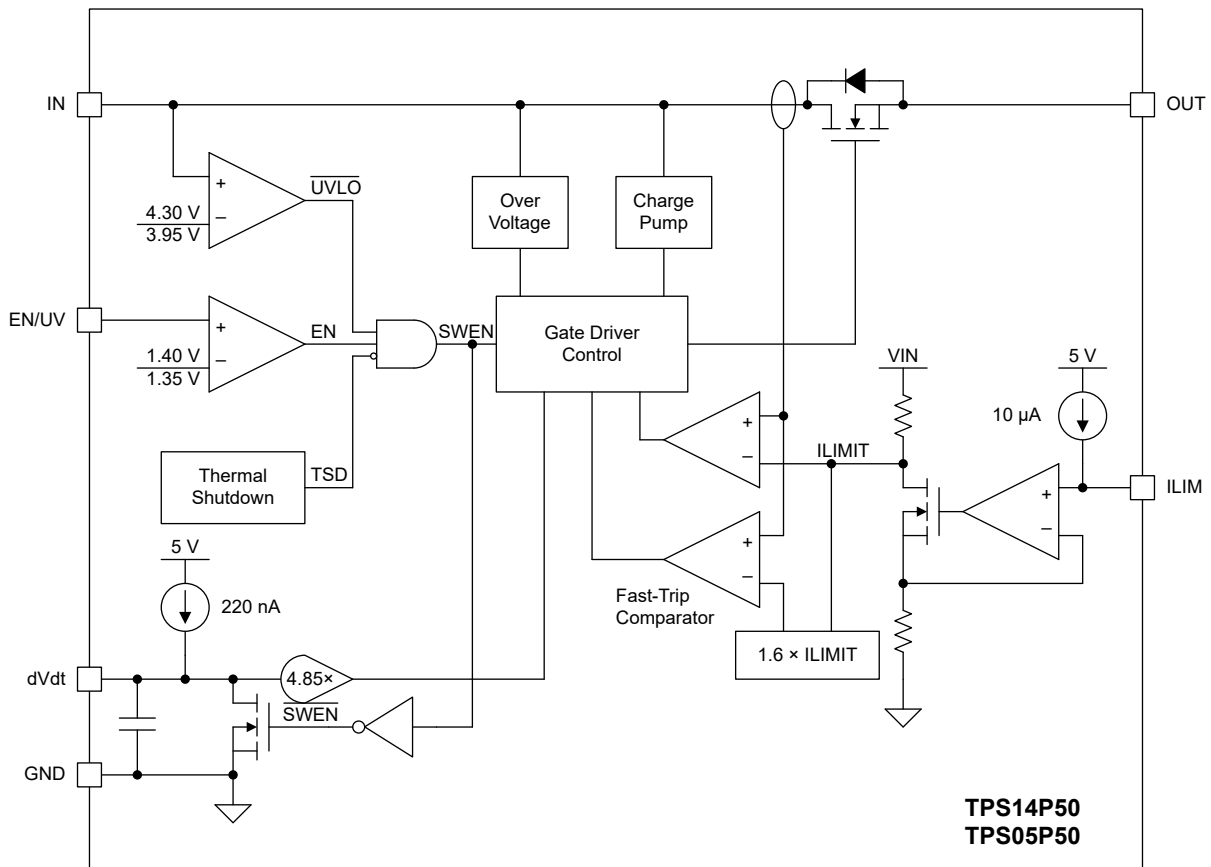

Figure 37. Functional Block Diagram

Feature Description

Under-Voltage Lockout (UVLO)

The TPS14P50 and TPS05P50 have two methods of controlling undervoltage lockout (UVLO): using V_{IN} UVLO threshold or using $V_{EN/UV}$ with external resistor divider.

5-A E-fuse Protection Switches with Inrush Control

For the $V_{EN/UV}$ threshold, it is adjustable with external resistor dividers R1 and R2. The value could be calculated with [Equation 1](#) and [Equation 2](#).

$$V_{UV,R} = \frac{R1 + R2}{R1} \times V_{IH,EN/UV} \quad (1)$$

$$V_{UV,F} = \frac{R1 + R2}{R1} \times V_{IL,EN/UV} \quad (2)$$

Where $V_{IH,EN/UV}$ is the rising threshold and $V_{IL,EN/UV}$ is the falling threshold. R1 and R2 are the resistors connected between IN, EN/UV and GND pins of the device.

The current through R1 and R2 could be calculated with [Equation 3](#). The resistor value should be selected according to the leakage current from V_{IN} . It is suggested to set current $I_{R1,R2}$ to be 20 times greater than the EN/UV pin leakage current ($I_{EN/UV}$).

$$I_{R1,R2} = \frac{V_{IN}}{R1 + R2} \quad (3)$$

For the V_{IN} UVLO threshold, refer to the Electrical Characteristics table for UVLO threshold and hysteresis. Please note, the EN/UV pin is rated only to 7 V maximum and it cannot be connected directly to $V_{IN} \geq 7$ V. Suggest connect R1 = 1 M Ω to limit the pull-up current below 20 μ A when R2 is open.

Over-Voltage Clamp (OVC)

For both TPS14P50 and TPS05P50, the absolute maximum voltage rating of IN pin is 20 V, and the recommended V_{IN} operating voltage range is 4.5 V to 14 V and 4.5 V to 5.5 V for TPS05P50 respectively. However, when the V_{IN} voltage is greater than the recommended operating voltage range, the device enters the over-voltage clamp (OVC) mode to limit the output voltage at V_{OVC} .

In the OVC mode, the power dissipation could be calculated with [Equation 4](#). Please note, the power dissipation could heat up the device and cause over-temperature protection.

$$P_{D,OVC} = (V_{IN} - V_{OVC}) \times I_{OUT} \quad (4)$$

Output Slew Rate Control (dVdt)

Both TPS14P50 and TPS05P50 support output slew rate control with the capacitor connected at the dVdt pin during device start up. The dVdt pin could be left open to use the inherent slew rate. When the dVdt capacitor is connected, the total output ramp-up time could be calculated with [Equation 5](#).

$$t_{dVdt} = \frac{V_{dVdt} \times V_{IN}}{I_{dVdt} \times GAIN} \times (C_{dVdt} + C_{INT}) + t_{INT} \quad (5)$$

Where:

- V_{dVdt} = 1.2 V, which is the dVdt external capacitor voltage;
- I_{dVdt} = 220 nA, which is the dVdt external capacitor charging current;
- C_{dVdt} is the dVdt external capacitor;
- C_{INT} = 70 pF, which is the dVdt internal capacitor;
- t_{INT} = 220 μ s, which is the internal delay time;
- GAIN is 6 V for TPS05P50 and 15 V for TPS14P50.

Output Current Limit (ILIM)

Both TPS14P50 and TPS05P50 use output current limit to protect the device during fault conditions, e.g., output is over loaded. The current limit value is set according to [Equation 6](#).

$$I_{OL} = 0.7 + 3 \times 10^{-5} \times R_{LIM} \quad (6)$$

5-A E-fuse Protection Switches with Inrush Control

Both TPS14P50 and TPS05P50 integrate a fast-trip comparator to protect the device. When a transient short circuit event occurs, the current through the power MOSFET will rise quickly. The fast-trip comparator is much more responsive than the current-limit amplifier, and it shuts down the device when $I_{OUT} > I_{FAST-TRIP}$ and limits the maximum short-circuit current. The fast-trip trigger threshold, $I_{FAST-TRIP}$, is set to $1.6 \times I_{OL}$. After the fast-trip current limitation, the output current gradually ramps up to the I_{OL} controller by the current-limit amplifier,

When device is operating in current-limit mode, the internal power dissipation (see [Power Dissipation](#)) will raise the junction temperature rapidly, and ultimately lead to the over-temperature protection

Over-Temperature Protection

The recommended operating junction temperature range is from -40°C to 125°C . When the junction temperature is between 125°C and the thermal shutdown (TSD) threshold, the regulator can still work well but will reduce the device lifetime for long-term use.

The over-temperature protection works when the junction temperature exceeds the thermal shutdown (TSD) threshold, which turns off the regulator immediately. When the device cools down and the junction temperature falls below the value, which equals to thermal shutdown threshold minus thermal shutdown hysteresis, the regulator turns on again.

Application and Implementation

Note

Information in the following application sections is not part of the 3PEAK's component specification and 3PEAK does not warrant its accuracy or completeness. 3PEAK's customers are responsible for determining suitability of components for their purposes. Customers should validate and test their design implementation to confirm system functionality.

Application Information

The TPS14P50 and TPS05P50 are 5-A e-fuse switches with voltage clamp and current limit protection features integrated. The following application schematic shows a typical usage of the TPS14P50 and TPS05P50.

Typical Application

Figure 38 shows the typical application schematic of the TPS14P50 and TPS05P50.

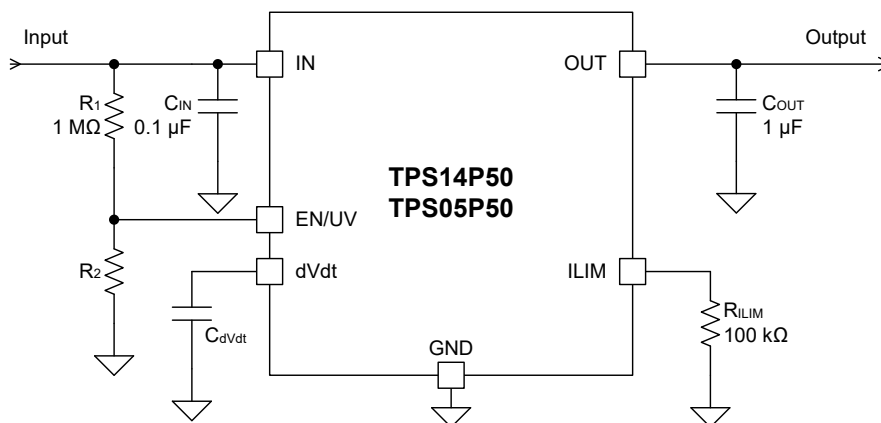

Figure 38. Typical Application Circuit

Input Capacitor and Output Capacitor

3PEAK recommends adding a 0.1 μF or greater ceramic capacitor closely at the IN pin to decouple the local noise and improve the transient performance. The voltage rating of the capacitors must be greater than the maximum input voltage.

The TPS14P50 and TPS05P50 are capacitor-free at the output. However, 3PEAK recommends adding a 1 μF or greater capacitor at the output pin to eliminate the undershoot during the large load transient condition.

Both input capacitors and output capacitors must be placed as close to the device pins as possible.

Power Dissipation

During normal operation, the junction temperature should meet the requirement in the Recommended Operating Conditions table. Use Equation 7 and Equation 8 to calculate the power dissipation and estimate the junction temperature.

The power dissipation (P_D) can be calculated using Equation 7.

$$P_D = I_{OUT}^2 \times R_{ON} + V_{IN} \times I_Q \tag{7}$$

Where,

- I_{OUT} is the output current,

5-A E-fuse Protection Switches with Inrush Control

- R_{ON} is the turn-on resistance,
- V_{IN} is the input supply voltage,
- I_Q is the quiescent current.

The junction temperature (T_J) can be estimated using [Equation 8](#).

$$T_J = T_A + P_D \times \theta_{JA} \quad (8)$$

Where,

- T_A is the ambient temperature,
- P_D is the power dissipation,
- θ_{JA} is the junction-to-ambient thermal resistance.

Layout

Layout Guideline

- Both input capacitors and output capacitors must be placed as close to the device pins as possible.
- It is recommended to bypass the input pin to ground with a 0.1- μF bypass capacitor. The loop area formed by the bypass capacitor connection, IN pin, and the GND pin of the system must be as small as possible.
- It is recommended to use wide and thick copper to minimize $I \times R$ drop and heat dissipation.

Layout Example

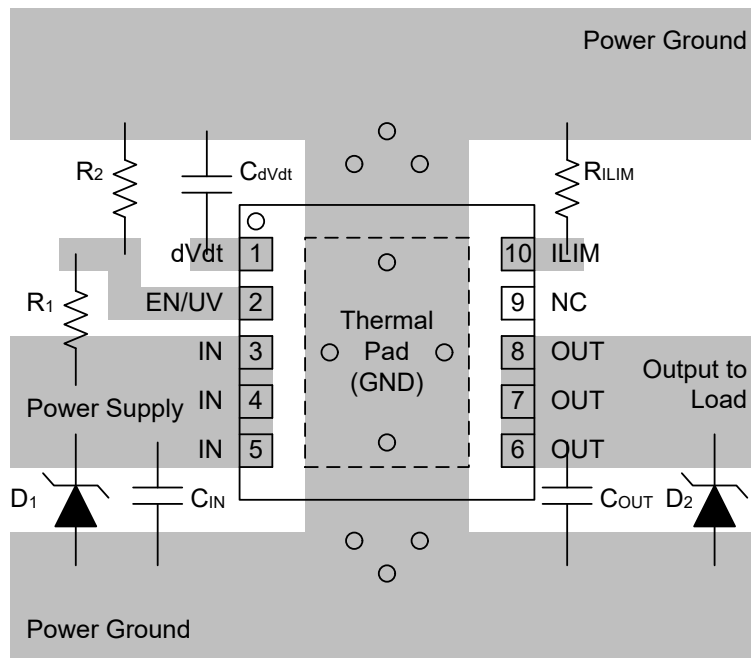

(1) D_1 and D_2 are only needed to suppress the transients caused by inductive load switching.

Figure 39. Layout Example

Tape and Reel Information

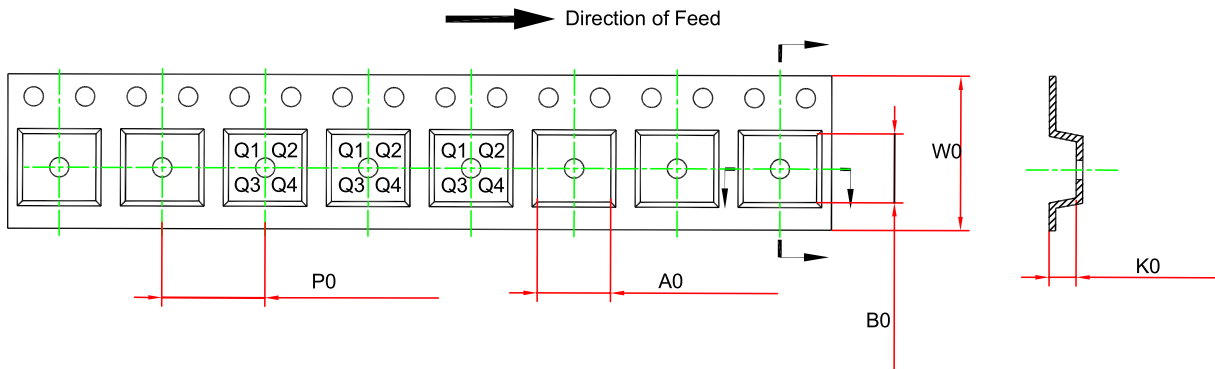
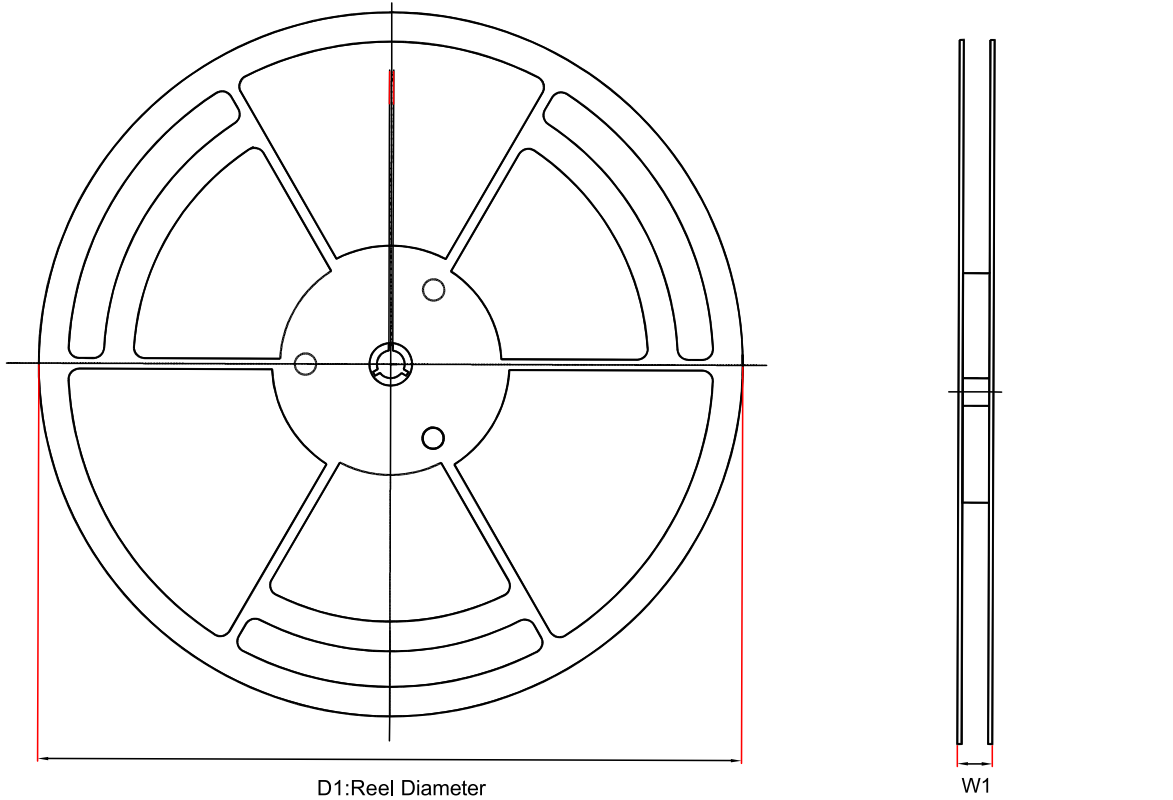

Order Number	Package	D1 (mm)	W1 (mm)	A0 (mm)	B0 (mm)	K0 (mm)	P0 (mm)	W0 (mm)	Pin1 Quadrant
TPS05P50A-DF8R	DFN3X3-10	330	17.6	3.3	3.3	1.1	8	12	Q2
TPS05P50B-DF8R	DFN3X3-10	330	17.6	3.3	3.3	1.1	8	12	Q2
TPS14P50A-DF8R	DFN3X3-10	330	17.6	3.3	3.3	1.1	8	12	Q2

5-A E-fuse Protection Switches with Inrush Control

Order Number	Package	D1 (mm)	W1 (mm)	A0 (mm)	B0 (mm)	K0 (mm)	P0 (mm)	W0 (mm)	Pin1 Quadrant
TPS14P50B- DF8R	DFN3X3-10	330	17.6	3.3	3.3	1.1	8	12	Q2

Package Outline Dimensions

DFN3X3-10-A

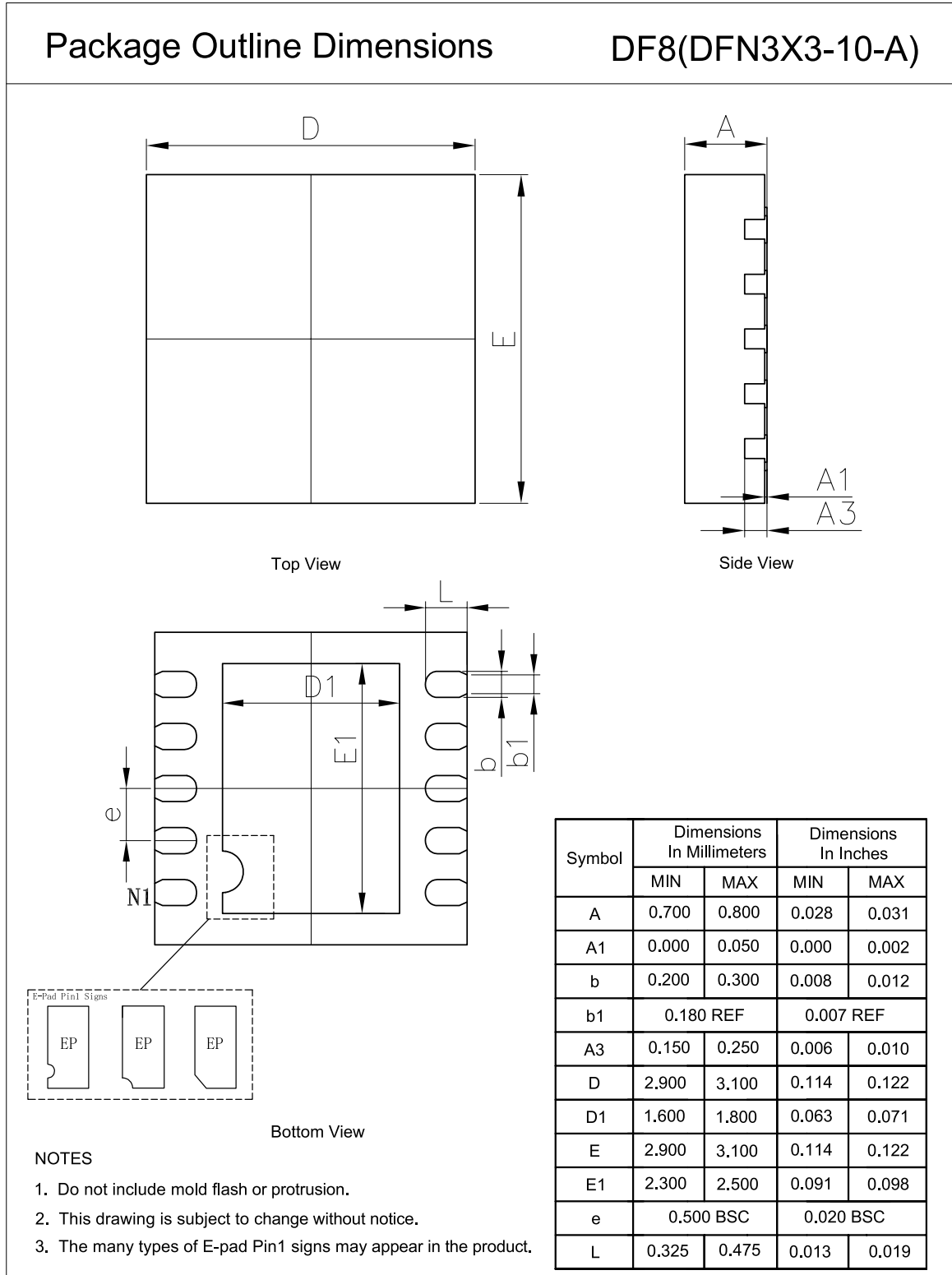

Order Information

Order Number	Operating Temperature Range	Package	Marking Information	MSL	Transport Media, Quantity	Eco Plan
TPS05P50A-DF8R	-40 to 150°C	DFN3X3-10	S055A	MSL3	Tape and Reel, 4,000	Green
TPS05P50B-DF8R	-40 to 150°C	DFN3X3-10	S055B	MSL3	Tape and Reel, 4,000	Green
TPS14P50A-DF8R	-40 to 150°C	DFN3X3-10	S145A	MSL3	Tape and Reel, 4,000	Green
TPS14P50B-DF8R	-40 to 150°C	DFN3X3-10	S145B	MSL3	Tape and Reel, 4,000	Green

Green: 3PEAK defines "Green" to mean RoHS compatible and free of halogen substances.

IMPORTANT NOTICE AND DISCLAIMER

Copyright© 3PEAK 2012-2024. All rights reserved.

Trademarks. Any of the 思瑞浦 or 3PEAK trade names, trademarks, graphic marks, and domain names contained in this document /material are the property of 3PEAK. You may NOT reproduce, modify, publish, transmit or distribute any Trademark without the prior written consent of 3PEAK.

Performance Information. Performance tests or performance range contained in this document/material are either results of design simulation or actual tests conducted under designated testing environment. Any variation in testing environment or simulation environment, including but not limited to testing method, testing process or testing temperature, may affect actual performance of the product.

Disclaimer. 3PEAK provides technical and reliability data (including data sheets), design resources (including reference designs), application or other design recommendations, networking tools, security information and other resources "As Is". 3PEAK makes no warranty as to the absence of defects, and makes no warranties of any kind, express or implied, including without limitation, implied warranties as to merchantability, fitness for a particular purpose or non-infringement of any third-party's intellectual property rights. Unless otherwise specified in writing, products supplied by 3PEAK are not designed to be used in any life-threatening scenarios, including critical medical applications, automotive safety-critical systems, aviation, aerospace, or any situations where failure could result in bodily harm, loss of life, or significant property damage. 3PEAK disclaims all liability for any such unauthorized use.



Singel 3 | B-2550 Kontich | Belgium | Tel.+32(0)3 458 30 33
info@alcom.be | www.alcom.be

Rivium 1e straat 52 | 2909 LE Capelle aan den IJssel | The Netherlands
Tel.+31(0)10 288 25 00 | info@alcom.nl | www.alcom.nl