

2023

RAILWAY CERTIFIED POWER SOLUTION GUIDE

POWER FOR
A BETTER FUTURE





AICOM

electronics

SINCE 1990

RAILWAY CERTIFIED POWER SOLUTIONS ENGINEERED BY MINMAX

The MINMAX Railway Certified DC-DC Converter family with powers ranging from 3 to 150 W are designed to meet stringent requirements and harsh environmental testing and are specifically designed to be the primary insulation barriers for railway DC power architectures. These railway certified DC-DC converters are available for DC battery bus voltages of 24, 36, 48, 72, 96, and 110 VDC, and for tight regulation for output voltages of 5, 12, 15, 24, 54, ± 12 , and ± 15 VDC. In accordance with EN 50155:2017 certification requirements, these railway certified DC-DC converters conform to the railway DC input-voltage range and transient/variation requirements; the voltage isolation/withstand test vibration and shock/bump test requirements in EN 61373; the cooling, dry, and damp heat test requirements in IEC/EN 60068-2-1, 2, and 30; and the EMC railway standards in EN 50121-3-2.

An advanced circuit topology provides a very high efficiency up to 93%, which allows a base plate temperature up to 105°C and very high I/O isolation up to 3000 VAC with reinforced insulation. Further features include overload, overvoltage, and short-circuit protection; remote ON/OFF; output trim; and output sense. For fire protection testing, these converters meet the EN 45545-2 standard to ensure system safety.

CONTENTS

THE INTRODUCTION OF RAILWAY CERTIFICATION EN 50155:2017

Fundamental Introduction	03
Input Voltage Specification Test for EN 50155 Railway Certification	04
Voltage Isolation/Withstand Test for EN 50155 Railway Certification	05
Electromagnetic Capability (EMC) Test for EN 50155:2017 Railway Certification	06
Environmental Requirement Test for EN 50155 2017 Railway Certification	07-08
Mechanical Requirements Test for EN 50155 2017 Railway Certification	09
Fire Protection Test of the EN 45545-2 Standard	10-11

HIGHLIGHTED PERFORMANCE OF RAILWAY CERTIFIED PRODUCTS

MINMAX RAILWAY CERTIFIED POWER SOLUTIONS

Successful Application	26
Railway Certified Products Overview	28
Railway Certified 3W DIP Package DC-DC Converters	29
Railway Certified 10-40W 2"x1" Package DC-DC Converters	29-30
Railway Certified 50-150W Quarter Brick DC-DC Converters	31-32

THE INTRODUCTION OF RAILWAY CERTIFICATION EN 50155:2017

FUNDAMENTAL INTRODUCTION

- Trains and high-speed rail have become more technically advanced and passenger-friendly with many additional infotainment systems and critical safety equipment. These types of electrical systems and functions, such as monitoring sensors around the train; air conditioning; lighting; and door-opening, communication, and entertainment systems, will inherently include CPUs, DSPs, analog circuitry, and highly sensitive sensors, which all must be powered from the railway storage battery system within the train.
- Modern trains and high-speed rail achieve reductions in weight and space by using a vehicle battery voltage up to 72 V or 110 VDC, but most electronic equipment/systems require input voltages of 5, 12, 15, 24, and 54 VDC. Basically, there are many railway certified DC-DC converters between the electronic equipment/systems and train's storage battery to transform the basic 72 V or 110 VDC into 5, 12, 15, 24, and 54 VDC.
- Moreover, the train's storage battery is typically located within the drive train locomotive at the front or rear of the vehicle. Therefore, the DC voltage is supplied over long distances by a power cable to the electronic equipment/system. These long power-cable lengths can pick up electromagnetic disturbances, induced transient voltage spikes (caused by nearby lightning strikes), and power-line fluctuations. The train's storage battery is also used to drive starter motors, pumps, compressors, drivers, relay coils, and other switch gears. These and other high-power loads are connected to the alternator, generator, and transformers. The end result of this environment is an unstable, highly fluctuating, noisy power source. It can also cause the risk of dangerous energy shocks due to excess energy hazards such as electric shocks, transient voltage spikes, mechanical damage, shorts developing between PCB tracks, air gaps, arcing, and ground loops, which cause ignition and fire situations. Each of these situations will extremely impact/interfere with the train's electronic equipment/system, resulting in a failure. Thus, we conclude that high-performance, high-isolation (with reinforced insulation), high-robustness, reliable, rugged, durable, uninterruptible railway certified DC-DC converters between the electronic equipment/system and the train's storage battery are necessary for long-term stable operation of the train's equipment and systems.
- Therefore, MINMAX railway certified DC-DC converters between the train's storage battery and electronic equipment/system, which are integrated into train/rolling stock applications must comply with the international railway certification "EN 50155:2017(IEC 60571): Railway Application Electronic Equipment Used on Rolling Stock." This certification covers specification requirements including the input voltage specification test, I/O voltage isolation test, insulation test, Electromagnetic Capability (EMC) test, mechanical requirement test, and harsh environmental test including the operating temperature test and the humidity, cooling, dry heat and damp heat tests that trains/rolling stock electronic equipment must meet.
- The right product is essential, but it is not everything. In addition to our product offerings, we provide a comprehensive range of services, including analysis and qualification in the development stage, demand planning and special logistics in the production phase, and end-user support in the aftermarket.
MINMAX aim to serve you with sincerity to ensure that your customers return time and again.

INPUT VOLTAGE SPECIFICATION TEST FOR EN 50155:2017 RAILWAY CERTIFICATION

• In the case of railway certified DC-DC converters, the input port must interface with the train's storage battery power source. The standard specifies that the input-voltage range of the converters must be operated in the same range as the train's storage battery voltage during normal operation.

A surge voltage test is specified to cover extreme variations, in addition to the minimum insulation requirements for safety.

• Nominal DC input voltages (VN) of 24, 36, 48, 72, 96, and 110 VDC are usually provided by the train's storage battery power sources used as the primary insulation barrier in the railway DC power architecture.

• MINMAX railway certified DC-DC converters powered directly from batteries with no voltage stabilizing device must function properly with input voltages that range from 0.7VN to 1.25VN during normal operation.

Further, these converters also withstand input voltage drops of 0.6VN for 100 ms and overvoltage surges of 1.4VN for 1s that may occur during startup.

The table below summarizes, with some exceptions, the MINMAX railway certified DC-DC converters that cover all the specified input ranges, brown-outs, transients, and voltage spikes for the permanent operation of a train's electronic equipment system.

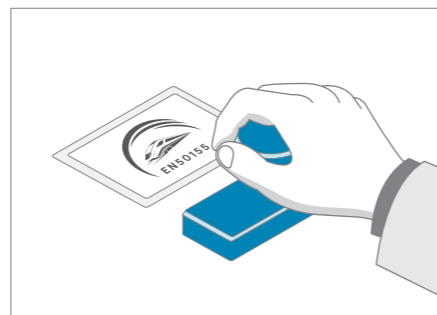

Phenomenon	EN 50155 Reference Clause / Standard	
	Standard Test Level	MINMAX Test Level
Supply Variations	EN 50155 13.4.1/ EN 50155 5.1.1.1	
	Test Voltage / Time: 0.7 VN / 10min. Test Voltage / Time: VN / 10min. Test Voltage / Time: 1.25 VN / 10min. Test Voltage / Time: 0.6 VN / 0.1sec. Test Voltage / Time: 1.4 VN / 0.1sec. Test Voltage / Time: 1.4 VN / 1sec. Test Number: repeated 10 times	Test Voltage / Time: 0.7 VN // 60min. Test Voltage / Time: VN / 60min. Test Voltage / Time: 1.25 VN / 60min. Test Voltage / Time: 0.6 VN / 10min. Test Voltage / Time: 1.4 VN / 10min. Test Voltage / Time: 1.4 VN / 60min. Test Number: repeated 10 times
Supply Interruptions	EN 50155 13.4.3 / EN 50155 5.1.1.2	
	Class S1: 100%VN / 0mS Class S2: 100%VN / 10mS Test Number: repeated 10 times	Class S1: 100%VN / 0mS Class S2: 100%VN / 10mS* Test Number: repeated 10 times
Supply Change Over	EN 50155 13.4.3 / EN 50155 5.1.1.3	
	Class C1: Dip 40%VN / 100mS Class C2: Interruptions 100%VN / 30mS Test Number: repeated 10 times	Class C1: Dip 40%VN / 100mS & 10min. Class C2: Interruptions 100%VN / 30mS* Test Number: repeated 10 times
Supply Over Voltages	EN 50155 13.4.3	
	Voltage Level / Duration: 1.4 VN / 0.1sec. Voltage Level / Duration: 1.4 VN / 1sec. Test Number: repeated 10 times	Voltage Level / Duration: 1.4 VN / 10min. Voltage Level / Duration: 1.4 VN / 60min. Test Number: repeated 10 times

*Note: Peripheral Components Needed, Please Contact MINMAX for More Information.

VOLTAGE ISOLATION/WITHSTAND TEST FOR EN 50155:2017 RAILWAY CERTIFICATION

• Railway certified DC-DC converters have significantly played a crucial role in the certification of on-train electrical equipment.

• A 2000-VAC isolation/withstand voltage test with reinforced insulation of the MINMAX railway certified DC-DC converters will verify the design creepage, air clearances, and insulation level of the power module demands.

The above criteria comply with the limited leakage current under normal/single-fault conditions and protect sensitive circuit loads from noise, electromagnetic disturbances, power bus fluctuations, surges, electrical shocks, transient voltage spikes, insulation breakdown of the power architecture, mechanical damage, shorts developing between PCB tracks, air gaps, arcing, and ground loops, which cause ignition and fire situations.

Phenomenon	EN 50155 : 2017 Reference Clause	
	Standard Test Level	MINMAX Test Level
Isolation / Withstand Voltage Test	EN 50155 13.4.9	
	Test Voltage / Time: 1500VAC / 60sec.	Test Voltage / Time: 2000VAC / 60sec.

ELECTROMAGNETIC CAPABILITY (EMC) TEST FOR EN 50155:2017 RAILWAY CERTIFICATION

• Electromagnetic compatibility (EMC) is another main category of the EN 50155 certification.

MINMAX railway certified DC-DC converters are approved at the European EN 50121-3-2 standard "Railways Applications Electromagnetic Compatibility Part 3-2 Rolling Stock Apparatus," which states that the power module should not emit conducted and radiated electromagnetic interference (EMI) in excess of the defined levels and should be protected from outside negative effects due to conduction, radiation, surges, ESD, and EFT interference.

ELECTROMAGNETIC CAPABILITY (EMC) TEST FOR EN 50155:2017 RAILWAY CERTIFICATION

EMC	Phenomenon	EN 50155 Reference Clause / Standard	
		Standard Test Level	MINMAX Test Level
EMI	Conducted Emission	EN 50155 13.4.8 / EN 50121-3-2, EN 55016-2-1	
		Frequency / level: 5~30MHz / 93 dBuV Frequency / level: 0.5~5MHz / 93 dBuV Frequency / level: 0.15~0.5MHz / 99 dBuV	Frequency / level: 5~30MHz / 60 dBuV* Frequency / level: 0.5~5MHz / 60 dBuV* Frequency / level: 0.15~0.5MHz / 66 dBuV*
EMI	Radiated Emission	EN 50155 13.4.8/ EN 50121-3-2, EN 55016-2-1	
		Frequency / level: 30~230MHz / 40 dB(uV/m) Frequency / level: 230~1000MHz / 47 dB(uV/m) Frequency / level: 30~230MHz / 40 dB(uV/m)*	Frequency / level: 30~230MHz / 40 dB(uV/m)* Frequency / level: 230~1000MHz / 47 dB(uV/m)*
EMS	ESD Immunity Test	EN 50155 13.4.8 / EN 50121-3-2, EN 61000-4-2	
		Air Discharge: ±8KVDC Contact Discharge: ±6KVDC Indirect Discharge HCP & VCP: ±6KVDC	Air Discharge: ±8KVDC Contact Discharge: ±6KVDC Indirect Discharge HCP & VCP: ±2/4/6KVDC
	Radio-Frequency, Electromagnetic Field Immunity Test	EN 50155 13.4.8 / EN 50121-3-2, EN 61000-4-3	
		Frequency / Field: 5100~6000MHz/3 V/m Frequency / Field: 2000~2700MHz/5 V/m Frequency / Field: 1400~2000MHz/10 V/m Frequency / Field: 80~1000MHz/20 V/m	Frequency / Field: 5100~6000MHz/5 V/m Frequency / Field: 2700~5000MHz/10 V/m Frequency / Field: 2000~2700MHz/10 V/m Frequency / Field: 1400~2000MHz/20 V/m Frequency / Field: 80~1000MHz/20 V/m Frequency / Field: 27~80MHz/20 V/m
	Electrical Fast Transient/Burst Immunity Test	EN 50155 13.4.8 / EN 50121-3-2, EN 61000-4-4	
		Line, Neutral, Line+Neutral: ±2KVDC	Line, Neutral, Line+Neutral: ±2KVDC*
	Surge Immunity Test	EN 50155 13.4.8 / EN 50121-3-2, EN 61000-4-5	
		Line to Line: ±1KVDC	Line to Line: ±2KVDC*
EMI	Radio-Frequency, Conducted Disturbances Immunity Test	EN 50155 13.4.8 / EN 50121-3-2, EN 61000-4-6	
		Frequency : 0.15 to 80MHz Field: 10 Vrms	Frequency : 0.15 to 80MHz Field: 10 Vrms
EMI	Power Frequency Magnetic Field Immunity Test	EN 61000-4-8	
		No Needed	Frequency: 50Hz Field: 30/100/1000 A/m
EMI	Damp Oscillatory Magnetic Field Immunity Test	EN 61000-4-10	
		No Needed	Frequency: 0.1 & 1 MHz Field: 30 A/m

*Note: Peripheral Components Needed, Please Contact MINMAX for More Information.

ENVIRONMENTAL REQUIREMENT TEST FOR EN 50155:2017 RAILWAY CERTIFICATION

• Operating Temperature Range Requirement

The operating temperatures are divided into four classes according to the severity of the environment, as summarized in the table below. When designing railway certified DC-DC converters, it is necessary to consider the over-temperature during startup, as indicated in the third column.

Table 1 - Operating Temperature Rating

Class	Equipment Operating Temperature Range(°C)
OT1	-25°C to +55°C
OT2	-40°C to +55°C
OT3	-25°C to +70°C
OT4	-40°C to +70°C
OT5	-25°C to +85°C
OT6	-40°C to +85°C

The OT5 and OT6 types cannot serve as the general specifications of temperature requirements for vehicles (but can be used in the semiconductor drive unit (SDU), engine control unit).

The OT1 and OT2 types are suitable for passenger compartments and driver's cab. The long-term temperature must be maintained at 25°C, while the temperature at the passenger compartments and driver's cab can affect the service life of the material. The OT3 and OT4 types are ideal for the equipment in the cabinets with a long-term reference temperature of 45°C. This ambient temperature can also affect the service life of the material.

The indoor temperature rise should be considered during design phase to ensure that the temperature of the components will not exceed the specified rated temperature. For example, if the air temperature around the PCB rises by about 15°C (this temperature rise depends mainly on the power consumption of the PCB itself and the adjacent PCB, or the natural airflow, enforced airflow, etc.). While designing the PBA, we should consider placing one PBA horizontally or vertically; or allow the sub-racks of the PBA to be stacked together. The suppliers should consider the requirements imposed by specific onboard installations.

In some exceptional cases (such as partitions, effects of sunlight, the shutdown of the auxiliary cooling system), the additional operational checks on the switch-on equipment should be processed under a short-term thermal condition based on the status of ST1 or ST2 as shown in Table 2 (Page 08).

ENVIRONMENTAL REQUIREMENT TEST FOR EN 50155:2017 RAILWAY CERTIFICATION

Table 2 - Switch-on Status of the Extended Operating Temperature Rating

Class	Switch-On Extended Operating Temperature (Duration: 10 min)
ST0	No Switch-On Extended Operating Temperature
ST1	OTx + 15°C
ST2	OTx + 15°C

Operating Temperature and Humidity Test

Phenomenon	EN 50155 : 2017 Reference Clause / MINMAX Test Level
Low Temperature Start-up Test	EN 50155 13.4.4 / EN 60068-2-1
	Test Curve Follow by EN 50155 : 2017 with: · Operating Temperature Class : OT4 · Continuous Operation Checks Period: 8 HRs
Dry Heat Test	EN 50155 13.4.5 / EN 60068-2-2
	Test Curve Follow by EN 50155 : 2017 with: · Operating Temperature Class: OT4 · Switch-On Extended Operating Temperature Range Class: ST2 · Thermal Test Cycle: C · Continuous Operational Checks Period: 8 HRs
Low Temperature Storage Test	EN 50155 13.4.6 / EN 60068-2-1
	Test Curve Follow by EN 50155 : 2017 with: · Temperature / Dwell Time: 16HRs in storage
Cyclic Damp Heat Test	EN 50155 13.4.7 / EN 60068-2-30
	Test Curve Follow by EN 50155 : 2017 with: · Test Temperature (T _{TEST}) under Equip. Switched ON: +70°C · Continuous Operation Checks Period under Equip. Switched ON: 24HRs · Test Temperature (T _{TEST}) of Recovery Period under Equip. Switched OFF: +70°C

MECHANICAL REQUIREMENTS TEST FOR EN 50155:2017 RAILWAY CERTIFICATION

Vibration and Increased Vibration Test

- The EN 50155 certification specifies that railway certified DC-DC converters mounted on boards and boxes fixed to the railway/railroad vehicle frame must be able to withstand and satisfy the stringent EN 61373 vibration and shock test. Therefore, the manufacturing processes must be rigorously controlled to ensure consistent performance.

The entire process requires dedication and commitment to serve the special needs of rolling-stock on board electronics.

MINMAX railway certified DC-DC converters have been specially designed for high shock and vibration tolerances are able to withstand, without deterioration or malfunction, such conditions in compliance with EN 61373 standards.

Phenomenon	EN 50155 : 2017 Reference Clause / Standard	
	Standard Test Level	MINMAX Test Level
Functional Random Vibration Test	EN 50155 13.4.11 / EN 61373 (EN 60068-2-6)	
	Category 1, Class B, Body Mounted Frequency Range: 5Hz~150Hz Grms Value: 0.102 Grms (1.0 m/s ²) for Each Axis Dwell Time: 10min/axis in Storage	Category 1, Class B, Body Mounted Frequency Range: 5Hz~250Hz Grms Value: 0.2 Grms (2.0m/s ²) for Each Axis Dwell Time: 10min/axis in Operation
Increased Random Vibration Test	EN 50155 13.4.11 / EN 61373 (EN 60068-2-6)	
	Category 1, Class B, Body Mounted Frequency Range: 5Hz~150Hz Grms Value: 0.806 Grms (7.9m/s ²) for Each Axis Dwell Time: 5 HRs/axis in Storage	Category 1, Class B, Body Mounted Frequency Range: 5Hz~250Hz Grms Value: 1.2 Grms (12m/s ²) for Each Axis Dwell Time: 5 HRs/axis in Operation
Shock Test	EN 50155 13.4.11 / EN 61373 (EN 60068-2-27)	
	Category 1, Class A&B, Body Mounted Wave Form: Half-Sine Acceleration Peak: 5.102 Grms (50m/s ²) for Each Axis Dwell Time: 30mS in Storage Shock/Bump Times: 3 Times for Each Direction	Category 3, Axle Mounted Wave Form: Half-Sine Acceleration Peak: 5.102 Grms (50m/s ²) for Each Axis Dwell Time: 30mS in Operation Acceleration Peak: 10 Grms (100m/s ²) for Each Axis Dwell Time: 11mS in Operation Acceleration Peak: 100 Grms (1000m/s ²) for Each Axis Dwell Time: 6mS in Operation Shock Times: 3 Times for Each Direction
Bump Test	No Reference / No Reference (EN 60068-2-29)	
	No Needed	Wave Form: Half-Sine Acceleration Peak: 5.102 Grms (50m/s ²) for Each Axis Dwell Time: 30mS in Operation Acceleration Peak: 10 Grms (100m/s ²) for Each Axis Dwell Time: 11mS in Operation Bump Times: 2000Bumps for Each Direction

FIRE PROTECTION TEST OF THE EN 45545-2 STANDARD

- The railway/railroad transportation industry generally requires power module materials to meet the relevant requirements of the EN 45545-2 fire protection test standard. The EN 45545-2 guidelines specify that different materials under test shall be classified, and their "fire safety index parameter and test tions" are defined according to different categories of R1-R26.

Test Content:

1. Functional descriptions of firesafe samples
2. Fire safety requirements of homogeneous materials
3. Component materials of internal structure

The following index parameters are used to evaluate fire protection capabilities:

Heat release rate, Combustibility, Smoke toxicity, Smoke opacity

- The fire protection grades (HL Levels) of different materials under testing will be evaluated based on the final test data of the "fire safety index parameter".
- The fire protection grades of materials required for railway/railroad vehicles will be classified according to the vehicle's operating environment, different vehicle categories, as well as referencing the table below (Table 1 - Hazard Level Classification).

Table 1 – Hazard Level Classification

Operation category	Design category			
	N : Standard vehicles	A: Vehicles forming part of an automatic train having no emergency trained staff on board	D: Double decked vehicles	S: Sleeping and couchette vehicles
1	HL1	HL1	HL1	HL2
2	HL2	HL2	HL2	HL2
3	HL2	HL2	HL2	HL2
4	HL3	HL3	HL3	HL3

FIRE PROTECTION TEST OF THE EN 45545-2 STANDARD

Operation Category 1

Vehicles for operation on infrastructure where railway vehicles may be stopped with minimum delay, and where a safe area can always be reached immediately.

Operation Category 2

Vehicles for operation on underground sections, tunnels and/or elevated structures, with side evacuation available and where there are stations or rescue stations that offer a place of safety to passengers, reachable within a short running time.

Operation Category 3

Vehicles for operation on underground sections, tunnels and/or elevated structures, with side evacuation available and where there are stations or rescue stations that offer a place of safety to passengers, reachable within a long running time.

Operation Category 4

Vehicles for operation on underground sections, tunnels and/or elevated structure, without side evacuation available and where there are stations or rescue stations that offer a place of safety to passengers, reachable within a short running time.

- The fire protection grades (HL Level) of all plastic housings, printed circuit boards (PCBs), and potting compounds of all MINMAX's railway certified power modules will be evaluated based on the final test results of the "fire safety index parameter" to ensure safety during railway/railroad vehicle operation.

HIGHLIGHTED PERFORMANCE OF RAILWAY CERTIFIED PRODUCTS

Ultra-wide Input Voltage Range

- Provide ultra-wide input voltage range between 36-160VDC to meet different railway DC bus usage requirements.
- The 36VDC input is tailored for systems requiring low-voltage start-up.
- Support full output power cover whole input voltage range.

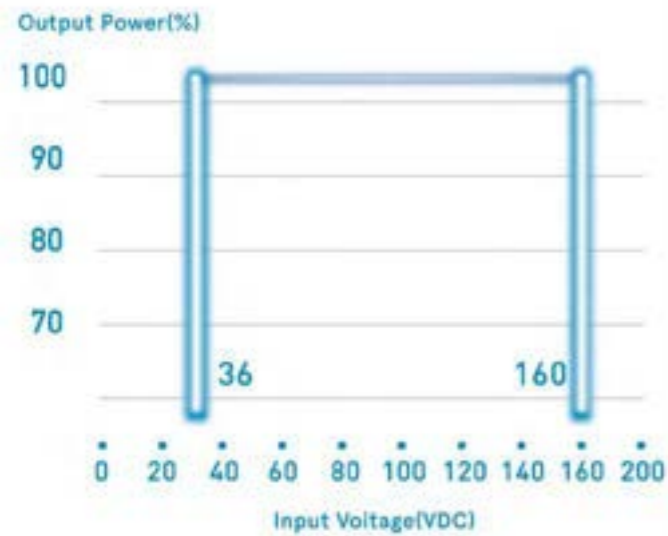

* Example : MRZ1150 Series

* Please refer to the "Input Voltage Specification Test for EN 50155 Railway Certification" on Page 04 for more information.

High Precision Output Voltages

Designed with high-precision output voltages to prevent significant operation changes by input voltage, output load current and ambient temperature uncertainty from causing a negative impact on railway systems.



* Example : MRZ1150 Series

* Please refer to the "Input Voltage Specification Test for EN 50155 Railway Certification" on Page 04 for more information.

Reinforce Insulation & 2KVAC Isolation for System Safety

The 2KVAC I/O isolation with reinforced insulation and vacuum encapsulated creates a solid electrical barrier which to protect sensitive circuit load from noise, electromagnetic disturbances, power bus fluctuation, surge, electric shock, transient voltage spike, insulation breakdown of power architecture, mechanical damage and short developing between PCB tracks, air gaps, arcing and ground loop. Thus provide safety on long-term operation of railway/railroad equipment.

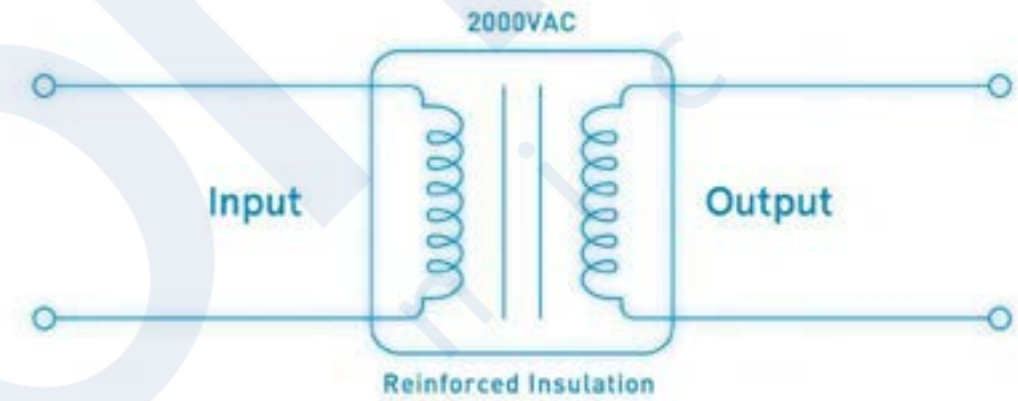

* Example : MRZ1150 Series

* Please refer to the "Voltage Isolation/Withstand Test for EN 50155 Railway Certification" on Page 05 for more information.

Optimized Thermal Structure Design

Through optimized thermal structure design (such as the high thermal conductive adhesives, Low Thermal Impedance Components and optimized PCB layout) to ensure better thermal performance and long-term reliability.

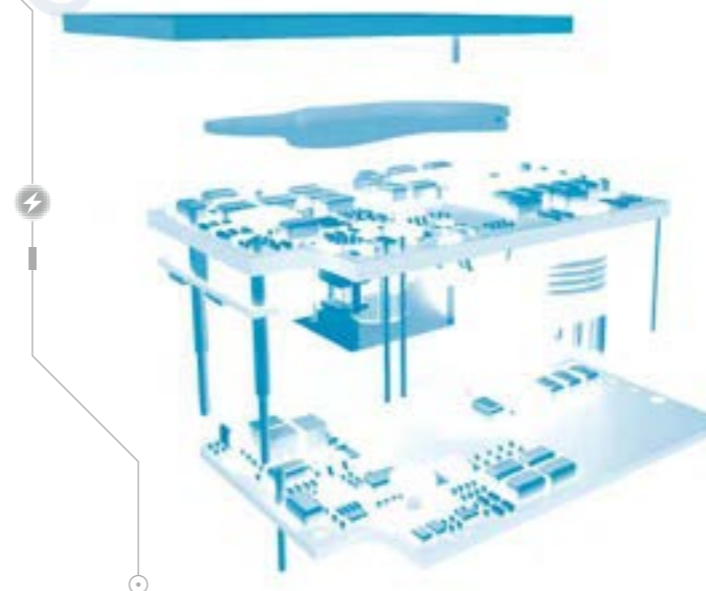

- High Thermal Conductive Adhesives
- Low Thermal Impedance Components
- Optimized PCB Layout

* Example : MRZ1150 Series

Wider Operating Temperature Range

- Wider Operating Ambient Temp. Range -40°C to +85°C
- Wider Operating Baseplate Temp. Range -40°C to +105°C
- Storage Temp. Range -50°C to +125°C
- Operating Humidity 95% rel. H

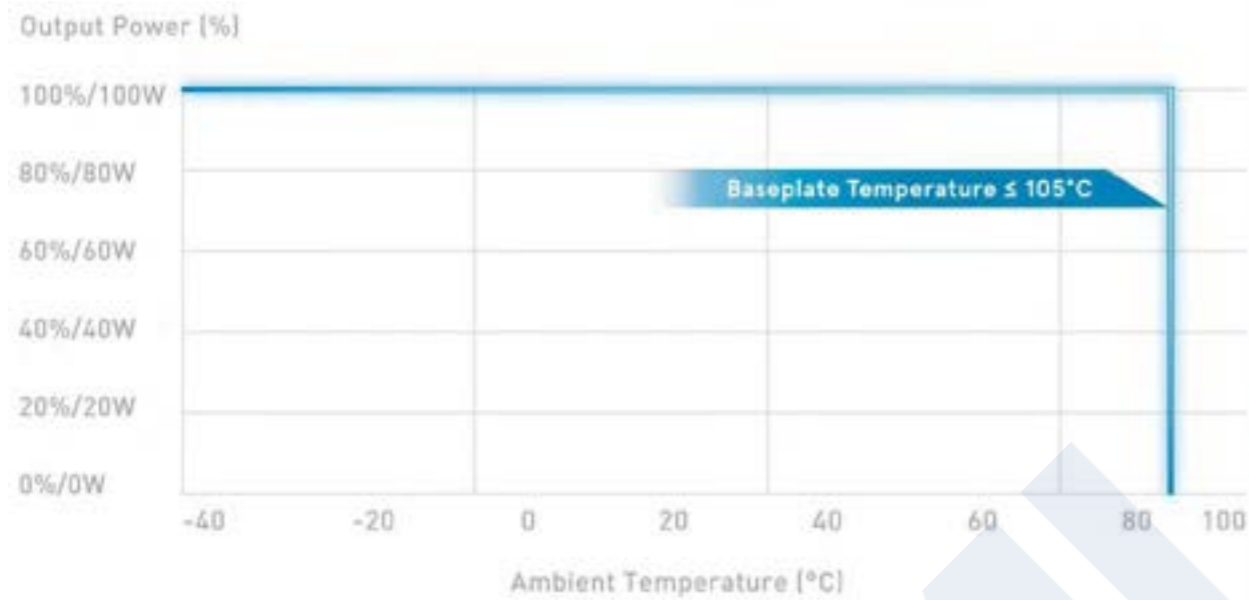

* DUT : MRZI100 Series

* Please refer to the "Environmental Requirement Test for EN 50155 Railway Certification" on Page 07-08 for more information.

Heatsink Options for Better Temperature Performance

Provide three heatsink options with different heights to meet the usage occasion with different operating temperature demand.

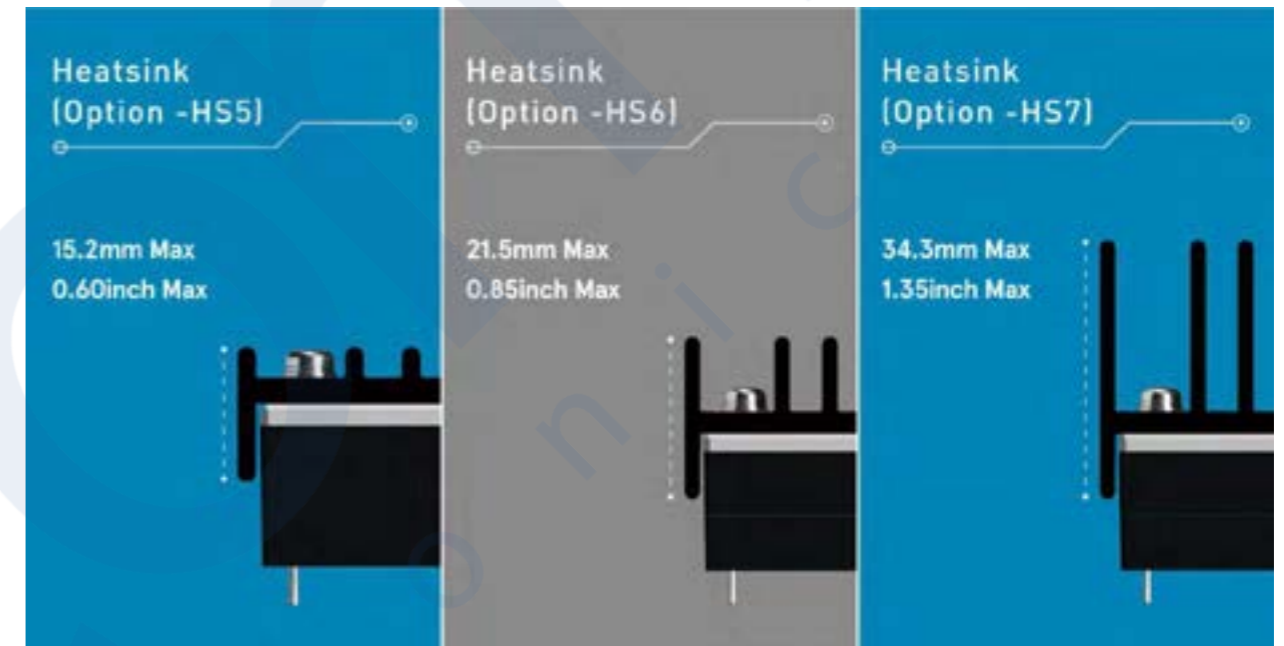

Excellent EMC Performance

Excellent EMC performance by upgraded noise filtering technology helps to improve overall system EMI performance on conduction and radiation emission & EMS performance on ESD, Surge, EFT, RS, CS and PFMP immunity.

Conduction Emission with EN 50121-3-2 Compliance

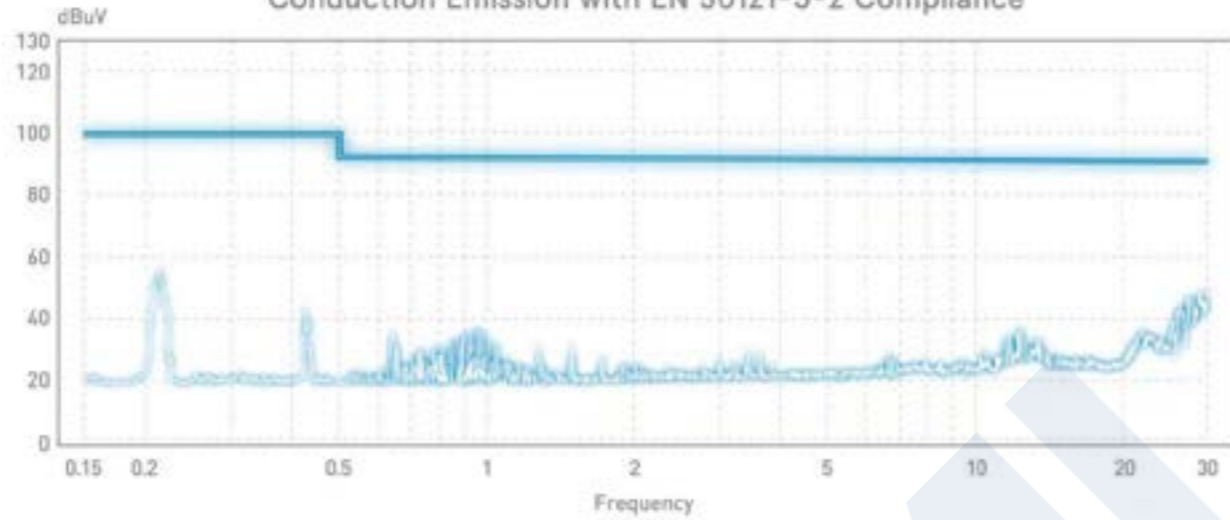

Radiation Emission with EN 50121-3-2 Compliance

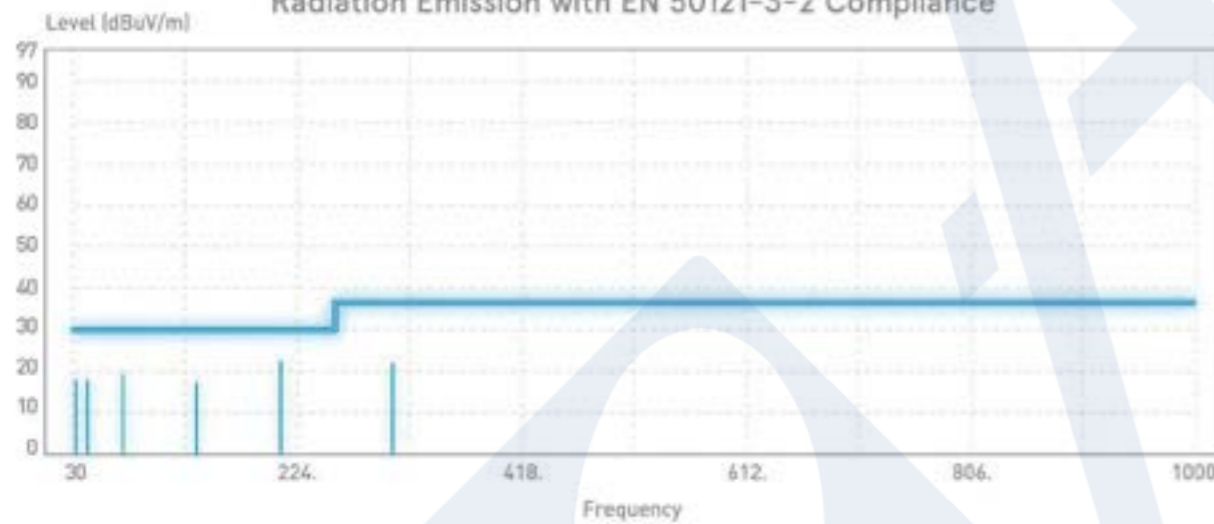

Excellent EMC Performance

Electro Magnetic Susceptibility – EFT Waveform with EN 61000-4-2

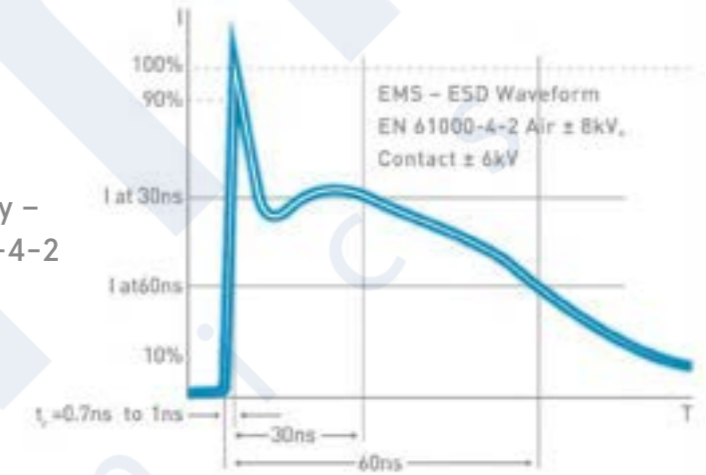

Electro Magnetic Susceptibility – EFT Waveform with EN 61000-4-4

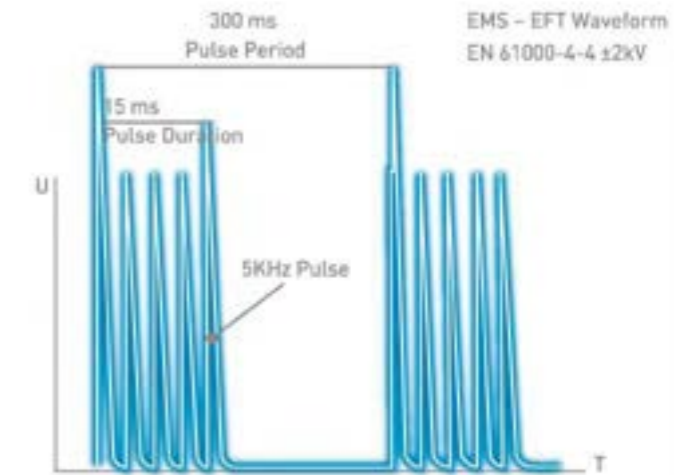

Electro Magnetic Susceptibility – EFT Waveform with EN 61000-4-5

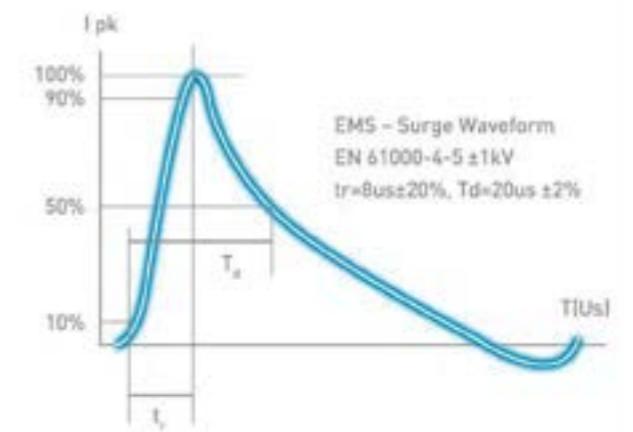

Rugged Mechanical and Thermal Impact Stress Design

Passed Environment Stress Test & Mechanical Stress Test to meet harsh environmental requirements:

- Low Temperature Start-up Test
EN 50155 13.4.4 / EN 60068-2-1
- Dry Heat Test
EN 50155 13.4.5 / EN 60068-2-2
- Low Temperature Storage Test
EN 50155 13.4.6 / EN 60068-2-1
- Cyclic Damp Heat Test
EN 50155 13.4.7 / EN 60068-2-30
- Functional Random Vibration Test
EN 50155 13.4.11 / EN 61373 (EN 60068-2-6)
- Increased Random Vibration Test
EN 50155 13.4.11 / EN 61373 (EN 60068-2-6)
- Shock Test
EN 50155 13.4.11 / EN 61373 (EN 60068-2-27)



* Please refer to the "Environmental & Mechanical Requirement Test for EN 50155 Railway Certification" on Page 07-09 for more information.

Rigorous Temperature Cycling Test

MINMAX's railway certified products have passed 500+ times the temperature cycling test at -40°C to +125°C as long-term reliability test to meet the stringent requirements of railway system.

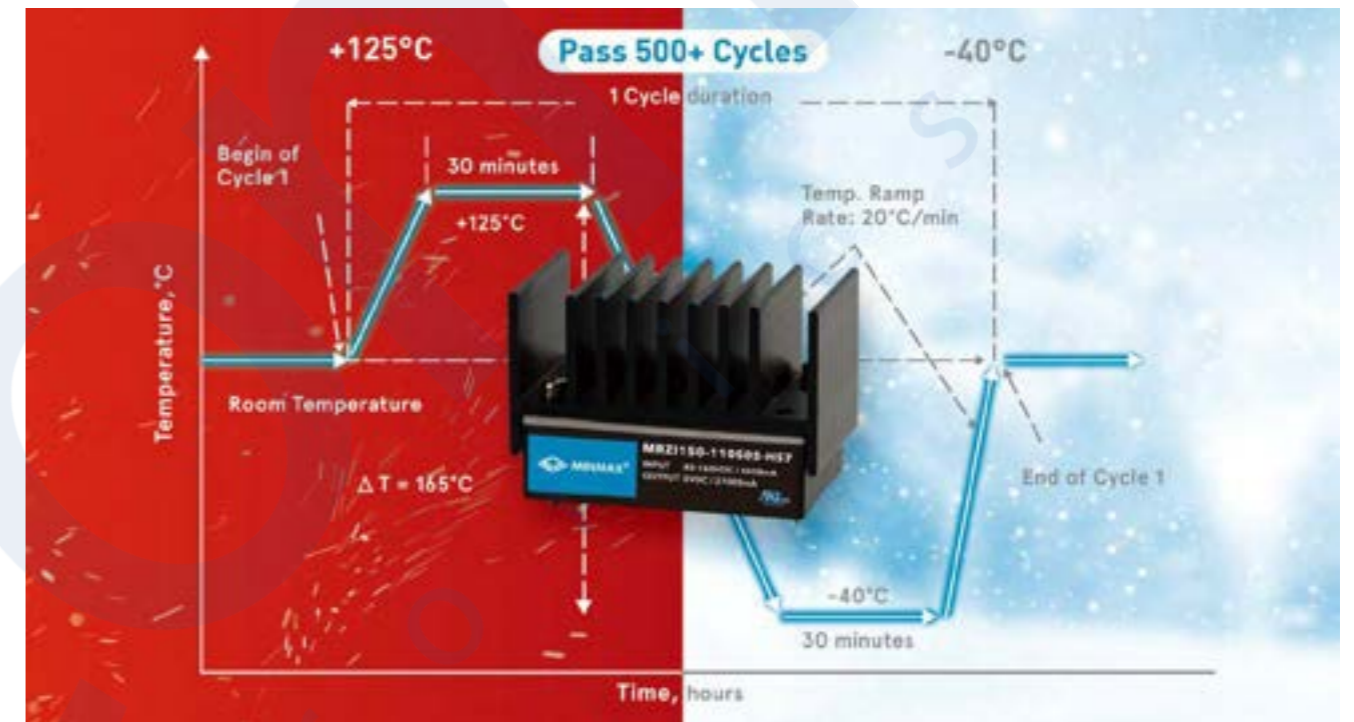

* DUT : MRZ150 Series

Altitude by 5000 Meters for Plain to Plateau Operation

- Certified by UL standards of safety to withstand an altitude of 5000m.
- Avoids short circuit development between PCB tracks, air gaps and arcing, to solve the high-altitude operation-limit issues of your system.



* DUT : MRZ150 Series

Reliability Screening Policy

- Besides EN 50155 standard, our railway DC-DC converters are tested by conscientious and reliable to provide high quality and safe products.

Testing Characteristics	Testing Condition	
Developing Product Reliability Test		
Burn-in	Input Line Output Load Temperature Duration	Nom. Line Full Load Room Temperature 1032 HRs
Highly Accelerated Life Test (HALT)	Thermal Step Stress Test Rapid Thermal Stress Test Vibration Step Stress Test Combined Environmental Stress Test	
Temperature Cycling Test (TCT)	Temperature Change Steady State Duration Ramp Rate Number of Cycles	-40°C ~ +125°C 30min 20°C/min 500+
Temperature & Humidity Storage Cycling Test (Non-Operation)	Temperature Change Ramp Rate Relative Humidity Steady State Duration Number of Cycles	Low to High Temperature 1-3°C/min +95% RH. 1 HR 5 Cycles
Power and Temperature Cycling Test (PTCT) (In Operation)	Input Line Change Output Load Change Temperature Change Relative Humidity Duration for ON/OFF Number of Cycles	Low/Nom./High Line No or Min./Full Load Low to High Temperature +95% RH. 3 Sec 300 Cycles
Temperature, Humidity and Bias Test (THB) (In Operation)	Input Line Output Load Temperature Relative Humidity Operating Duration	High Line No or Min. Load +85°C +85% RH. 1000 HRs
Low Temperature Test (In Operation)	Input Line Output Load Temperature Duration	Nom. Line Full Load Low Temperature Achieve Thermal Equilibrium
High Temperature Test (In Operation)	Input Line Output Load Temperature Duration	Nom. Line Full Load High Temperature Achieve Thermal Equilibrium
Vibration Test (Non-Operation)	Waveform	Random
	P.S.D Level	10 Hz · 1.04×10 ⁻³ g ² /Hz 30 to 200Hz · 20.8×10 ⁻³ g ² /Hz 500 Hz · 2.08×10 ⁻³ g ² /Hz
	Duration	30 minutes
	Directions	X, Y and Z
Shock Test (Operation)	Waveform Acceleration Duration Number of Shocks	Half-sine 30 g 11 ms 3 shocks for each ±axis
ESD Test	Contact Discharge Air Discharge	±4KV ±2/4/8KV
Soldering Heat Test	MIL-STD-202F Method 210E	
RoHS	RoHS Directive 2011/65/EU	
Additional Test		
Drop Test	Drop Height	66 cm
	Drop Sequence	1 corner, 3 edges and 6 faces

ECO-Techology

Green Design for Higher Full Range Efficiency

- High efficiency for whole output load, input line & ambient temp. range by latest green design technology helps to energy saving, thermal, management, minimize the temp. rise and size miniaturization.

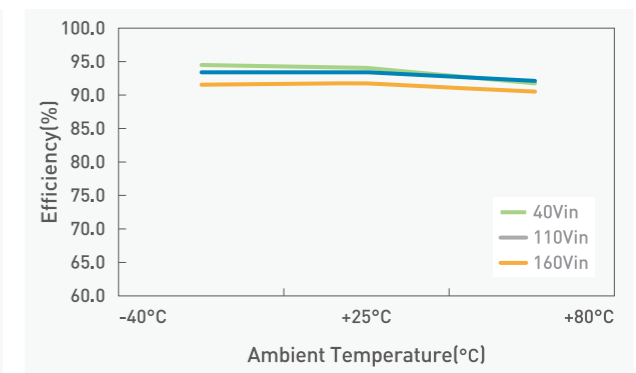
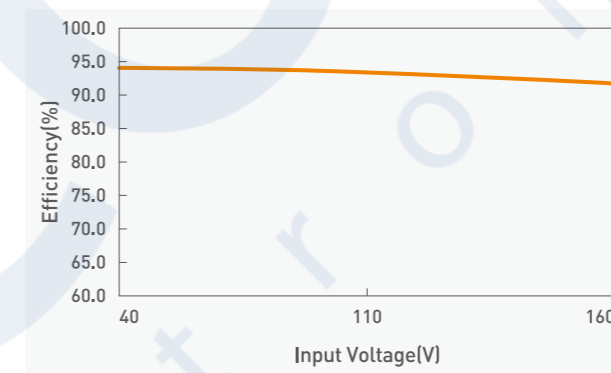
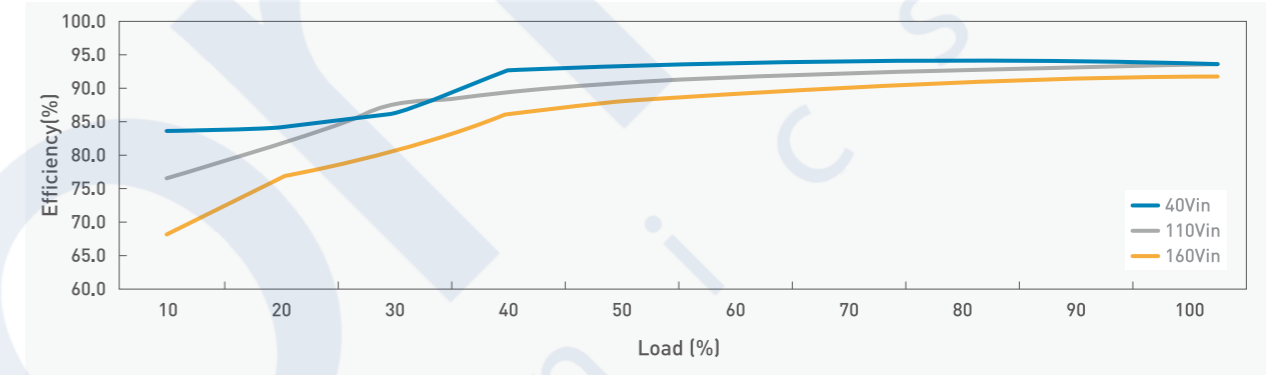

Green Design for Energy Saving & Minimize Power Dissipation

- Ultra low 0% to 100% load power consumption by latest green design technology helps to improve and minimize the temp. rise (avoid thermal problem), energy saving and prolong the battery life.

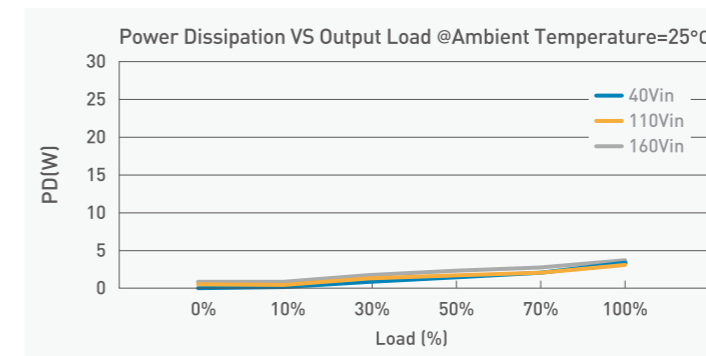

Green Design for No Min. Load / Dummy Load Requirement

- With high stability feedback loop design, the MINMAX railway certified DC-DC converters will not instable output voltage oscillation in no-load or light-load condition.



* DUT : MRZI150 Series

Faster Start-up Time without Overshoot

Fast start-up time without overshoot which help to avoid system load timing failure and ensure safety operation during start-up operation.

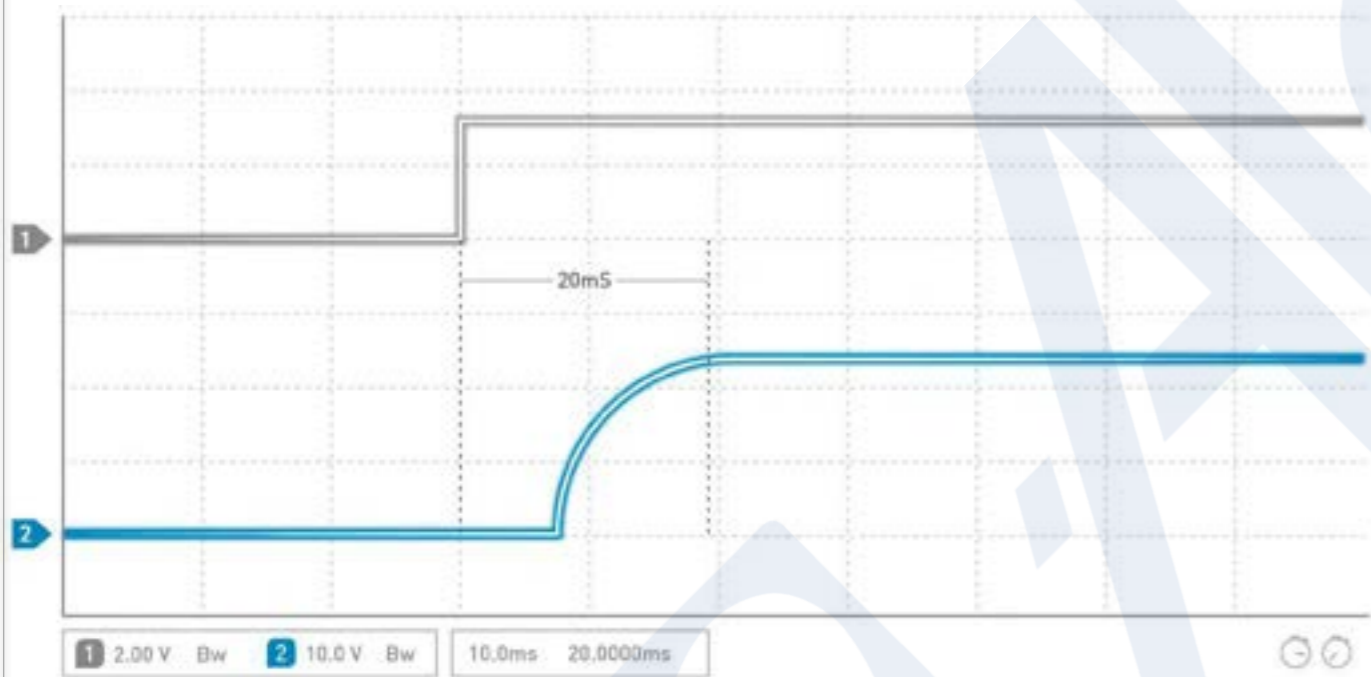

* DUT : MRZI150 Series

Superior Load Driving without Failure

The MRZI150 can support superior system load driving capability at very low or even zero voltage output without start-up failure for filed applications needed.

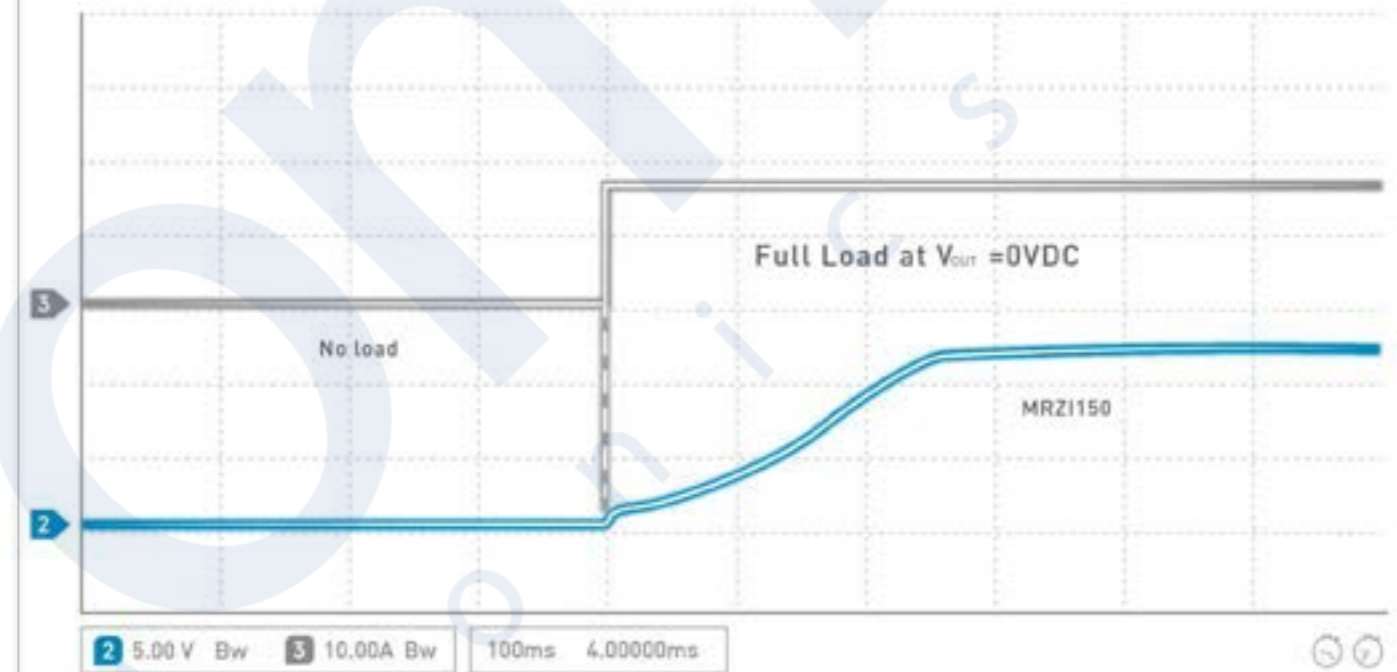

* DUT : MRZI150 Series

Lower Ripple & Noise

Through upgraded noise filtering technique, the ripple & noise of MRZI150 series keep low for whole output load, input line and ambient temp. which help to reduce the peripheral components needed and noise interference.

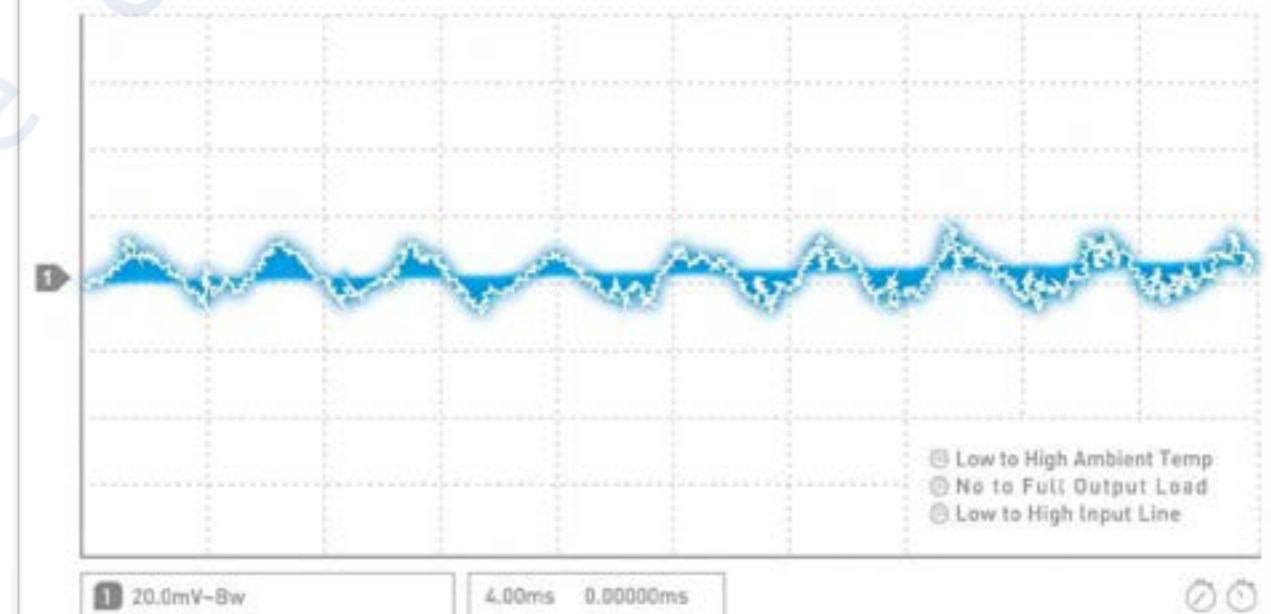

* DUT : MRZI150 Series

Multi-Protection Functions Remote ON/OFF Control & Output Voltage Trim

The MRZ1150 series is also equipped with the positive/negative remote control, output voltage trim and sensing functions to provide design flexibility for customers.

 UVP INPUT UNDER VOLTAGE PROTECTION	 POSITIVE AND NEGATIVE LOGIC REMOTE ON/OFF
 OCP OUTPUT OVER CURRENT PROTECTION	 OUTPUT VOLTAGE TRIM
 SCP OUTPUT SHORT CIRCUIT PROTECTION	 OUTPUT VOLTAGE SENSING
 OVP OUTPUT OVER VOLTAGE PROTECTION	
 OTP OVER TEMPERATURE PROTECTION	

Fully Encapsulated for Blocking Interference

For the electromagnetic susceptibility and environmental physical stress interference which are protected from a comprehensive protection capabilities.



* DUT : MRZ1150 Series
* Please refer to the "Environmental & Mechanical Requirement Test for EN 50155 Railway Certification " on Page 07-09 for more information.

Fire Protection Test to Save Your System

The following index parameters are used to evaluate fire protection capabilities:

Fire protection grades (HL Level) of all plastic housings, printed circuit boards (PCB), and potting compounds of all MINMAX's railway certified power modules will be evaluated based on the final test results of the "fire safety index parameter" to ensure safety during railway/railroad vehicle operation.



* Please refer to the "Fire Protection Test of the EN 45545-2 Standard" on Page 10 for more information.

Certifications

- ✓ Railway Certified EN 50155 (IEC 60571) Approved
- ✓ Fire Protection Test EN 45545-2 Approved
- ✓ Vibration and Shock Test EN 61373 Approved
- ✓ Cooling, Dry & Damp Heat Test IEC/EC 60068-2-1, 2, 30 Approved
- ✓ Railway EMC Standard EN 50121-3-2 Approved
- ✓ CE Marking
- ✓ UL/cUL/IEC/EN 62368-1(60950-1) Approved



SUCCESSFUL APPLICATION

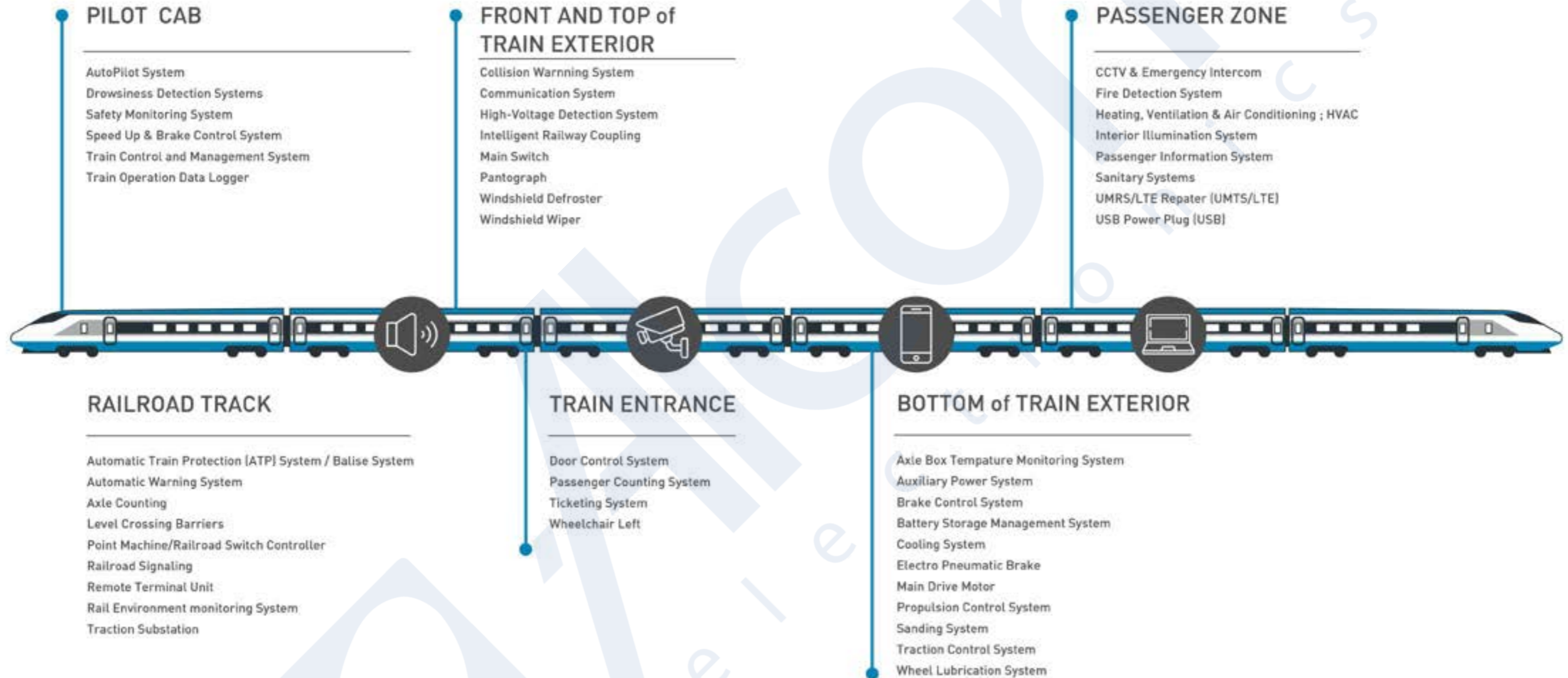

RAILWAY CERTIFIED PRODUCTS OVERVIEW

Series	Output Power	Input Voltage Range (VDC)	Output Voltage (VDC)	Isolation (VDC)	Efficiency	Operating Ambient Temp. Range ⁽¹⁾	No Min. Load	OCP/SCP	OVP	OTP	Remote ON/OFF Control	Output Voltage Trim	Output Sense	EN50155 (IEC60571)	UL/cUL/IEC/EN 62368-1
3W • DIP Package															
MIZI03	3W	9-36 18-75 40-160	5, 12, 15, ±12, ±15	3000VAC Reinforced	85%	-40~+92°C Ambient	•	•						•	•
10-40W • 2" x 1" Package															
MKZI10	10W	9-36 18-75 40-160	5, 12, 15, 24, ±12, ±15	3000VAC Reinforced	89%	-40~+95°C Ambient	•	•	•		•	•		•	•
MKZI20	20W	9-36 18-75 40-160	5, 12, 15, 24, ±12, ±15	3000VAC Reinforced	88%	-40~+88.5°C Ambient	•	•	•		•	•		•	•
NEW MKZI40	40W	36-160	5, 12, 15, 24, 54, ±12, ±15	3000VAC Reinforced	90%	-40~+77.5°C Ambient	•	•	•	•	•	•		•	•
50-150W • Quarter Brick															
MTQZ50	50W	43-101 66-160	5, 12, 15, 24,	3000VAC Reinforced	92%	-40~+85°C Ambient	•	•	•	•	•	•	•	•	•
NEW MRZI75	75W	36-160 ⁽²⁾	5, 12, 15, 24, 54	2000VAC Reinforced	91%	-40~+105°C Base plate	•	•	•	•	•	•	•	•	•
NEW MRZI100	100W	36-160 ⁽²⁾	5, 12, 15, 24, 54	2000VAC Reinforced	91.5%	-40~+105°C Base plate	•	•	•	•	•	•	•	•	•
NEW MRZI150	150W	36-160 ⁽²⁾	5, 12, 15, 24, 54	2000VAC Reinforced	90%	-40~+105°C Base plate	•	•	•	•	•	•	•	•	•

⁽¹⁾ Please refer to derating curve information form datasheet
⁽²⁾ Please refer to star-up voltage information form datasheet

RAILWAY CERTIFIED • DC-DC CONVERTERS

3W MIZI03 Series DIP Package



Model Selection Guide				
Model Number	Input Voltage (VDC)	Output Voltage (VDC)	Output Current (mA)max	Efficiency
MIZI03-24S05	24 (9 - 36)	5	600	80%
MIZI03-24S12		12	250	84%
MIZI03-24S15		15	200	85%
MIZI03-24D12		±12	±125	83%
MIZI03-24D15		±15	±100	84%
MIZI03-48S05	48 (18 - 75)	5	600	80%
MIZI03-48S12		12	250	83%
MIZI03-48S15		15	200	84%
MIZI03-48D12		±12	±125	83%
MIZI03-48D15		±15	±100	83%
MIZI03-110S05	100 (40 - 160)	5	600	80%
MIZI03-110S12		12	250	84%
MIZI03-110S15		15	200	84%
MIZI03-110D12		±12	±125	83%
MIZI03-110D15		±15	±100	85%

10W MKZI10 Series 2" x 1" Package



Model Selection Guide				
Model Number	Input Voltage (VDC)	Output Voltage (VDC)	Output Current (mA)max	Efficiency
MKZI10-24S05	24 (9 - 36)	5	2000	84%
MKZI10-24S12		12	835	86%
MKZI10-24S15		15	670	87%
MKZI10-24S24		24	417	88%
MKZI10-24D12		±12	±417	86%
MKZI10-24D15	±15	±335	87%	
MKZI10-48S05	48 (18 - 75)	5	2000	85%
MKZI10-48S12		12	835	87%
MKZI10-48S15		15	670	87%
MKZI10-48S24		24	417	86%
MKZI10-48D12		±12	±417	89%
MKZI10-48D15	±15	±335	88%	
MKZI10-110S05	100 (40 - 160)	5	2000	82%
MKZI10-110S12		12	835	85%
MKZI10-110S15		15	670	85%
MKZI10-110S24		24	417	85%
MKZI10-110D12		±12	±417	86%
MKZI10-110D15	±15	±335	86%	

*There are different features & spec. by each series.
 For detailed series datasheet, please refer to www.minmaxpower.com

RAILWAY CERTIFIED • DC-DC CONVERTERS

20W MKZI20 Series 2" x1" Package



Model Selection Guide				
Model Number	Input Voltage (VDC)	Output Voltage (VDC)	Output Current (mA)max	Efficiency
MKZI20-24S05	24 (9 - 36)	5	4000	87%
MKZI20-24S12		12	1670	87%
MKZI20-24S15		15	1330	87%
MKZI20-24S24		24	833	87%
MKZI20-24D12		±12	±833	86%
MKZI20-24D15		±15	±667	86%
MKZI20-48S05	48 (18 - 75)	5	4000	87%
MKZI20-48S12		12	1670	88%
MKZI20-48S15		15	1330	88%
MKZI20-48S24		24	833	88%
MKZI20-48D12		±12	±833	87%
MKZI20-48D15		±15	±667	87%
MKZI20-110S05	100 (40 - 160)	5	4000	84%
MKZI20-110S12		12	1670	86%
MKZI20-110S15		15	1330	86%
MKZI20-110S24		24	833	86%
MKZI20-110D12		±12	±833	86%
MKZI20-110D15		±15	±667	86%

40W MKZI40 Series 2" x1" Package NEW



Model Selection Guide				
Model Number	Input Voltage (VDC)	Output Voltage (VDC)	Output Current (mA)max	Efficiency
MKZI40-110S05	110 (36 - 160)	5	8000	88%
MKZI40-110S12		12	3330	89%
MKZI40-110S15		15	2670	89%
MKZI40-110S24		24	1670	89%
MKZI40-110S54		54	741	90%
MKZI40-110D12		±12	±1670	89%
MKZI40-110D15	±15	±1330	89%	

*There are different features & spec. by each series.
For detailed series datasheet, please refer to www.minmaxpower.com

RAILWAY CERTIFIED • DC-DC CONVERTERS

50W MTQZ50 Series Quarter Brick Package



Model Selection Guide					
Model Number	Input Voltage (VDC)	Output Voltage (VDC)	Output Current (mA)max	Efficiency	
MTQZ50-72S05	72 (43 - 101)	5	10000	90%	
MTQZ50-72S12		12	4170	92%	
MTQZ50-72S15		15	3330	92%	
MTQZ50-72S24		24	2080	91%	
MTQZ50-110S05		110 (66 - 160)	5	10000	90%
MTQZ50-110S12			12	4170	91%
MTQZ50-110S15	15		3330	92%	
MTQZ50-110S24	24		2080	91%	

75W MRZI75 Series Quarter Brick Package NEW



Model Selection Guide				
Model Number	Input Voltage (VDC)	Output Voltage (VDC)	Output Current (mA)max	Efficiency
MRZI75-110S05	110 (36 - 160)	5	15000	89%
MRZI75-110S12		12	6250	91%
MRZI75-110S15		15	5000	91%
MRZI75-110S24		24	3125	90%
MRZI75-110S54		54	1390	89%

*There are different features & spec. by each series.
For detailed series datasheet, please refer to www.minmaxpower.com

RAILWAY CERTIFIED • DC-DC CONVERTERS

100W MRZI100 Series NEW Quarter Brick Package



Model Selection Guide				
Model Number	Input Voltage (VDC)	Output Voltage (VDC)	Output Current (mA)max	Efficiency
MRZI100-110S05	110 (36 - 160)	5	20000	91.5%
MRZI100-110S12		12	8400	91%
MRZI100-110S15		15	6700	90.5%
MRZI100-110S24		24	4200	89%
MRZI100-110S54		54	1850	89%

150W MRZI150 Series NEW Quarter Brick Package



Model Selection Guide				
Model Number	Input Voltage (VDC)	Output Voltage (VDC)	Output Current (mA)max	Efficiency
MRZI150-110S05	110 (36 - 160)	5	27000	90%
MRZI150-110S12		12	12500	90%
MRZI150-110S15		15	10000	89%
MRZI150-110S24		24	6250	88%
MRZI150-110S54		54	2780	88.5%

*There are different features & spec. by each series.
For detailed series datasheet, please refer to www.minmaxpower.com

MINMAX POWER SOLUTIONS DC-DC CONVERTERS · AC-DC POWER SUPPLIES | 1-150W



GENERAL INDUSTRIAL

• DC-DC CONVERTERS

<p>SIP Package</p> <p>1-5W</p>	<p>SMD Package</p> <p>1-6W</p>	<p>DIP Package</p> <p>1-15W</p>
<p>1"×1" Package</p> <p>10-30W</p>	<p>2"×1" Package</p> <p>40-50W</p>	<p>Chassis & DIN-Rail Mounting</p> <p>6-60W</p>

• AC-DC POWER SUPPLIES

<p>Encapsulated Package</p> <p>3-60W</p>
--



RAILWAY CERTIFIED

• DC-DC CONVERTERS

<p>DIP Package</p> <p>3W</p>	<p>2"×1" Package</p> <p>10-40W</p>	<p>Quarter Brick</p> <p>50-150W</p>
------------------------------	------------------------------------	-------------------------------------

MINMAX POWER SOLUTIONS DC-DC CONVERTERS · AC-DC POWER SUPPLIES | 1-150W



ULTRA-HIGH ISOLATION

• DC-DC CONVERTERS

<p>SIP Package</p> <p>1-2W</p>	<p>SMD Package</p> <p>1W</p>	<p>DIP Package</p> <p>2-10W</p>
<p>2"×1" Package</p> <p>15-20W</p>	<p>Chassis & DIN-Rail Mounting</p> <p>6-60W</p>	

• DC-DC CONVERTERS

<p>SIP Package</p> <p>1W</p>	<p>SMD Package</p> <p>1-2W</p>
<p>DIP Package</p> <p>2-10W</p>	<p>2"×1" Package</p> <p>15-20W</p>

• AC-DC POWER SUPPLIES

<p>Encapsulated Package</p> <p>24-60W</p>

POWER FOR
A BETTER FUTURE

FOR MORE INFO, PLEASE GO TO  www.minimaxpower.com



Singel 3 | B-2550 Kontich | Belgium | Tel. +32 (0)3 458 30 33 | info@alcom.be | www.alcom.be
Rivium 1e straat 52 | 2909 LE Capelle aan den IJssel | The Netherlands | Tel. +31 (0)10 288 25 00 | info@alcom.nl | www.alcom.nl