

Ultra High-Performance

3030 Mid Power LED (65mA, 3V)



Flip Chip

Table of Contents

Technology Overview	2
Product Selection Table	3
Operating Characteristics	4
Chromaticity Diagram	5
Color Ranks	5
Chromaticity Coordinate Group	6
Characteristics Graphs	7
Solder Profile	8
Ordering Nomenclature	9
Package dimension	10
Soldering Pad Pattern	10
Dimension and Polarity	11
Package Dimensions	12
Box Packaging	13

Features:

- High efficacy
- CRI Options: Minimum 80, 90, 95
- Low thermal resistance
- Compatible with automatic placement equipment
- Compatible with infrared reflow solder process
- Sulfur resistant
- RoHs and REACH compliant

Applications

- Replacement lamps
- Panel lighting
- Down lights
- Horticulture

Technology Overview

Luminus mid power LEDs are lighting class solutions designed for high performance general lighting applications. These state-of-the-art LEDs allow illumination engineers and designers to develop lighting solutions with maximum efficacy, brightness and overall quality.

Reliability

Luminus mid power LED is one of the most reliable light sources in the world today. Having passed a rigorous suite of environmental and mechanical stress tests, including mechanical shock, vibration, temperature cycling and humidity, it is fully qualified for use in a wide range of high performance and high efficacy lighting applications.

REACH & RoHS Compliance

The Luminus MP-3030 Mid Power LED is compliant to the Restriction of Hazardous Substances Directive or RoHS.

Understanding Luminus Mid Power LED Test Specifications

Every Luminus LED is fully tested to ensure it meets the high quality standards customers have come to expect from Luminus products.

Testing Temperature

Luminus Mid Power products are measured at a case temperature of 25°C and placed into intensity, chromaticity and voltage bins as described herein.

Product Selection Table

Test condition = 65 mA, T_c=25 °C

Nominal CCT	Minimum CRI	Ordering Part Number	Minimum Flux @ 65mA (Lumens)	Typical Flux @65mA (Lumens)	Typical PPF (umol/s)	Typical PPF/W (umol/J)
2200K	80	MP-3030-110F-22-80	27	29		
	90	MP-3030-110F-22-90	25	26		
2700K	80	MP-3030-110F-27-80	33	34.5	0.49	2.80
	90	MP-3030-110F-27-90	27	29		
	95	MP-3030-110F-27-95	23	26		
3000K	80	MP-3030-110F-30-80	34	36.5	0.52	2.96
	90	MP-3030-110F-30-90	29	31		
	95	MP-3030-110F-30-95	25	27		
3500K	80	MP-3030-110F-35-80	34	36	0.53	3.05
	90	MP-3030-110F-35-90	29	31		
	95	MP-3030-110F-35-95	25	28		
4000K	80	MP-3030-110F-40-80	36	38	0.55	3.14
	90	MP-3030-110F-40-90	31	33		
	95	MP-3030-110F-40-95	27	29		
5000K	80	MP-3030-110F-50-80	37	38	0.55	3.14
	90	MP-3030-110F-50-90	31	33		
5700K	80	MP-3030-110F-57-80	37	38	0.54	3.10
	90	MP-3030-110F-57-90	31	33		
	95	MP-3030-110F-57-95	27	29		
6500K	80	MP-3030-110F-65-80	37	38	0.54	3.10
	90	MP-3030-110F-65-90	31	33		

*Tolerance of measurements of the luminous flux is ±7%

* Tolerance of measurements of the CRI is ±2

*IFP condition with Pulse: Width ≤100µs Duty cycle ≤1/10

MP-3030 Mid Power Operating Characteristics

Optical and Electrical Characteristics ($T_c=25^\circ\text{C}$)

Parameter	Symbol	Minimum	Typical	Maximum	Unit	Condition
Forward Voltage	V_f	2.6	2.7	2.8	V	$I_f=65\text{mA}$
Reverse Current	I_r			10	μA	$V_r=5\text{V}$
View Angle	$2\theta^{1/2}$		120		$^\circ$	$I_f=65\text{mA}$
Thermal Resistance	R_{th}_{j-sp}		10		$^\circ\text{C/W}$	$I_f=65\text{mA}$
Electrostatic Discharge	ESD	8000			V	

Note 1: To prevent damage refer to operating conditions and derating curves for appropriate maximum operating conditions

Note 2: Maximum operating case temperature combined with maximum drive current defines the total maximum operating condition for the device. To prevent damage, please follow derating curves for all operating conditions.

Note 3: Mid power LEDs are designed for operation up to an absolute maximum forward drive current as specified above. Product lifetime data is specified at typical forward drive currents. Sustained operation at absolute maximum currents will result in a reduction of device lifetime compared to typical forward drive currents. Actual device lifetimes will also depend on case temperature. Refer to the current vs. case temperature derating curves for further information.

Note 4: Caution must be taken not to stare at the light emitted from these LEDs. Under special circumstances, the high intensity could damage the eye.

Absolute Maximum Ratings ($T_c=25^\circ\text{C}$)

Parameter	Symbol	Rating	Unit
Forward Current	I_f	400	mA
Pulse Forward Current	I_{fp}	600	mA
Power Dissipation	P_d	1160	mW
Reverse Voltage	V_r	5	V
Operating Temperature	T_{opr}	-40~+85	$^\circ\text{C}$
Storage Temperature	T_{sta}	-40~+85	$^\circ\text{C}$
Junction Temperature	T_j	125	$^\circ\text{C}$
Soldering Temperature	T_{sld}	Reflow Soldering: 205°C for 10sec	

*IFP condition with Pulse: Width $\leq 100\mu\text{s}$ Duty cycle $\leq 1/10$

Color Bins target chromaticity @ $T_c=25\text{ }^\circ\text{C}$

Color Code	Center		Radius		Angle(deg)
	x	y	a	b	Φ
22M5	0.5065	0.4171	0.012500	0.007000	53.00
27M5	0.4582	0.4099	0.013500	0.007000	53.42
30M5	0.4342	0.4028	0.013900	0.006800	53.13
35M5	0.4080	0.3916	0.015450	0.006900	54.00
40M5	0.3825	0.3798	0.015650	0.006700	53.43
50M5	0.3451	0.3554	0.013700	0.005900	59.37
57M5	0.3290	0.3417	0.011175	0.005500	58.35
65M5	0.3130	0.3290	0.011150	0.004750	58.34

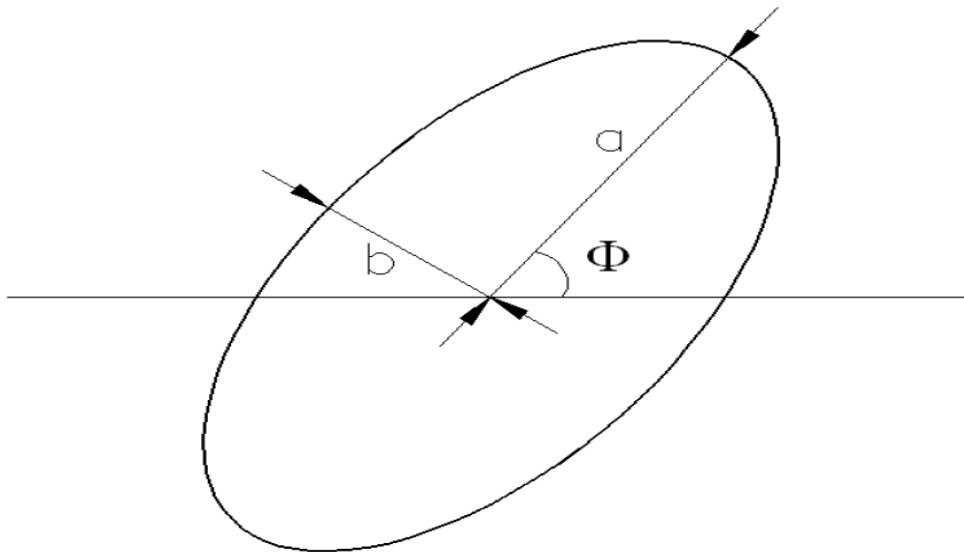
Ellipse Definition

*Note: Tolerance of measurements of the chromaticity Coordinate is ± 0.005
Chromaticity coordinates as per ANSI standard.

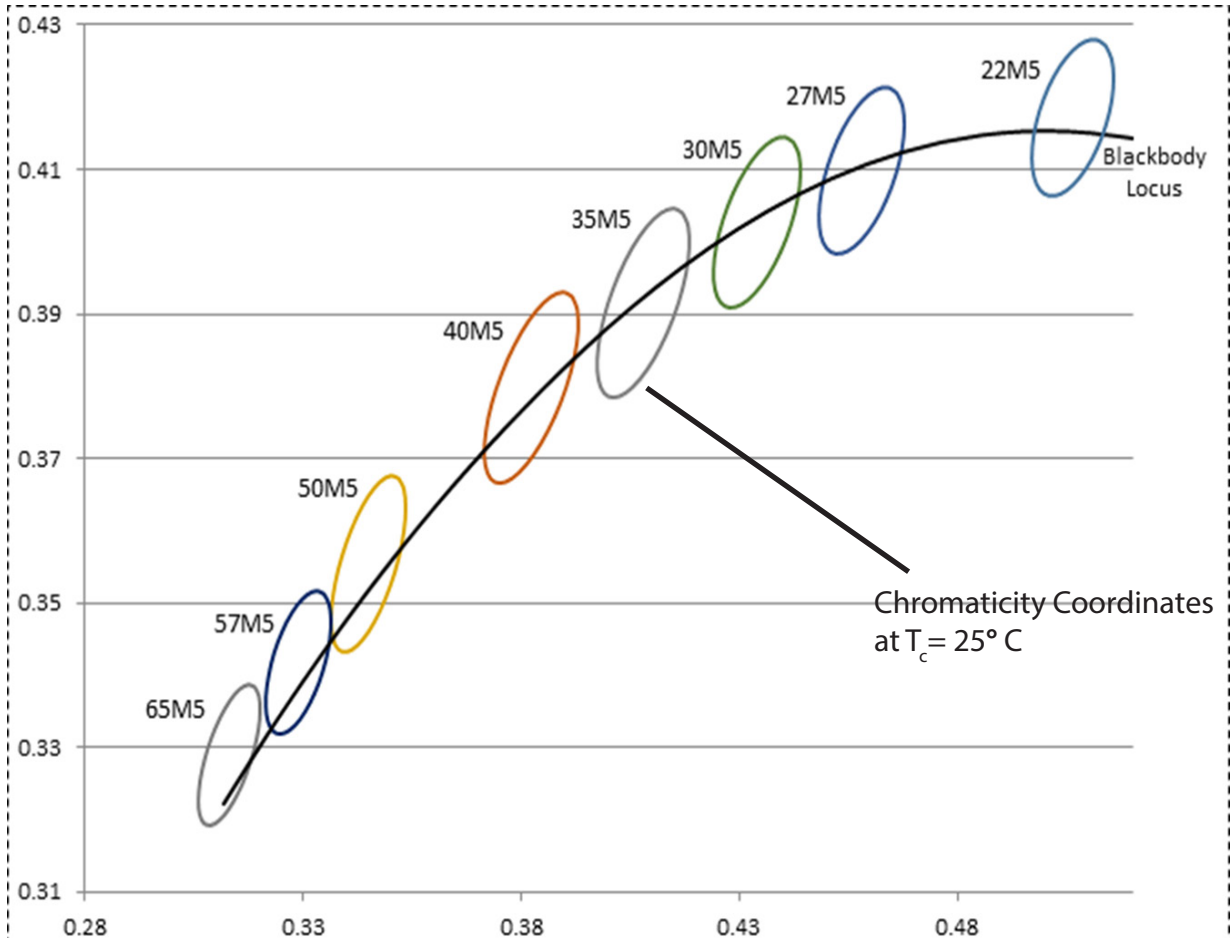
Chromaticity Coordinate Group

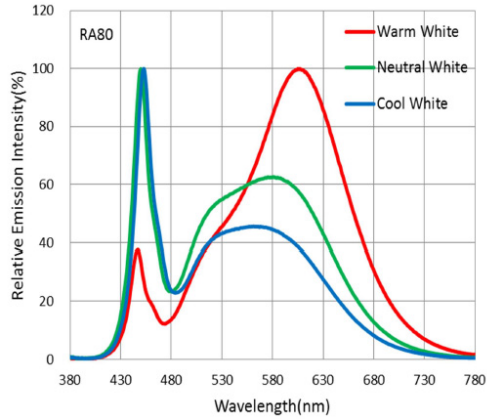
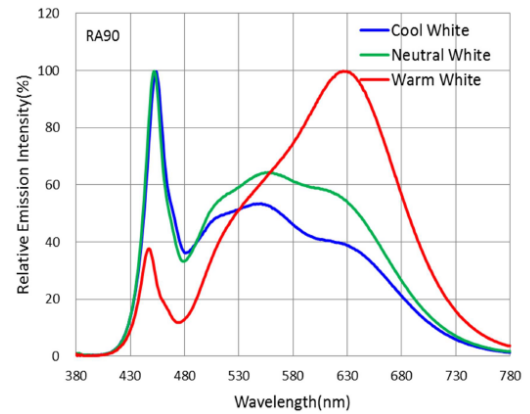
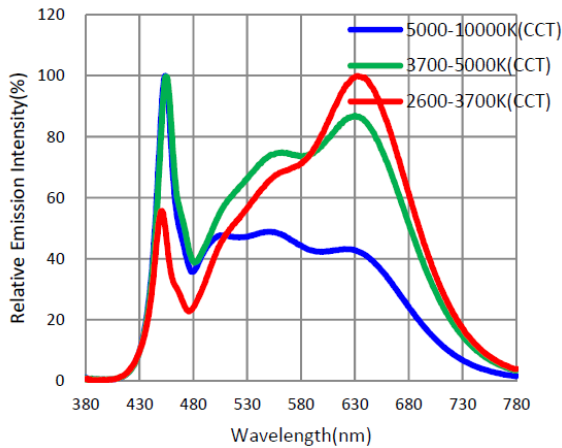
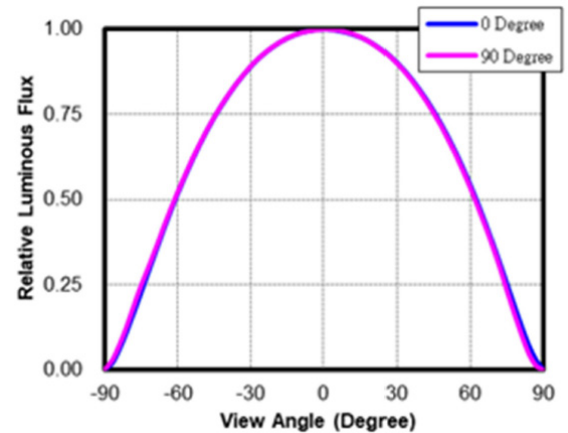
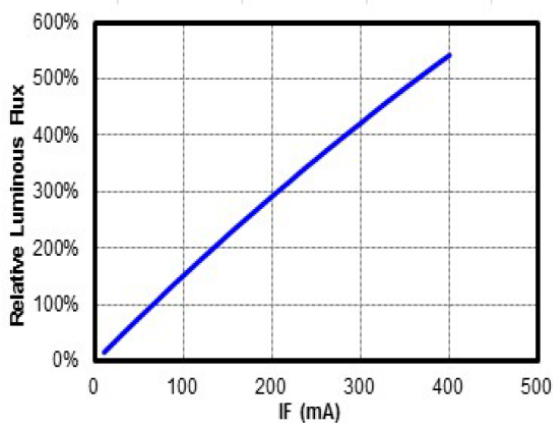
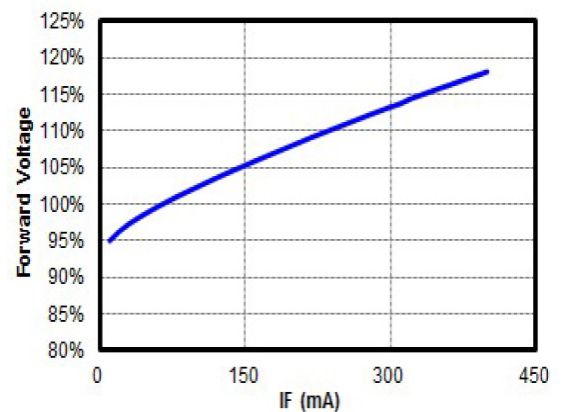
Typical optical/Electrical Characteristics Graphs
Color Spectrum (T_j = 25°C Ra ≥ 80)

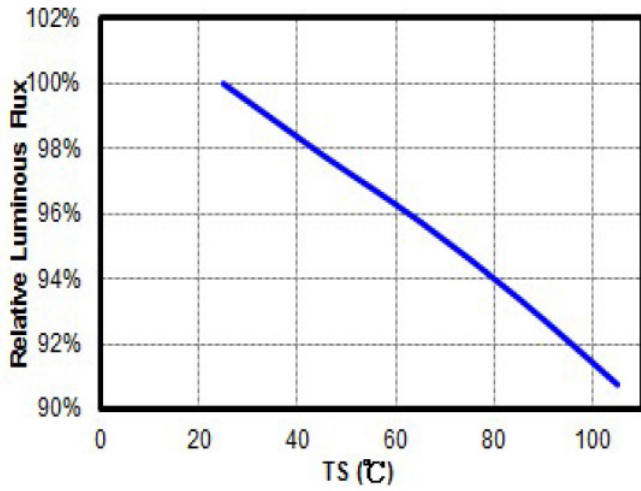
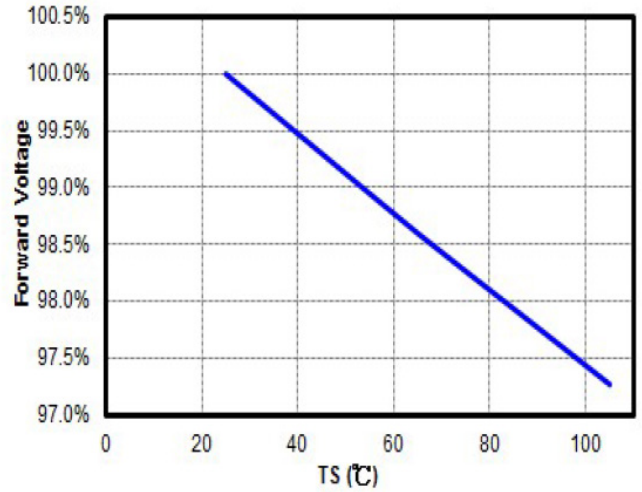
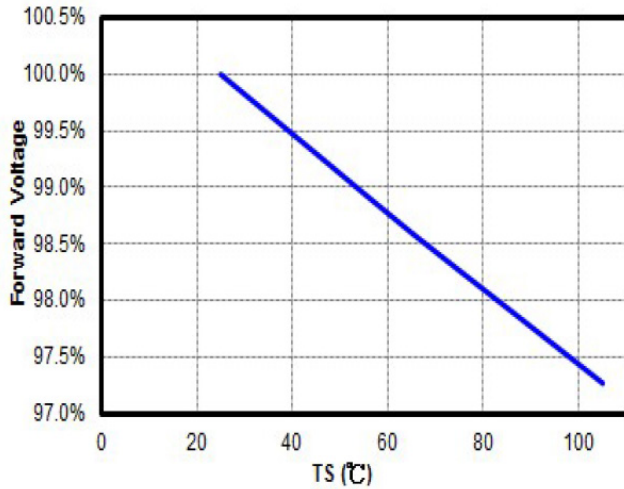
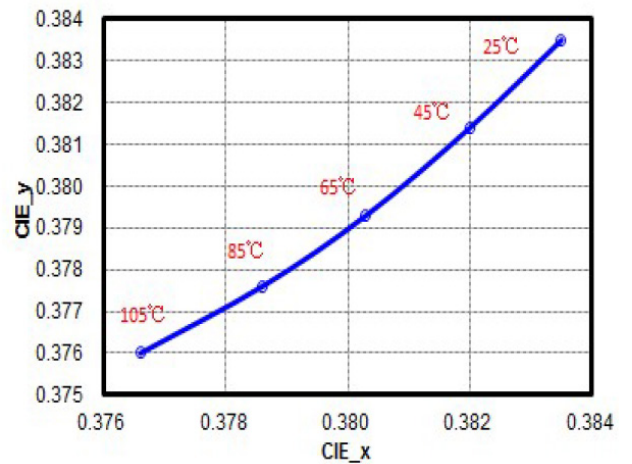
Color Spectrum (T_j = 25°C Ra ≥ 90)

Color Spectrum (T_j = 25°C Ra ≥ 95)

Viewing Angle Distribution (T_j = 25°C)

Forward Current vs. Relative Intensity (T_j = 25°C)

Forward Current vs. Forward Voltage (T_j = 25°C)

Typical Optical/Electrical Characteristic
Solder Point Temp. vs. Relative Luminous Flux

Solder Point Temp. vs. Relative Forward Voltage

T_s--Forward Voltage

T_a C_s C_{iE} x, y Shift

Product Ordering and Shipping Part Number Nomenclature

All mid power products are packaged and labeled with part numbers as outlined in below. When shipped, each reel will contain only a single flux and voltage bin. The part number designation is as follows:

MP-3030 Mid Power LEDs

Mid Power	Package Type	Package Configurator	Nominal CCT	Minimum CRI
MP	MP-3030	110F	##	##

Example:

The part number MP-3030-110F-30-80 refers to a MP-3030 mid power emitter with nominal color temperature of 3,000k and minimum CRI of 80. Please refer to page 5 for a description of available CCT and CRI combinations.

Note 1: CCT Codes:

Note 2: CRI Codes:

27 = 2700 k

30 = 3000 k

40 = 4000 k

50 = 5000 k

57 = 5700 k

65 = 6500 k

80

90

95

Each mid power product shipped will be labeled with its specific flux and voltage bins. Not all bins listed are available in all CCTs and CRIs. Test Condition = 65mA $T_c = 25^\circ\text{C}$

Luminus Flux Bins

Bin Code	Minimum Flux (Lumens)	Maximum Flux (Lumens)
D4	22	24
D5	24	26
D6	26	28
D7	28	30
D8	30	32
D9	32	34
E1	34	36
E2	36	38
E3	38	42

Forward Voltage Bins ($T_c = 25^\circ\text{C}$)

Bin Code	Minimum Voltage (Volts)	Maximum Voltage (Volts)
Y1	2.5	2.6
Z1	2.6	2.7
A1	2.7	2.8

*Tolerance of measurements of the Forward Voltage is $\pm 0.08\text{V}$

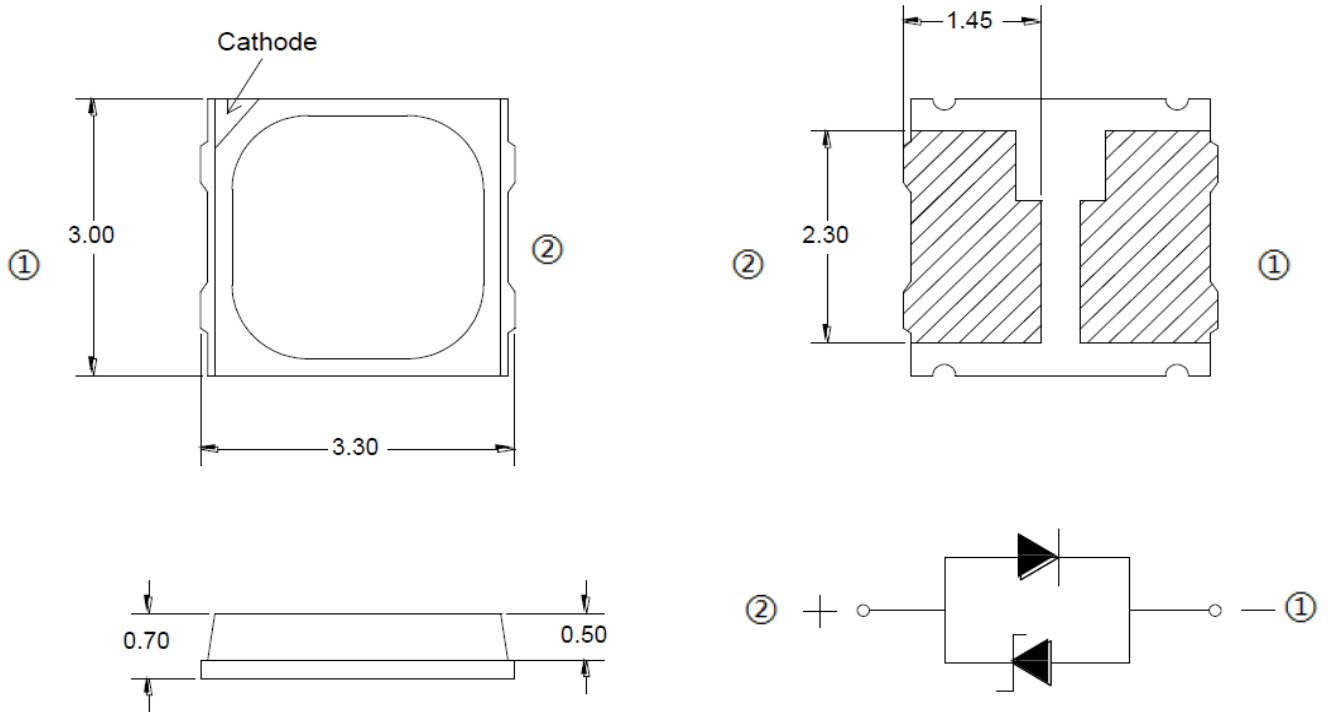
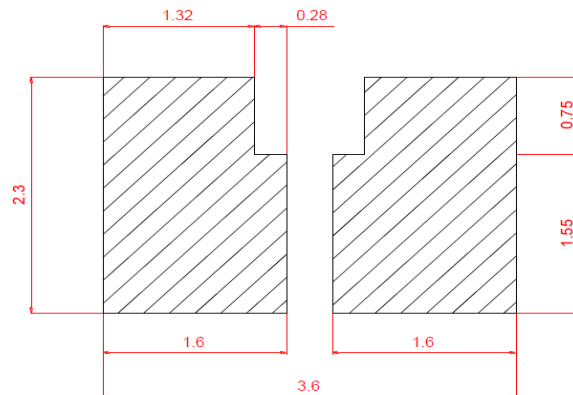
Package Dimension (mm)
Package Dimensions

Recommended Solder Pad

- *All dimensions are in millimeters
- *Scale : 1:1
- *This drawing without tolerances are for reference only
- *Undefined tolerance: $\pm 0.10\text{mm}$

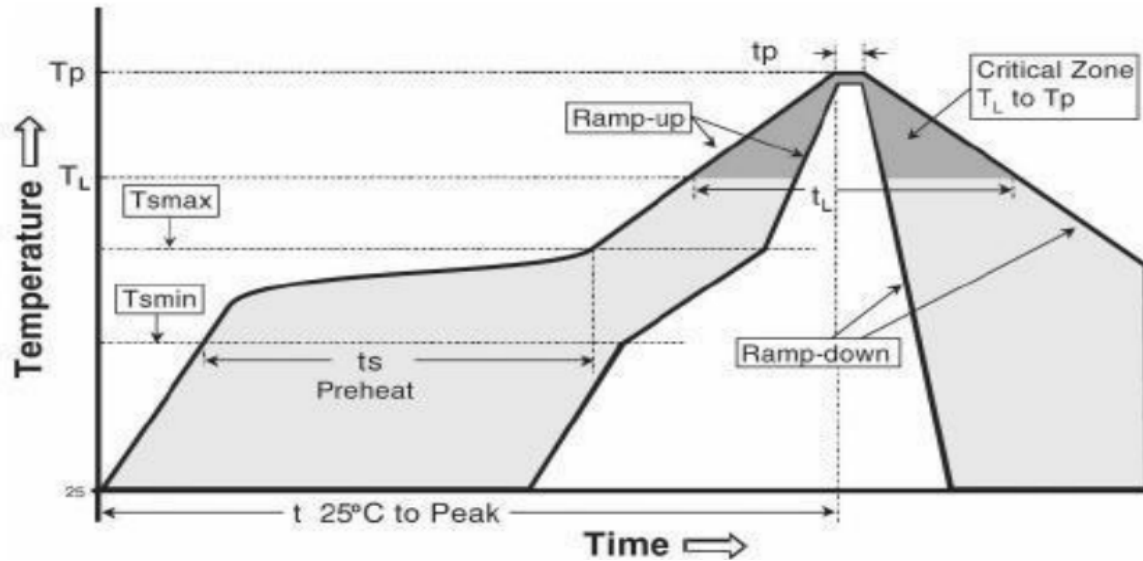
Note: tolerance : .X: $\pm 0.10\text{mm}$.XX: $\pm 0.05\text{mm}$

Reflow Soldering Characteristics

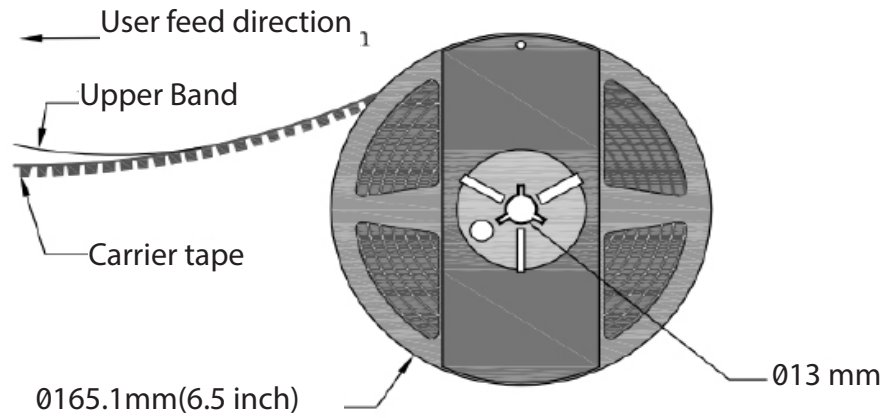
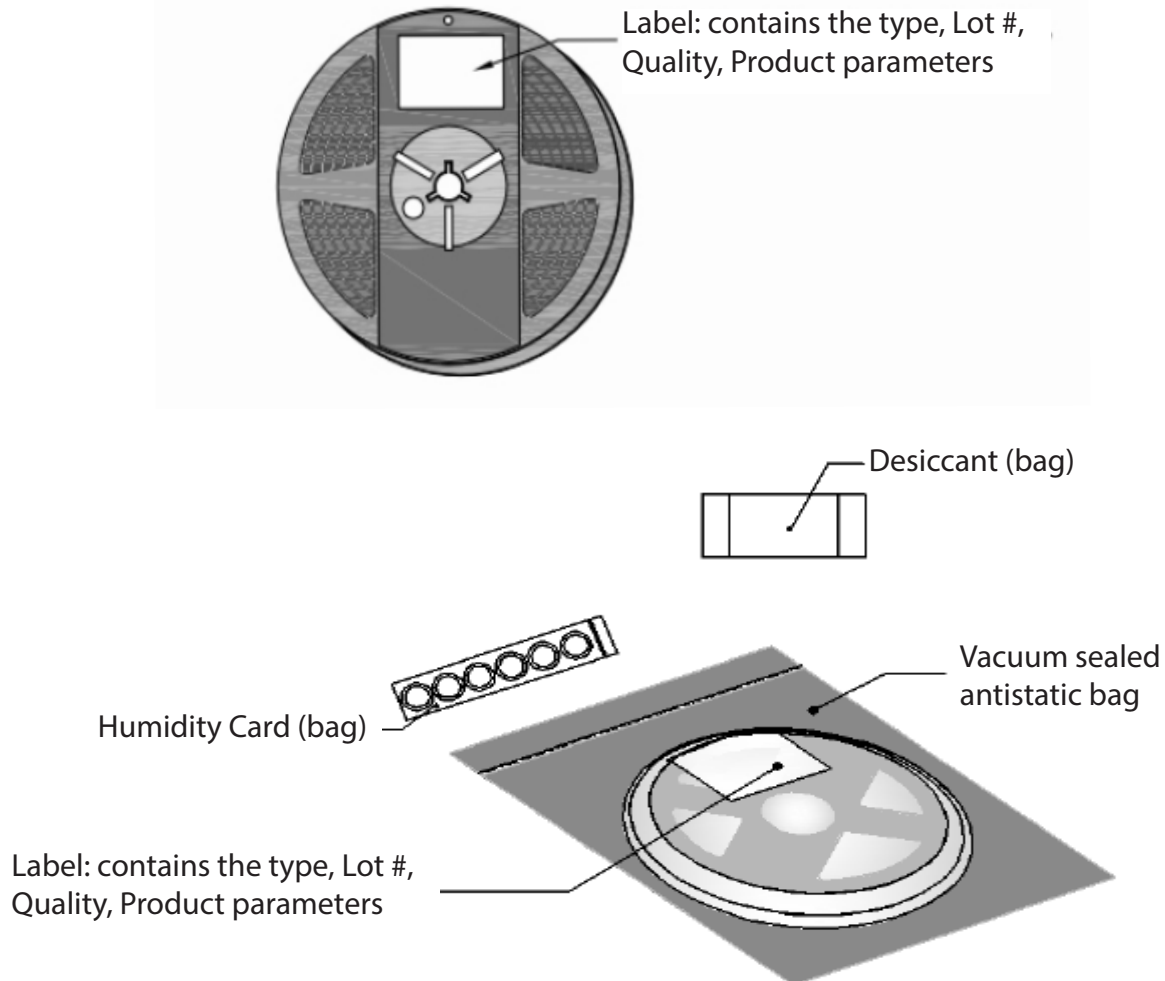
Reflow Soldering

Temperature Min (T_{smin})	138 °C
Temperature Max (T_{smax})	187 °C
Time(ts)from (T_{smin} to T_{smax})	60-120 seconds
Ramp-up rate(T_L to T_p)	3 °C/seconds max
Liquidoustemperature(T_L)	195 °C
Time(t_L) maintained above T_L	60-150 seconds
Peak package body temperature(T_p)	205 °C max
Time (t_p) within 5°Cof the specified classification temperature(T_c).	30 seconds max
Ramp-down rate(T_p to T_L)	6 °C/second max
Time 25 °C to peak temperature	8 min max

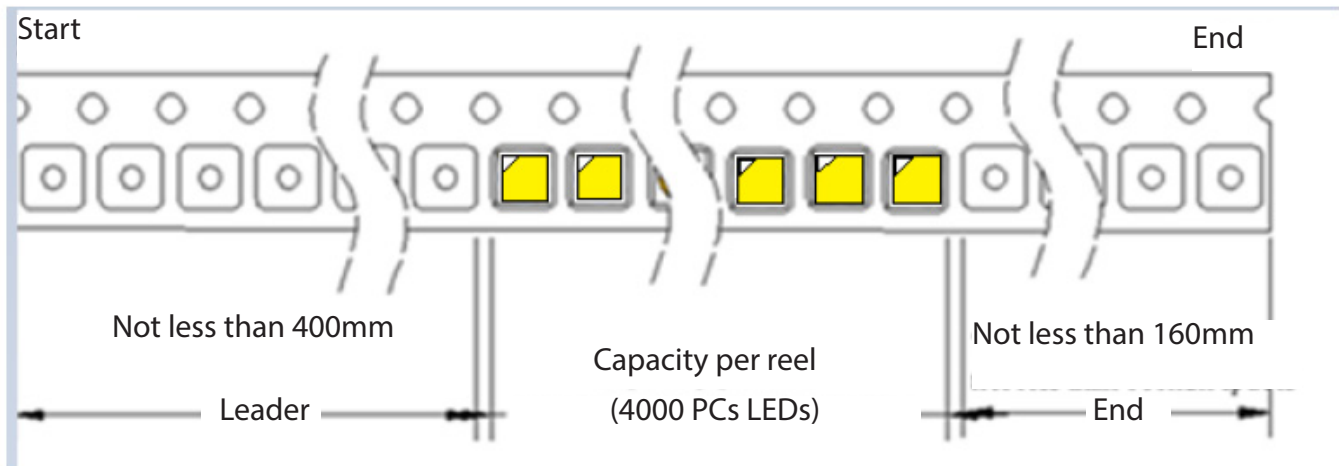
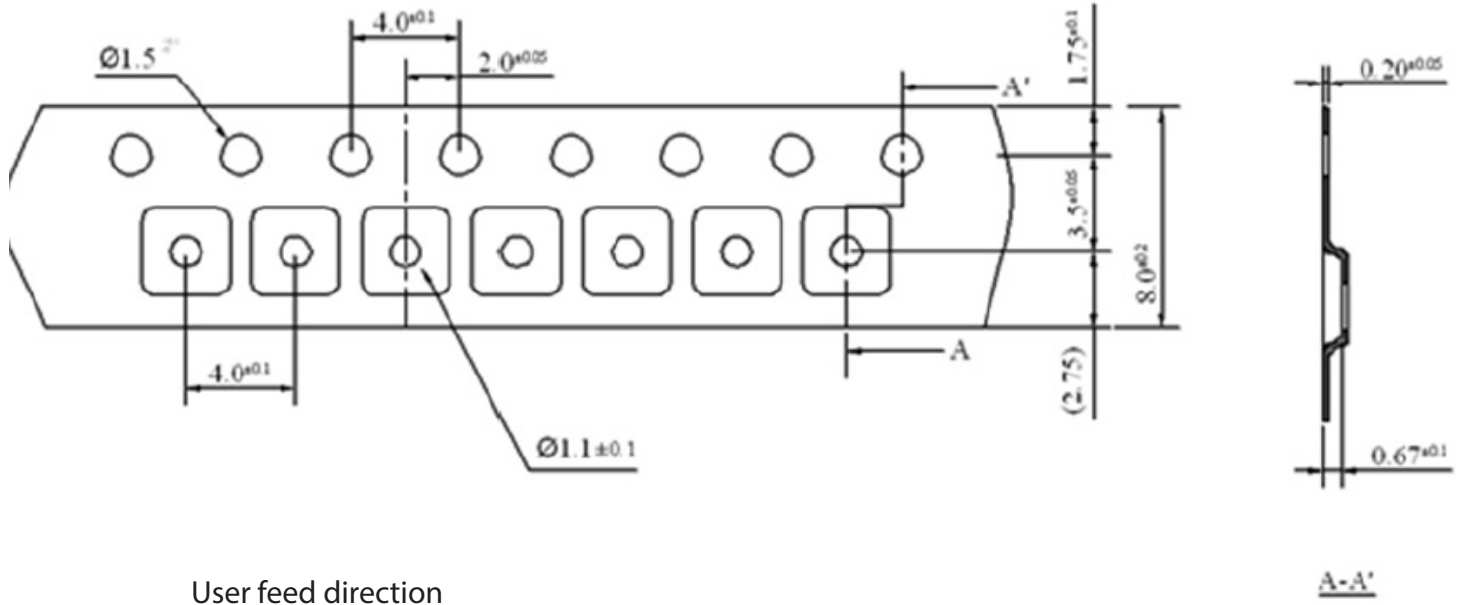
Package Dimensions of Reel (mm)

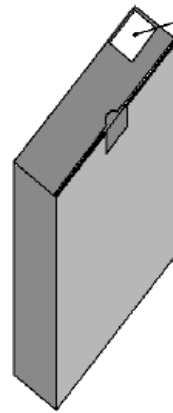
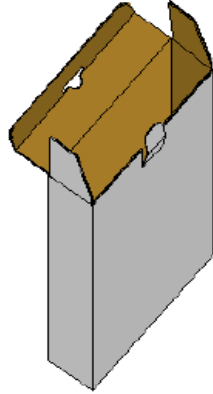
Package Dimensions of Reel (mm)

Package Dimensions Of Tape(mm)

Box Packaging

Label: contains the type,
Lot #, Quality, Product
parameters

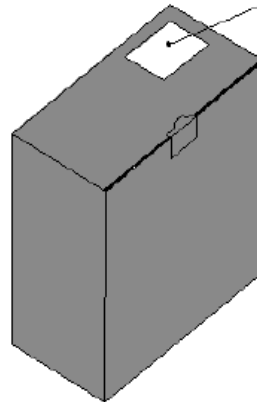
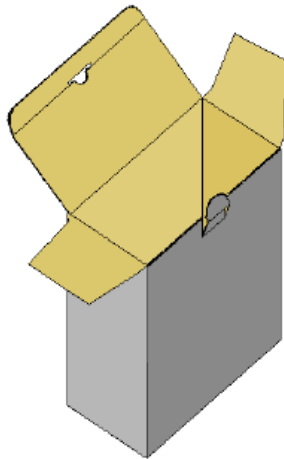
*Capacity 5 reels per box



Label: contains the type,
Lot #, Quality, Product
parameters

*Capacity 10 reels per box

Precaution for Use

Storage:

1. This device is rated at MSL 3 per JEDEC J-STD-020 standard.
2. Recommended storage condition:
At 5 °C- 30 °C and relative humidity 60% RH in its original package
3. After this bag is opened, devices that will be applied to infrared reflow, vapor - phase reflow, or equivalent soldering process must be:
 - a) Completed within 168 hours
 - b) Stored at less than 60%RH
 - c) If not completely used within 168 hours, seal the remaining in the moisture barrier bag
4. Devices require baking before mounting, if 3 a) is not met.
5. If baking is required, devices must be baked under below conditions:
24 hours at 60C+/-5C

Static Electricity:

1. The products are sensitive to static electricity, and care should be taken when handling them.
2. Static electricity or surge voltage will damage the LEDs. It is recommended to wear a anti-electrostatic wristband or an anti-electrostatic gloves when handling the LEDs.
3. All devices, equipment and machinery must be properly grounded. It is recommended that measures be taken against surge voltage to the equipment that mounts the LEDs.